



---

*Habitat Congress Building America:*

**HOT-HUMID CLIMATE CASE STUDY**

*for Lake Charles, Louisiana*



## HABITAT CONGRESS BUILDING AMERICA

Hot-Humid Climate Case Study for Lake Charles, Louisiana

Building Science Consortium  
70 Main Street  
Westford, Massachusetts 01886

Copyright © 2006 Building Science Corporation

## NOTICE

This report was prepared as an account of work sponsored by an agency of the United States government. Neither the United States government nor any agency thereof, nor any of their employees, makes any warranty, express or implied, or assumes any legal liability or responsibility for the accuracy, completeness, or usefulness of any information, apparatus, product, or process disclosed, or represents that its use would not infringe privately owned rights. Reference herein to any specific commercial product, process, or service by trade name, trademark, manufacturer, or otherwise does not necessarily constitute or imply its endorsement, recommendation, or favoring by the United States government or any agency thereof. The views and opinions of authors expressed herein do not necessarily state or reflect those of the United States government or any agency thereof.

## Contents

<b>HOW TO USE THIS PACKAGE</b>	1
<b>SECTION 1: INTRODUCTION</b>	3
Climate-specific Design	3
Building for a Hot-Humid Climate	4
Building Science for the Hot-Humid Climate House	8
<b>SECTION 2: THE BASIC HOT-HUMID CLIMATE HOUSE</b>	11
Description of the House	12
Siting and Orientation	14
Energy Analysis Overview	15
Building Enclosure	20
Mechanical Systems	34
Appliances and Lighting	43
<b>SECTION 3: ADVANCED TECHNOLOGIES FOR HOT-HUMID CLIMATE</b>	45
Energy Analysis Overview	45
Geothermal Heating and Cooling	48
Solar Hot Water	50
Photovoltaic Panels	54
Towards Zero Energy	57
In Conclusion	60
<b>RESOURCERS FOR BUILDERS IN A HOT-HUMID CLIMATE</b>	61
<b>APPENDIX: ACCA MANUAL J CALCULATIONS</b>	65

## Attachments

### **HOT-HUMID CLIMATE DRAWING PACKAGE**

A-1: Foundation and First Floor Framing

A-2: First and Second Floor Plans and Wall Framing Elevations

A-3: Second Floor Framing, Roof Framing and Roof Plan

A-4: Building Section AA

A-5: Building Section BB and Wall Section

A-6: Building Elevations

A-7: Details

M-1: Mechanical Plan

E-1: Electrical Plan

## How to Use this Package

This package has just about everything that you need to plan a high-performance Hot-Humid climate house.

The drawing set gives you an architectural description of the house from the foundations up to the roof. The floor plan layout shows special attention to the quality and character of the rooms, giving the future occupant a comfortable living space in an affordable way. The ground floor of the house can be easily converted to a fully accessible living area.

The plans also describe the house framing system in some detail. The structural design makes use of advanced framing techniques, which save material, minimize waste and increase thermal performance. The service pathways have also been considered. The building enclosure has been detailed to manage water, heat and air, making the house design energy-efficient, durable and comfortable.

Electrical and mechanical drawings are provided. The lighting, ventilation, space heating and domestic hot water systems have been designed with a whole house energy model that considers the building enclosure and the climate. Trade-offs have been made to get excellent performance while keeping the systems affordable, and examples of equipment are given to help you put the systems together.

The team of architects, engineers and building scientists that designed this set of house plans meant for all this information to be used together as a complete design.

But the package doesn't have everything – there is important work for you to do. Every homeowner has particular needs, and these should be reflected in the final plans and material choices. And just as design, material selections, and construction details may change from one climate zone to the next, local environmental factors in your specific location or even on one building lot can lead to changes not covered by this package. Professional judgement and common sense are required to address these issues.

To help, we have explained our design decisions in the text that accompanies the drawings. In the first part of the text, which describes the Basic Hot-Humid Climate House, you will find a step-by-step explanation of how we applied climate-specific design and building science principles. The second

section describes advanced technology packages that can be added to further increase the energy savings achieved by the basic house. At every step, we show you how our decision-making was guided by the whole house energy model.

With all of this, you will be well on your way to creating a high-performance home that is safe, healthy, durable, comfortable, and economical to operate.

## Section 1: Introduction

The Habitat Congress Building America Case Study Houses are designed to be climate-specific, affordable, energy-efficient housing prototypes. As a Building America house, the design also works towards the following objectives:

- Produce homes that use 30 to 50 percent less energy.
- Reduce construction time and waste by as much as 50 percent.
- Improve builder productivity.
- Provide new product opportunities to manufacturers and suppliers.
- Implement innovative energy- and material-saving technologies.

To reach these objectives, the basic Hot-Humid Climate house plan presented in this package uses a systems engineering approach. This means that a significant amount of analysis and refinement has gone into the design. The Building America design team has considered the interaction between the building site, envelope, mechanical systems, and other factors, recognizing that one feature of the house can greatly affect others. The team has then evaluated its design, business, and construction practices to identify cost savings, which have then be reinvested to improve energy performance and product quality.

There are two influences on this process that should be explained before you examine the Hot-Humid Climate house plan: an understanding of the regional climate, and building science knowledge and experience.

### CLIMATE-SPECIFIC DESIGN

Houses should be designed to suit their environments. In the home-building industry, we have accepted that design and construction must be responsive to varying seismic risks, wind loads and snow loads. We also consider soil conditions, frost depth, orientation and solar radiation. Yet we typically ignore the variances in temperature, rainfall, exterior and interior humidity and their interaction.

The Habitat Congress Building America houses are designed for a specific hygro-thermal region, rain exposure and interior climate. This means that the building enclosure and mechanical systems that are recommended in this package are generally suited to the Hot-Humid climate region. You can find a description of the North American annual rainfall and hygro-thermal regions on the climate maps that follow. Notice that while there are similarities between regions, there are also differences. It is cold and dry in Wyoming; it is cold and somewhat wet in Wisconsin. Local climate may also differ significantly from the regional climate descriptions, and if so, the differences must be addressed when implementing the house design provided here.

## BUILDING FOR A HOT-HUMID CLIMATE

A Hot-Humid climate is defined as a region that receives more than 20 inches of annual precipitation and where one or both of the following conditions occur:

- A 67°F (19.5°C) or higher wet bulb temperature for 3,000 or more hours during the warmest 6 consecutive months of the year, or
- A 73°F (23°C) or higher wet bulb temperature for 1,500 or more hours during the warmest 6 consecutive months of the year.



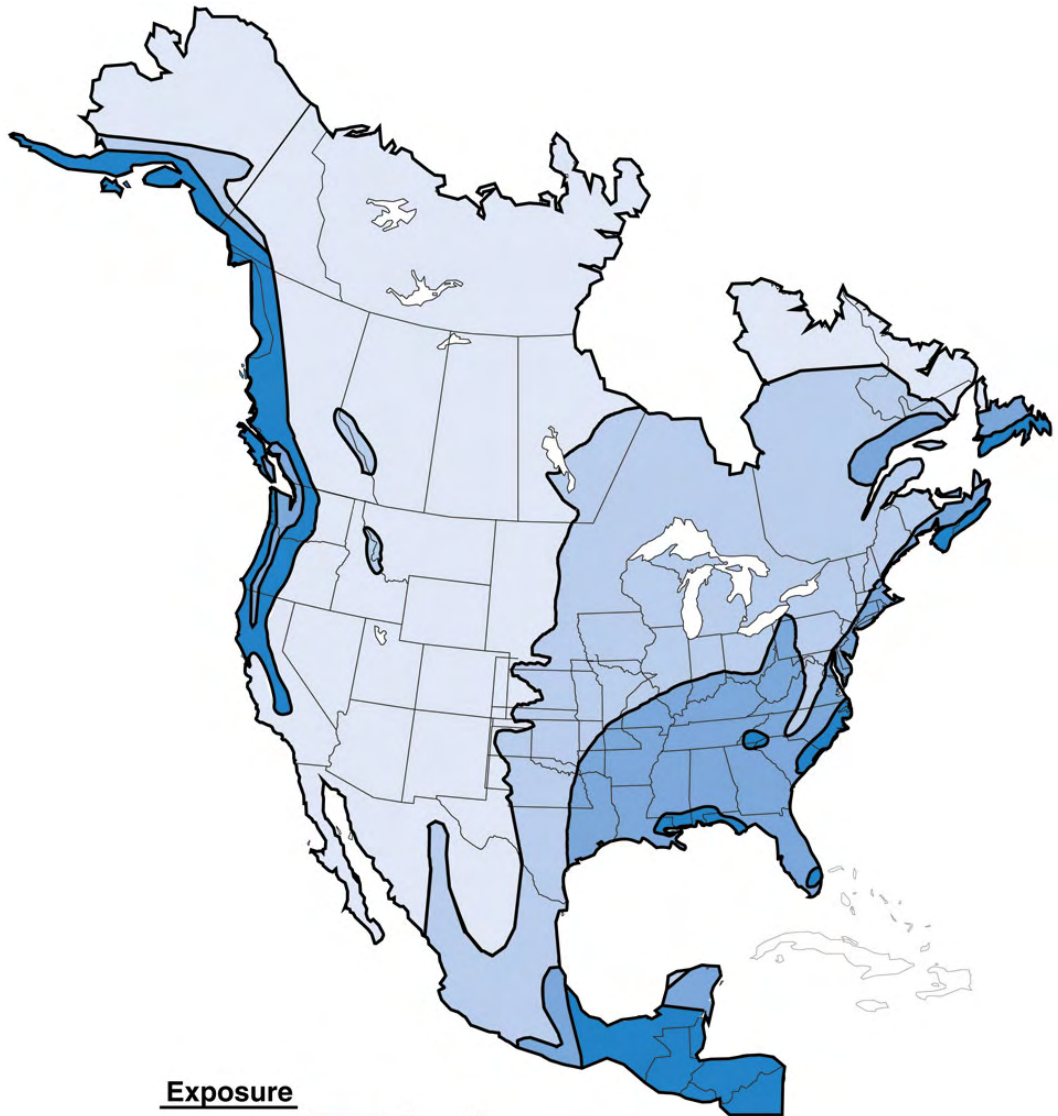

The intense solar radiation in this climate imposes a large thermal load on the house that can increase cooling costs and affect comfort. The approach presented in this package minimizes the impact of solar radiation on the building, its mechanical system, and its occupants. Moisture is a significant problem in this climate, more so in those areas that receive more than 40 inches of annual precipitation. The ambient air has significant levels of moisture most of the year. Because air conditioning is installed in most new homes, cold surfaces are present on which condensation can occur. Controlling the infiltration of this moisture-laden air into the building envelope and keeping moisture away from cold surfaces are major goals of design and construction. Housing types vary greatly throughout all of the different climate zones, but nowhere is the contrast so great as in the Hot-Humid climate of the south-eastern United States.

*Note: Don't forget that it is always the conditions that you actually experience in your area that determine the appropriate building design and construction details. The Building America Climate Zones provide simplified groupings of geographic locations that may actually vary greatly in terms of weather, and therefore should be viewed as guidelines.*





**Exposure**

Extreme		Over 60" Rain Screen
High		40" - 60" Rain Screen
Moderate		20" - 40" Drainage Plane/Drainage Space
Low		Under 20" Face Seal

*Map 1: Annual Precipitation – North America*



Map 2: The Building America Hygro-Thermal Regions

## Legend

### Subarctic/Arctic



A subarctic and arctic climate is defined as a region with approximately 12,600 heating degree days (65 F basis) or greater

### Very Cold



A very cold climate is defined as a region with approximately 9,000 heating degree days (65 F basis) or greater and less than approximately 12,600 heating degree days (65 F basis)

### Cold



A cold climate is defined as a region with approximately 5,400 heating degree days (65 F basis) or greater and less than approximately 9,000 heating degree days (65 F basis)

### Mixed-Humid



A mixed-humid climate is defined as a region that receives more than 20 inches of annual precipitation, has approximately 5,400 heating degree days (65 F basis) or less, and where the monthly average outdoor temperature drops below 45 F during the winter months

### Hot-Humid



A hot-humid climate is defined as a region that receives more than 20 inches of annual precipitation and where one or both of the following occur:

- a 67 F or higher wet bulb temperature for 3,000 or more hours during the warmest six consecutive months of the year; or
- a 73 F or higher wet bulb temperature for 1,500 or more hours during the warmest six consecutive months of the year<sup>†</sup>

### Hot-Dry



A hot-dry climate is defined as a region that receives less than 20 inches of annual precipitation and where the monthly average outdoor temperature remains above 45 F throughout the year

### Mixed-Dry



A mixed-dry climate is defined as a region that receives less than 20 inches of annual precipitation, has approximately 5,400 heating degree days (50 F basis) or less, and where the monthly average outdoor temperature drops below 45 F during the winter months

### Marine



A marine climate meets all of the following criteria:

- A mean temperature of coldest month between 27 F and 65 F
- A warmest month mean of less than 72 F
- At least four months with mean temperatures over 50 F
- A dry season in summer. The month with the heaviest precipitation in the cold season has at least three times as much precipitation as the month with the least precipitation in the rest of the year. The cold season is October through March in the Northern Hemisphere and April through September in the Southern Hemisphere.

<sup>†</sup> These last two criteria are identical to those used in the ASHRAE definition of warm-humid climates and are very closely aligned with a region where the monthly average outdoor temperature remains above 45 F throughout the year.

## BUILDING SCIENCE FOR THE HOT-HUMID CLIMATE HOUSE

An understanding of the regional climate is the starting point for the design of affordable, high-performance homes. Applying building science is the next step to create houses that are safe, healthy, durable, comfortable, and economical to operate. For the Hot-Humid Climate Case Study House, this means understanding and managing the way that four things move on or through homes:

- Water,
- Vapor,
- Air, and
- Heat

Section Two of this package, The Basic Hot-Humid Climate House, focuses on these four phenomena. The greatest risks for moisture-related problems are discussed and where possible, the reasoning behind the selection of enclosure assemblies is given. The house design is based on experience with what works and what does not work, from forensic investigations of building failures, and from the results of test houses and thousands of houses constructed by builder partners of the Building America program.

To bolster your own professional judgment and building common sense, the following ten building science principles are offered. It should not be a surprise that all of these principles are at least indirectly related to moisture. Even in hot-dry climates, moisture events related to occupant activities, leaks, and singular climate events can bedevil the performance and durability of today's homes.

1. Our efforts to save energy and reduce the flow of heat through building assemblies have reduced drying potentials and, therefore, increased the importance of controlling moisture flow through building assemblies.
2. Ideally, building assemblies should be designed to dry to both the interior and exterior. In heating climates, the primary drying potential is to the exterior (but not necessarily exclusively so); in cooling climates, the primary drying potential is to the interior (but not necessarily exclusively so); and in climates with both heating and cooling, some drying potential in both directions is typically a good idea (but not necessarily exclusively so).
3. Building materials last longer when their faces are exposed to similar or equal temperature and humidity. This is why the ventilation of

claddings, particularly those that store moisture (reservoir claddings), can be important.

4. Drainage planes, air barriers, and thermal barriers should be continuous to be truly effective. Being able to trace each of these on a full elevation drawing without lifting your finger (or pencil or pointer) from the elevation is a good test of continuity.
5. In moisture control, the priority is liquid water first, particularly when it comes in the forms of rain and groundwater. In these forms it is referred to as “bulk” water. Following in importance are air-transported vapor and then diffusive vapor. It’s always a question of quantities and rates, of wetting and drying, and the tolerance of materials (individually and in combination) for each and all of the above.
6. Three things destroy materials in general and wood in particular: water, heat, and ultraviolet radiation. Of these three, water is the most important by an order of magnitude.
7. When the rate of wetting exceeds the rate of drying, accumulation occurs.
8. When the quantity of accumulated moisture exceeds the storage capacity of the material or assembly, problems occur.
9. The storage capacity of a material or assembly depends on time, temperature, and the material itself.
10. The drying potential of an assembly decreases with the level of insulation and increases with the rate of air flow (except in the case of air flow in severe cold climates during cold periods where interior moisture levels are high).

1: Introduction

2. The Basic House

3. Advanced Technologies

## Section 2: The Basic Hot-Humid Climate House



*Figure 1: Perspective of the Lake Charles Hot-Humid Climate House*

## DESCRIPTION OF THE HOUSE

The case study house is a 1255 square foot, three bedroom, one-and-a-half-story single-family detached house raised on a pier foundation.

The ground floor has two entrances: one from the large porch at the front of the house, and the second to a smaller deck at the garage side of the rear of the house. All of the essential rooms in the house are located on the ground floor making a conversion to a fully accessible home possible.

The perspective drawing on the previous page shows the prototype house for Lake Charles raised off of the ground by structural piers. The pier foundation is intended to comply with the FEMA design guidelines for flood-prone areas. The design reflects lessons learned about building in hurricane-prone coastal areas, including:

- Elevate structures and mechanical equipment
- Build with materials that are non-water sensitive
- Design assemblies to easily dry once wet

The following sections will explain how these lessons are applied to the building details.

On the second floor, the drawings show a second bathroom off the hallway at the top of the stairs and two bedrooms to the front and back of the house. Since all of the mechanical systems are located downstairs and all of the insulation is located outside of the framing, the ceilings on this floor may be left open to make the bedrooms feel larger. At both sides of each bedroom, knee walls can be added to provide large closets for storage. The stairwell, the bedrooms, and the second floor bathroom are given more floor area by dormers on either side of the roof peak.

A high-performance, energy-efficient house depends on rational and efficient space planning. The Lake Charles Hot-Humid Climate house plan presented here is organized to simplify construction and reduce the materials and operating costs. However, it does this while still providing the homeowner with a convenient layout and large, spacious rooms. Attention to architectural design, it should be noted, is one way of securing a high-quality, affordable and comfortable home.

The following section discusses how the building enclosure and mechanical systems have been designed help this house be durable, healthy and energy-efficient.



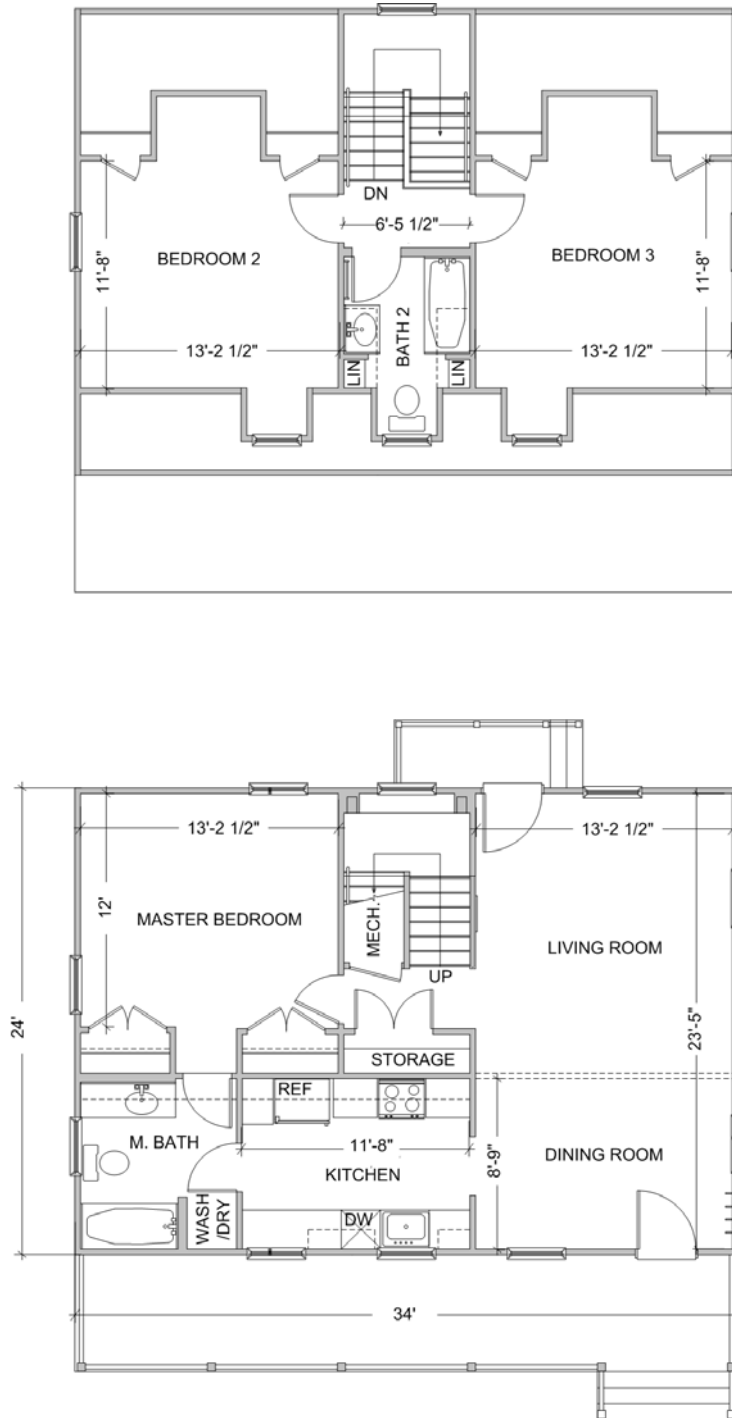

Figure 2: Hot-Humid Climate house floor plans (Bottom: Ground Floor, Top: Second Floor)

## SITING AND ORIENTATION

The choice of an appropriate building site is an important first step in constructing the affordable, high-performance house described in this package.

In selecting a site, priority should be given to urban lots with existing service infrastructure, access to public transportation and mature neighborhood amenities. The next best choice would be a lot in a responsibly-planned new development. In either location, the building site should be chosen for good solar access, with consideration given to orientation, slope, existing or potential overshadowing, and lot proportions.

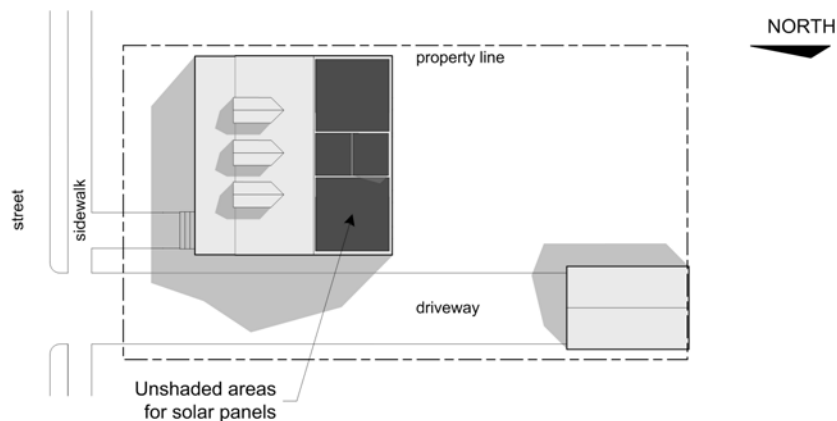

Figure 3: Site Plan Diagram

The site plan above shows an area for installing solar thermal or photovoltaic panels on the south face of the house rooftop that will not be shaded by neighboring buildings. Large roof overhangs shade the walls and windows of the house to reduce the summertime cooling load. The garage is located towards the rear of the property to provide an additional or alternate location for PV panels.

In a Hot-Humid climate, landscaping should be arranged to shade the house from early morning and peak afternoon sun further reducing the energy needed to cool the building. Note that the shading should not extend over any part of the solar panels (PV), as a small amount of shading can significantly reduce their output. Well placed trees and other planting can create a cool microclimate around the house.

In flood zone or coastal areas, all floor levels need to be built above the flood plain and extra attention should be given to the grading of the site to ensure that water is carried away from the house.

## ENERGY ANALYSIS OVERVIEW

An energy analysis was done for the house plan to examine the energy consumption of the building. With any energy analysis a start point for comparison is required.

The Building America Benchmark Definition Version 2005 along with recent revisions was used as a template for performance evaluation between the advanced building system (Prototype) and the reference building system (Benchmark). The Benchmark Definition requires hourly building energy simulation.

The Building America Benchmark Protocol is generally consistent with mid 1990's house construction. Unlike other rating performance systems, the Building America Benchmark includes not only heating, cooling and hot water, (which accounts for roughly 50% of total energy consumption of the home), but also energy consumption from lighting, appliances, and other miscellaneous loads.

The following table highlights the differences between the Building America Benchmark House design characteristics and the Prototype design characteristics that were incorporated into this house design.

	Benchmark	Prototype
<i>Building Enclosure</i>	R-13, 16" oc R-20 Roof Insulation Low E Windows (U=0.79, SHGC=0.65) R-12 Raised Floor Insulation BM Airtightness (~5 in <sup>2</sup> /100 sf)	R-10 Foam Sheathed 2x4 Walls R-20 Foam over Roof Deck Low E Windows (U=0.33, SHGC=0.3) R-10 Foam under Floor Framing BSC BA Airtightness (2.5 in <sup>2</sup> /100 sf)
<i>Mechanical</i>	6.8 HSPF ASHP 10 SEER A/C System R-5 Ducts in attic, 15% Leakage 0.88 EF Electric Tank Hot Water ASHRAE 62.2 Exhaust Fan	8.5 HSPF ASHP 14 SEER Cooling System Ducts in Conditioned Space 0.94 EF Electric Hot Water Tank ASHRAE 62.2 Ventilation by FanCycler
<i>Appliances and Lights</i>	90% Incandescent Lighting Regular Appliances	90% Fluorescent Lighting ENERGY STAR Appliances

The simulation program used to run the energy model was EnergyGaugeUSA version 2.42 from the Florida Solar Energy Center.

The areas of consideration fall under three main categories, the Building Enclosure, Mechanical Systems, and Appliances and Lights. A parametric whole house energy analysis was done for the case study house design to illustrate the relative importance of the upgrade strategies in each of the three main areas.

The case study model design achieved a whole house 39.2% energy reduction when compared to the Building America Benchmark.

Table 1: Parametric Analysis Results

Parametric Run ID	Description of change	Estimated Individual Cost of change	Estimated Cumulative Cost of change	Total Source Energy Savings (H/C/DHW/Lights/Appliances/Plug)					
				over BA Benchmark1	Incremental Over Bmrk	Annual energy cost	Item Savings	Simple payback (yr)	Increment payback (yr)
0	Benchmark	n/a	n/a	n/a	n/a	\$1,855	n/a	n/a	n/a
1	0 + Windows as-designed, w/overhangs	n/a	n/a	3.4%	3.4%	\$1,792	n/a	n/a	n/a
2	1 + Air seal	\$200	\$200	10.5%	7.1%	\$1,657	\$198	1	1
3	2 + Ducts in cond. space, 5% leakage	\$200	\$400	17.0%	6.5%	\$1,535	\$122	1	2
4	3 + Ventilation air added (46 CFM)	\$200	\$600	12.7%	-4.3%	\$1,616	(\$81)	3	-2
5	4 + R-10 walls	\$500	\$1,100	13.8%	1.1%	\$1,595	\$21	4	24
6	5 + R-20 roof	\$500	\$1,600	14.2%	0.4%	\$1,586	\$9	6	56
7	6 + R-10 pier foundation	\$500	\$2,100	14.0%	-0.3%	\$1,591	(\$5)	8	-100
8	7 + All windows Low-E2	\$500	\$2,600	19.6%	5.6%	\$1,485	\$106	7	5
9	8 + ASHP: 14 SEER / 8.5 HSPF	\$500	\$3,100	26.4%	6.8%	\$1,356	\$129	6	4
10	9 + 0.98 EF water heater	\$400	\$3,500	28.2%	1.8%	\$1,322	\$34	7	12
11	10 + CFL Lighting Package	\$200	\$3,700	34.8%	6.6%	\$1,221	\$101	6	2
12	11 + ES Appliances	\$300	\$4,000	39.2%	4.3%	\$1,137	\$84	6	4

Note that the estimated cost of change column is a net change, giving credit back for the replaced components. For example, the Benchmark mechanical system includes standard duct installation, standard efficiency heat pump, and hot water heater. Crediting the standard system, the high efficiency system with more air tight ducting and higher efficiency water heater would add \$1000 over the cost of the standard equipment.

Parametric Annual Loads Study

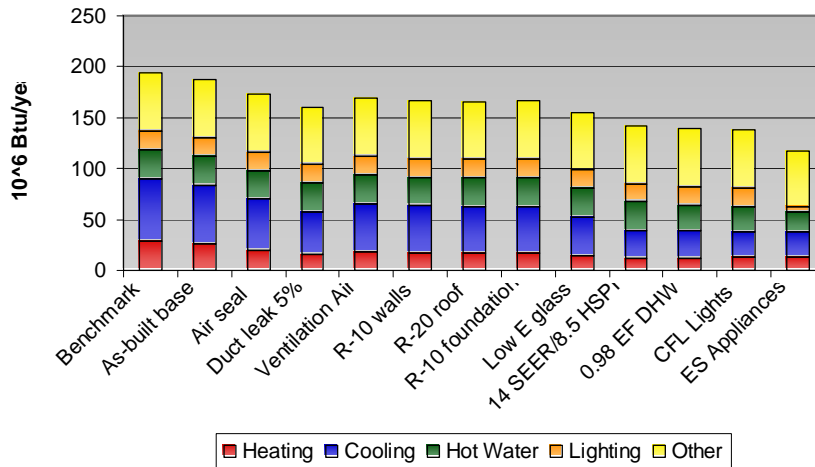

Figure 4: Total Source Energy Consumption Reduction

**Summary of End-Use Site-Energy**

End-Use	Annual Site Energy			
	BA Benchmark		Prototype 1	
	kWh	therms	kWh	therms
Space Heating	2811	0	1249	0
Space Cooling	5973	0	2465	0
DHW	2766		1844	
Lighting	1767		588	
Appliances + Plug	5573		5347	
Total Usage	18890	0	11493	0

**Summary of End-Use Source-Energy and Savings**

End-Use	Estimated Annual Source Energy		Source Energy Savings	
	BA Benchmark	Prototype 1	Percent of End-Use	Percent of Total
	106 BTU/yr	106 BTU/yr	Prototype 1 savings	Prototype 1 savings
Space Heating	29	13	56%	8%
Space Cooling	61	25	59%	19%
DHW	28	19	33%	5%
Lighting	18	6	67%	6%
Appliances + Plug	57	55	4%	1%
Total Usage	194	118	39%	39%

On the basis of BTU/sf/yr of site energy, the above calculations yield the following:

**Site Energy Use in BTU/sf for LA: 28605 CDH, 1437 HDD**

	Cooling	Heating	Total	Reduction
Benchmark	16.2	7.6	51.2	n/a
Building America	6.7	3.4	31.1	39%

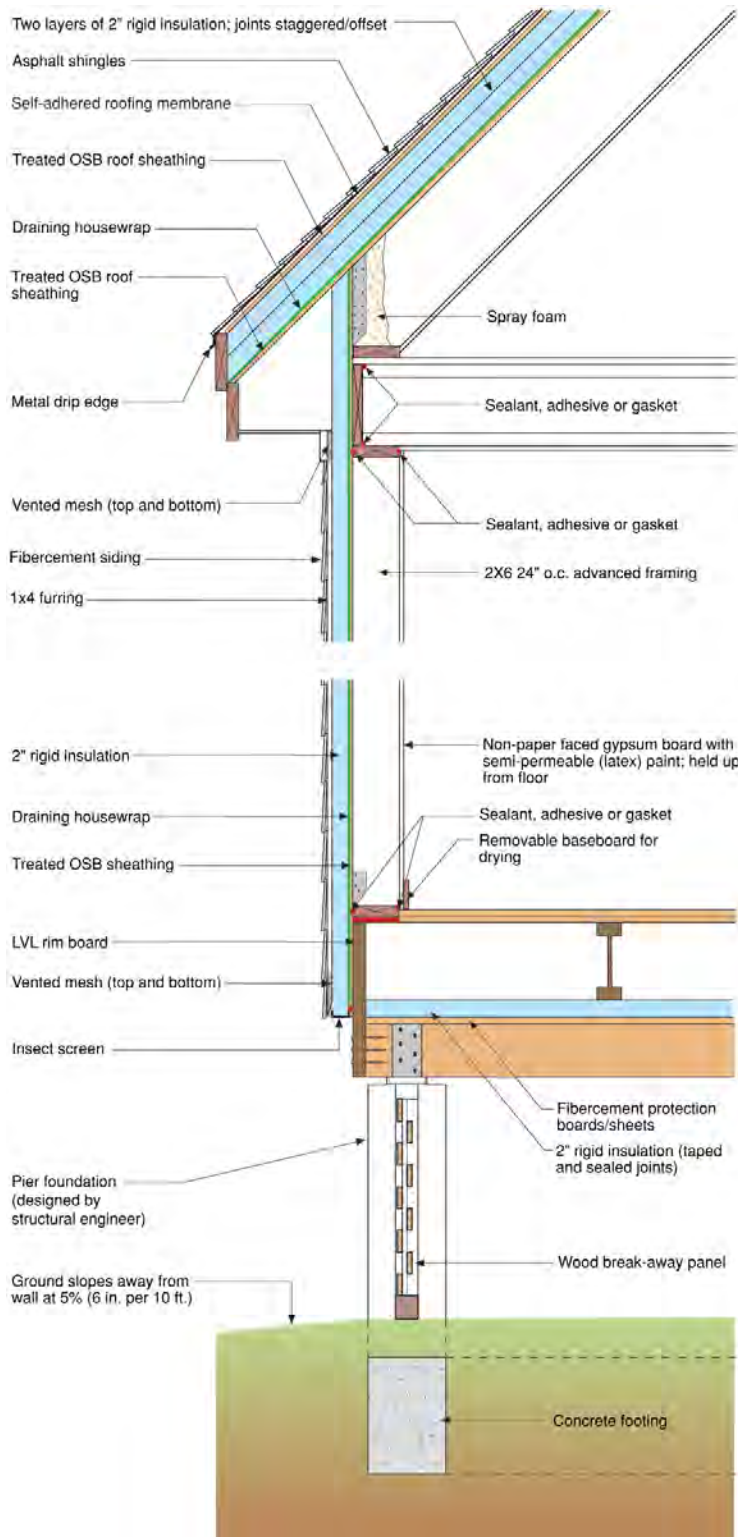
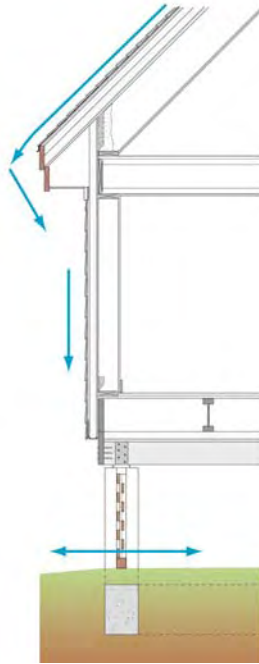
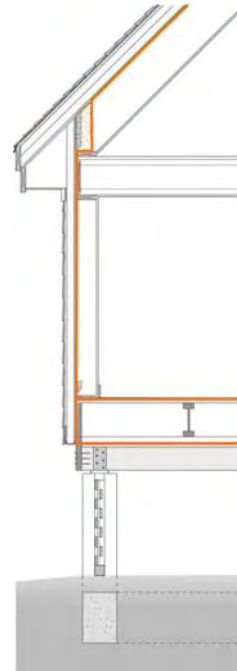

Figure 5: Building Section



*Drainage*



*Air Barrier*

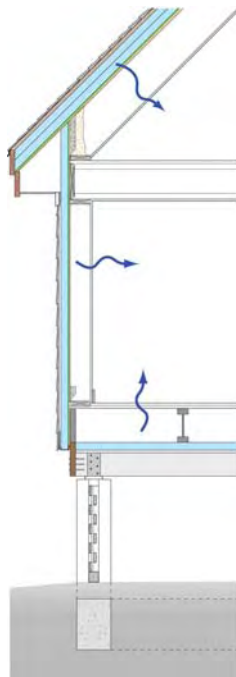

*Vapor Management*

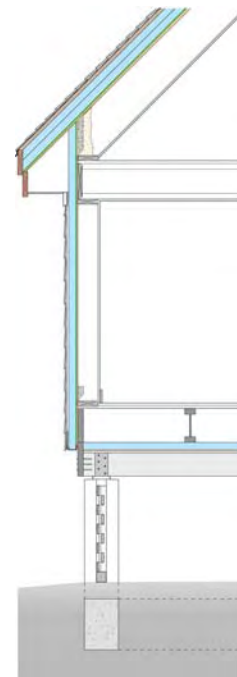

*Thermal Resistance*

## BUILDING ENCLOSURE

A fundamental part of durable, energy efficient, and sustainable construction is the design of the building enclosure. Water managed, thermally efficient, and leak free building enclosures, while providing for durable structures and reducing energy consumption, also allow us to maintain better control of our interior environmental conditions. In order to achieve this, the various components of the building enclosure (roofs, walls, foundations, windows and doors) must be designed to fulfill their individual requirements. However, these components must also be tied together in such a way as to create a complete system to control rain water, air leakage, vapor migration, and thermal transfer. In addition, the systems should be economical while still being robust enough to handle the various climate loads that are imposed on them.

Rain water infiltration is the largest source of material deterioration in buildings. The control of rain water is best achieved if some simple principles of drainage are followed. The fundamental design looks to create a means to drain water off the building, out of the assemblies and components, and away from the building. The design uses a strategy referred to as an open rain screen approach. In an open rain screen approach, the exterior primary layer of water shedding (cladding, shingles, metal roofing, etc) is not relied upon to be completely watertight. A secondary drainage layer (usually a housewrap or taped insulating sheathing) is installed behind the main exterior water shedding surface. This drainage layer, often referred to as a ‘drainage plane,’ in combination with flashing details allows water that may penetrate through the exterior water shedding layer to drain back out to the exterior.

1: Introduction

2: The Basic House

3: Advanced Technologies



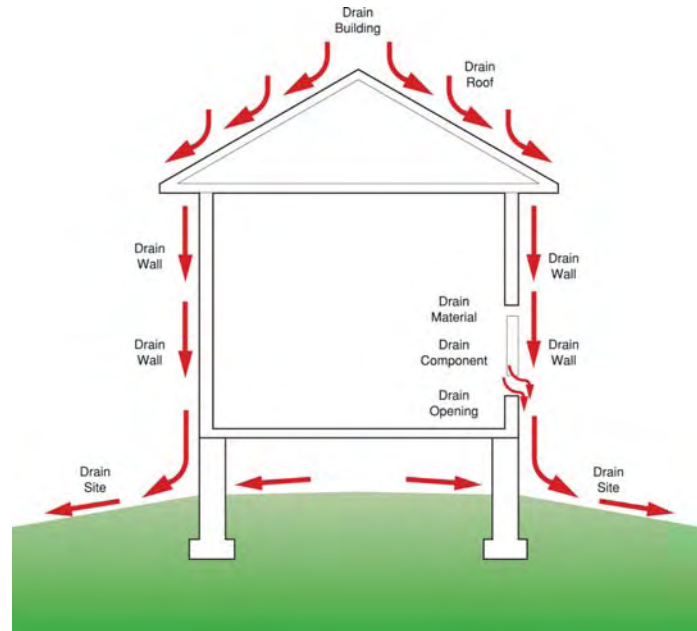

Figure 6: Diagram of Drainage

After liquid water intrusion, air leakage is the second most common mechanism for depositing moisture in wall assemblies. Air leakage occurs due to air pressure differentials causing air to flow through or within the building assembly. In order to control air leakage a continuous plane of airtightness should be created. This plane of airtightness or air seal should be continuous not only for each building assembly, but at the connection between adjoining building assemblies. Uncontrolled air leakage can also impact the energy efficiency of the building as infiltrating air will need to be conditioned or through the loss of exfiltrating conditioned air. The Building America goal is to achieve an infiltration rate equivalent to 2.5 square inches per 100 square feet of building enclosure area. Creating a continuous air seal is possible with special attention at transition details between different assemblies and systems.

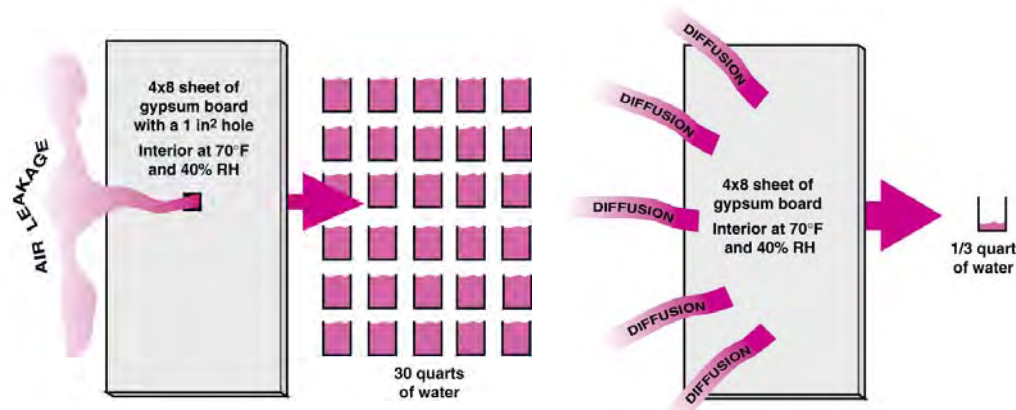

Figure 7: Moisture transport comparison

Vapor transport through diffusion can be a benefit or a detriment. In some circumstances, vapor diffusing into a wall assembly can condense and accumulate resulting in problems with material deterioration. On the other hand, vapor diffusion can also be used as a drying mechanism that will allow assemblies to dry to either the exterior or the interior or both. In general, the vapor control strategy used should maximize the drying potential of the assembly while minimizing the potential for wetting. With vapor diffusion being affected by both permeability of building components and temperature gradients across assemblies, the vapor control strategy is often related to, and integrated in, the insulation system design as well. For hot humid climates such as this, the assemblies are in general designed to prevent hot humid exterior air from diffusing into the assemblies, while allowing the assemblies to dry to the interior.

To control thermal transfer, the intention is to maximizing the thermal insulating value of all 6 sides of the building enclosure to levels that are suited for the climate zone while not becoming cost prohibitive. The thermal transfer is primarily managed by the insulation type, thickness, and location; however other aspects such as framing design, and window U-value and Solar Heat Gain Coefficient (SHGC) are important as well.

To keep the cost of the systems down, reducing material use in the assemblies and material waste on the project is important. This can be done by efficient layout of the house plan and efficient use of materials. Reducing material use must be done in such a way however so as not to affect the robustness or structural integrity of the building. Provisions to maintain adequate wind and seismic resistance must always be incorporated into the design.

This house is designed for coastal hurricane prone areas. These areas experience some of the highest wind loads as well as greatest flood potential.

To account for this, the building must be designed to transfer wind uplift forces from the roof structure, through the walls, and down to the foundation. Due to the corrosive nature of coastal climates, it is recommended to use stainless steel fasteners and brackets for locations exposed to the exterior conditions (all material exterior of the housewrap). Other coated metals such as double dipped galvanized fasteners and connectors can be used with increasing risk of corrosion. In addition, while it is reasonable to expect a house to be free of rain water leaks during normal storm events, it is not reasonable to expect that a house will not experience some wetting during a hurricane storm event. Therefore the house is designed to withstand periodic wetting and designed to promote rapid drying of the building materials.

### *Roof Design*

The roof is designed with asphalt shingle installed over a SBS roof membrane (similar to a W.R. Grace Ice and Water Shield) fully adhered to a layer of borate treated OSB. A primer may be required to facilitate the adhesion of the membrane to the OSB. While the shingles will ensure that the vast majority of the liquid rain water sheds off the surface, the waterproof membrane below the shingles will provide for added protection against water that may be blown up and under the shingles during high winds, or water that may creep up under the shingles due to capillary suction. The overhangs from the roof are designed to extend a minimum of 2 ½ feet from the exterior wall. This amount of overhang will provide protection for the wall elements such as windows and doors that are traditionally common sources of water leakage. With the overhangs preventing the wall systems from getting wet, the risk of water intrusion through these elements is greatly reduced.

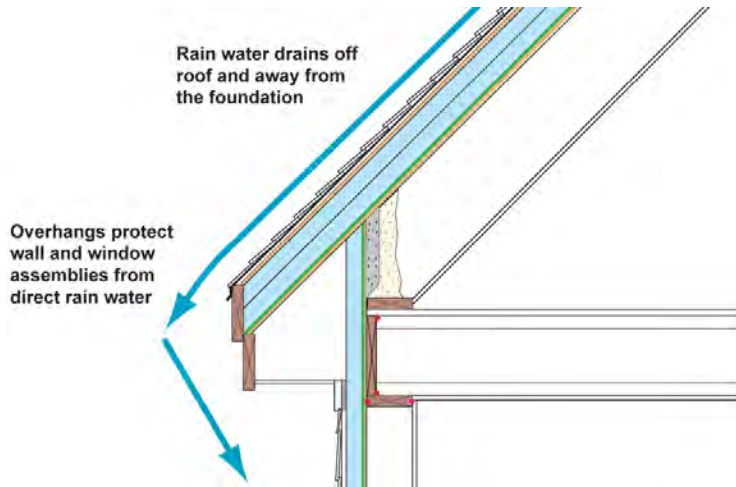

Figure 8: Roof Drainage

The attic is designed as an unvented attic. With unvented attics such as this, the plane of air tightness is located at the plane of roof and not at the ceiling plane as is common with vented attic designs. Since the attic is not vented to the exterior, soffit and ridge vents are NOT installed, and would in fact be detrimental to the performance of the system. The air tightness for this assembly is provided by the building paper or housewrap sandwiched between the rigid insulation and the interior layer of roof sheathing. In order to maintain the continuity of the air seal between the roof and the wall, some spray foam is installed from the underside of the roof deck to the top plate of the wall assembly.

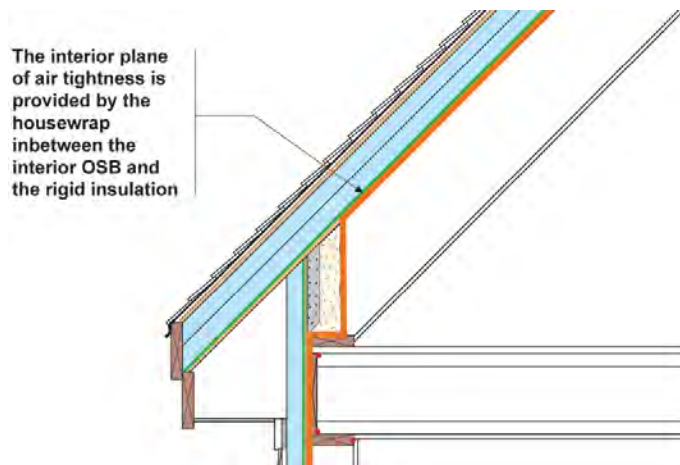

Figure 9: Roof Air Barrier

The fully adhered SBS membrane, while providing a waterproofing layer under the shingles, also has a perm rating of less than 0.1 perms, making it a Class 1 vapor retarder. This membrane will prevent exterior humidity or water absorbed by the shingles from diffusing into the roof construction from the exterior. The housewrap (usually considered to be a Class 3 vapor retarder or better) will allow for any moisture that may penetrate down to this plane of the assembly to dry to the interior.

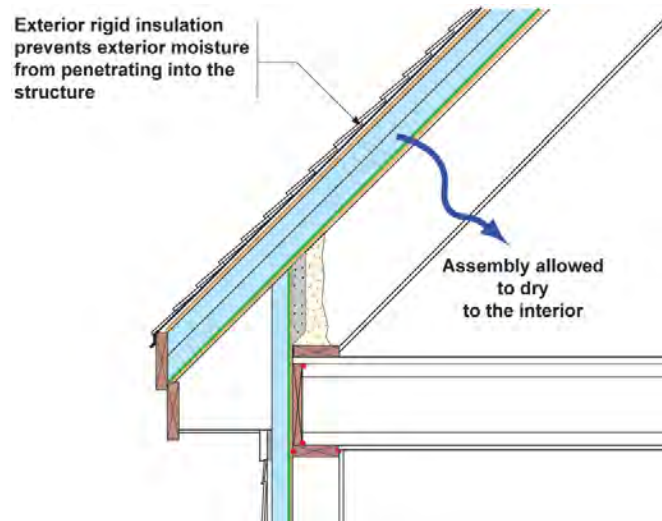

Figure 10: Roof Vapor Management

The thermal resistance of the assembly is provided by the 4 inches of rigid insulation installed to the exterior of the structure. Due to the high temperatures experienced by the roof, EPS insulation would not be appropriate for this system, the insulation should be either XPS or Polyisocyanurate. With cavity insulation, the framing members (studs, top and bottom plates, window headers, etc) are thermal bridges through the insulating layer. These thermal bridges can reduce the rated R-value of the insulation upwards of 35% to 40%. This means that a 2x6 stud wall with a rated R-19 fiberglass batt will in reality have an effective R-value of around R-13 for the entire assembly. For this design, since the insulation is installed exterior of the structure, concerns with thermal bridging of the framing members are essentially eliminated. This means that close to the entire rated insulating value of the insulation will be effective in providing thermal resistance. 4 inches of rigid XPS installed to the exterior of the structure will have an effective R-value of R-20.

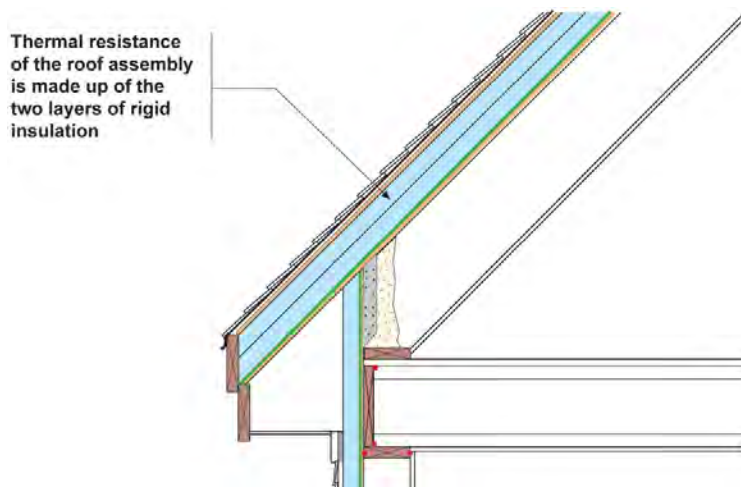

Figure 11: Roof Thermal Resistance

The spacing of the trusses is on 24 inch centers. The house is designed for high wind locations such as hurricane prone zones. Due to this the trusses are connected to a stud below with a hurricane tie to deal with the extremely high wind load potential for this area. The roof framing and sheathing are borate treated to resist rot and decay in the event the material gets wet. This treatment also protects the wood from insects such as termites.

### *Wall Design*

The wall water management system is designed with a ventilated and drained cavity behind the fiber cement siding. The fiber cement is held off of the rigid insulation with 1x4 furring strips. These furring strips provide for an air gap that acts both as a drainage gap and ventilation gap. This allows water that penetrates past the siding to drain to the exterior and allows for air flow behind the cladding to help with drying of the cavity. The drainage plane for the assembly is the housewrap behind the rigid insulation. Most water penetrating past the cladding will drain down the exterior face of the rigid insulation, however, some water may still get past at the joints in the rigid insulation boards. For this reason it is still important that the continuity and integrity of the housewrap drainage plane be maintained. All flashings should be tied back to this plane and shingle lapped into the housewrap.

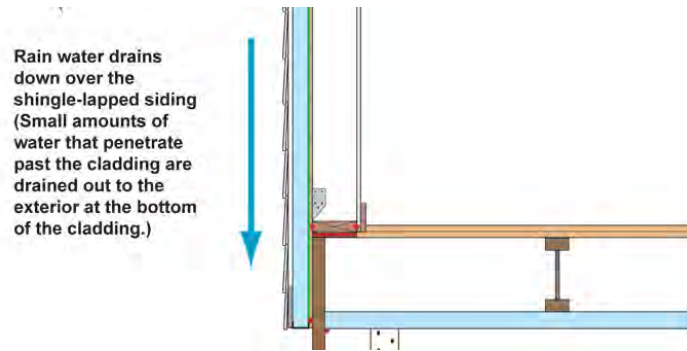

Figure 12: Wall Drainage

The air tightness for this assembly is provided by the housewrap sandwiched between the rigid insulation and treated OSB sheathing. The continuity is maintained at the top by sealing the exterior wood or gypsum sheathing to the top plate with a bead of sealant, and through sealing the top plate to the underside of the roof deck with spray foam insulation. At the connection to the floor, the exterior wood sheathing is sealed to the sill plate, and the sill plate is sealed to the floor structure at the sill gasket or with a continuous bead of sealant or adhesive.

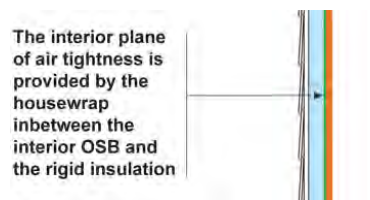

Figure 13: Wall Air Barrier

The primary vapor control element in this assembly is the exterior rigid insulation. All types of insulating sheathing can be used in this design due to the drying capacity to the interior provided by the gypsum, however insulating sheathing with lower permeability ratings such as XPS and Polyisocyanurate would help to limit the amount of moisture able to diffuse through the assembly. As an example, two inches of XPS insulation is considered to be a Class 2 vapor retarder (between 1.0 and 0.1 perms). A Class 2 vapor retarder is considered to be vapor semi-impermeable and limits the amount of exterior moisture able to diffuse through the assembly into the interior.

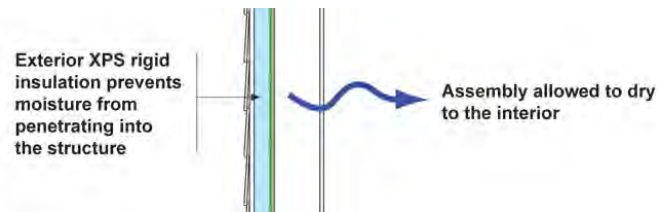

Figure 14: Wall Vapor Management

The thermal resistance of the assembly is provided by the 2 inches of rigid insulation installed to the exterior of the structure. As mentioned in the roof design section, with cavity insulation, the framing members can reduce the rated R-value of the insulation upwards of 35% to 40%. This means that a 2x6 stud wall with a rated R-19 fiberglass batt will in reality have an effective R-value of around R-13 for the entire assembly. For this design 2 inches of rigid XPS installed to the exterior of the structure will have an effective R-value of R-10.

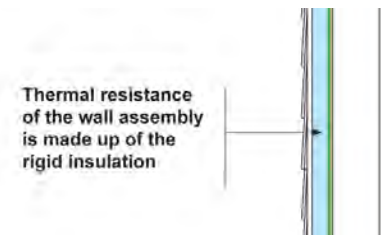

Figure 15: Wall Thermal Resistance

The layout of the walls on the floor plan follows a 24 inch grid. This 24 inch grid makes use of standard material dimensions for sheathing and insulation products. This reduces cutting and material waste on site. Following this, the walls are designed with the use of advanced framing techniques (advanced framing uses 2x4 studs at 24 inches on center, single top plates, two stud corners, and headers over windows only on load bearing walls). Where in other locations, the exterior wood sheathing can be removed to further reduce material use, in this case, due to the high potential wind loads of the area, the lateral load resistance is provided by completely sheathing the wall area with exterior treated OSB sheathing. Uplift forces must be transferred from the roof structure through to the foundation. At the top of the walls, the rafters are strapped to the studs past the top plate. At the foundation, the studs are strapped to the floor beam.

Similar to the roof sheathing, the wall framing and sheathing is also borate treated to resist rot and decay in the event the material gets wet, and to



protect the wood from insects such as termites. In the case of a wetting event, the bottom portion of the interior drywall can be removed to facilitate drying of the un-insulated wall cavity.

### *Foundation Design*

The foundation design is specific to areas with high flood probability. The floor is elevated off the ground on pier footings with panels that will blow out under severe weather conditions. This allows for the water to drain completely under the building without damaging the home. The design of the piers should reflect the soil conditions and scour potential of the area.

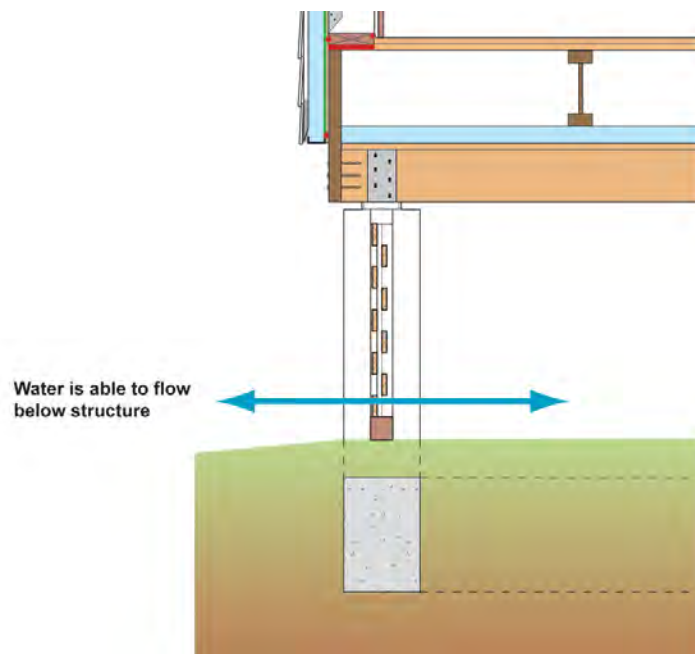

*Figure 16: Foundation Drainage*

The main air tightness is maintained by sealing the sub floor to the bottom plate of the stud wall. In addition to control the potential of condensation due to air leakage, all the joints of the rigid insulation installed to underside of the floor structure, are taped and sealed. The rigid insulation is also sealed to the beams of the foundation structure.

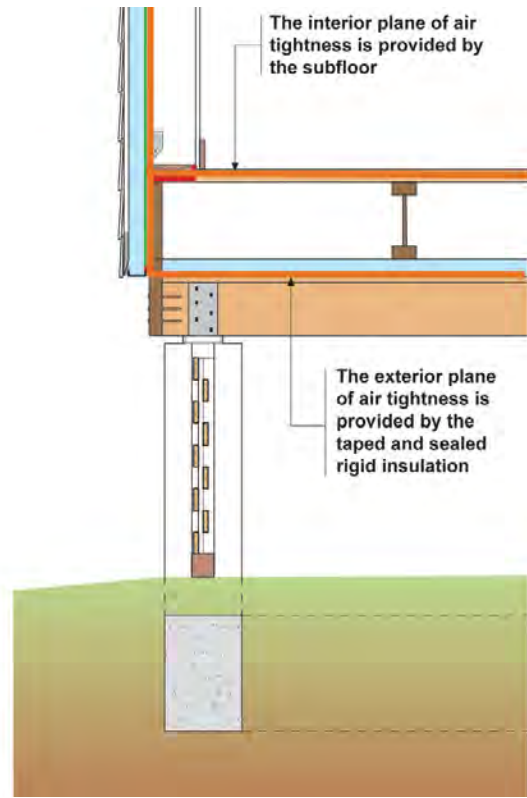

Figure 17: Foundation Air Barrier

As with the wall assembly, the vapor control is provided by the 2 inches of rigid insulation installed to the underside of the floor structure. However, unlike the wall assemblies, control of exterior water vapor diffusing into the assembly is more critical as the subfloor and floor finishes may limit the drying capacity of the assembly to the interior. Due to this only low permeability rigid insulation should be used. Both XPS and Polyisocyanurate insulation would be acceptable for this design. As an example, 2 inches of XPS insulation is considered to be a Class 2 vapor retarder (between 1.0 and 0.1 perms). A Class 2 vapor retarder is considered to be vapor semi-impermeable and would limit the amount of exterior moisture able to diffuse through the assembly into the interior.

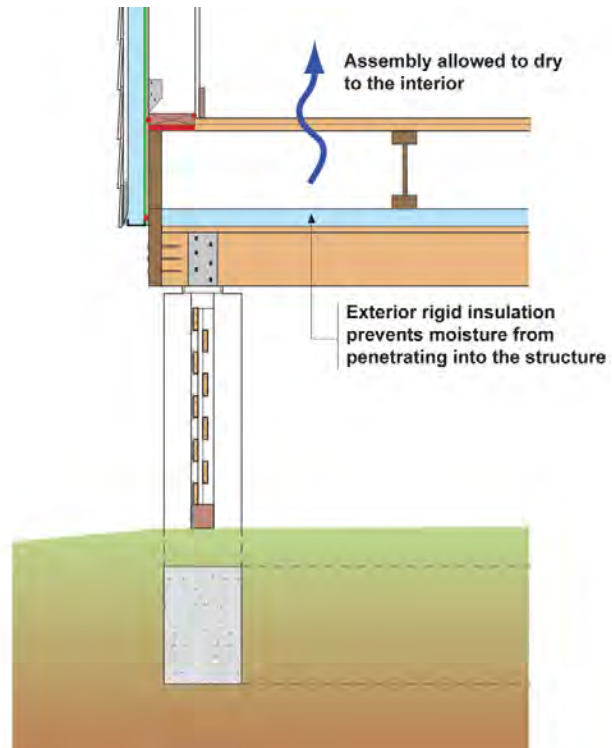

Figure 18: Foundation Vapor Management

Similar to the wall assembly, the thermal resistance of the assembly is provided by the 2 inches of rigid insulation installed to the underside of the structure. For this design 2 inches of rigid XPS installed to the underside of the structure will have an effective R-value of R-10.

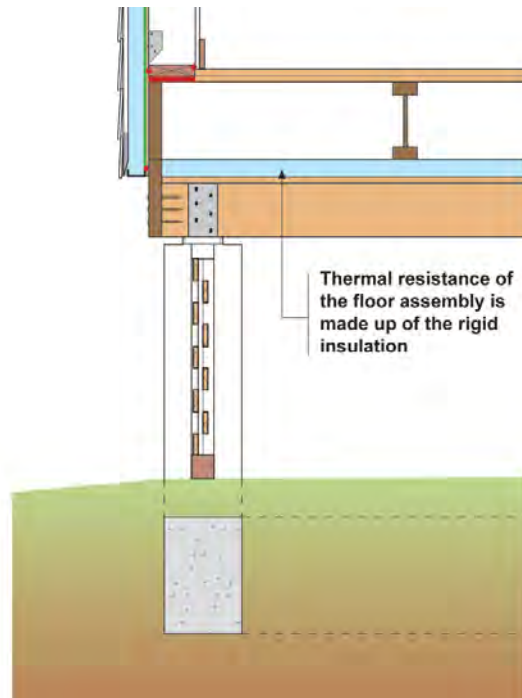

Figure 19: Foundation Thermal Resistance

The wind and lateral loads are transferred from the studs of the wall above to the floor beams of the floor framing. The total uplift forces are then transferred from the floor beams to the pier foundation. The pier foundation will need to be designed based on specific site conditions and elevated above the height of the FEMA Base Flood Elevation (BFE).

At the top of the piers a termite shield will not be required. The solid poured concrete piers allow for a means to inspect for termite activity.

The floor structure is also borate treated to resist rot and decay in the event the material gets wet, and to protect the wood from insects such as termites. In the case of a wetting event, drying of the floor structure can be facilitated by removing a portion of the insulating sheathing from the underside of the structure. This will allow for air flow through the framing which will help with drying of the materials. After the floor structure is dry, the insulating can be reinstalled and taped once more.

### *Windows and Doors*

The window and door installations are designed to be drained systems. A pan flashing is installed below every window and door to direct any water

that may leak through or around the window back out to the exterior. The nailing flanges of the window are sealed with a membrane flashing on the jambs and head of the window. The sill is left open to allow the water to drain out. At the head, the housewrap should be lapped over the membrane flashing to prevent a reverse flashing from being created.

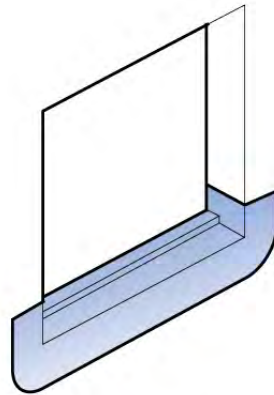

Figure 20: Window Pan Flashing

The continuity of the air barrier is maintained by installing a bead of non-expanding urethane foam between the window frame and the rough opening on all four sides of the window. The foam is installed from the interior prior to the installation of the interior trim. The foam should also be closer to the interior so as not to block drainage of the pan flashing at the sill of the window.

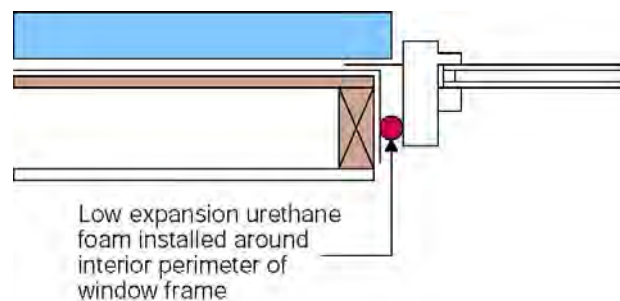

Figure 21: Window Air Barrier Continuity

The thermal resistance of the window is provided by the overall U-value of the window assembly as well as the Solar Heat Gain Coefficient. For hot humid climates, it is generally recommended to minimize both these values. Therefore having a low U-value and a low SHGC will provide for a more

thermally efficient window. The values used for this home were a U-value of 0.33 and an SHGC of 0.30 and are representative of what is available on the market. The value combination will vary from window manufacturer to window manufacturer and even from different windows and sizes by the same manufacturer. Choosing windows close to these performance values is recommended.

#### *Other Penetrations*

There are many other penetrations that are often overlooked in the design of houses. These are from dryer vents, bathroom exhaust fans, exterior electrical outlets, exterior lights, gas lines, etc. These penetrations must be designed into the water management system. Pipe penetrations such as bathroom exhaust vents or dryer vents should be stripped into the drainage plane with membrane flashing. Where the electrical boxes are installed flush with or penetrate through the drainage plane, the box should be stripped in with a membrane flashing to create a flanged seal to the drainage plane. Alternately there are products available on the market that have flanges as part of the electrical box or mechanical vent. With these products the flanges can be then integrated into the drainage plane.

All penetrations through the plane of air tightness should be sealed with caulking or spray foam in order to maintain the continuity of the air barrier.

These penetrations are thermal bridges. In order to minimize the effect of the thermal bridging, the insulation should be installed as close as possible to the penetration to minimize the impact of the disruption of the insulating layer.

#### *Energy Model Results*

The results of the building enclosure upgrades represented a reduction in energy consumption of 19.6% when compared to the energy consumption of the Building America Benchmark house design.

## MECHANICAL SYSTEMS

As with the building enclosure design, working towards energy efficient mechanical systems is also very important in reducing the overall building energy consumption. Creating efficient mechanical systems is not just a matter of using high efficiency units; the overall system strategy, the location of the equipment and ducts, and the design of the distribution systems all

impact the efficiency of the design. This section examines the impacts of efficient mechanical systems through examining the design of the cooling, heating, ventilation, dehumidification, and domestic hot water systems.

Prior to deciding on the specific system design for a house, a calculation should be made as to the maximum heat loss and heat gain of the house to determine how much energy the mechanical system needs to transfer to provide indoor comfort. The Air Conditioning Contractors of America has developed a methodology titled Manual J, which calculates the heating and cooling loads by taking into account the characteristics of the building enclosure. With this information, the system type and size can be determined depending on other constraints.

There are numerous methods for creating and distributing heating and cooling energy within homes, each with their own set of benefits and compromises. The primary decisions about mechanical systems tend to be controlled by available fuels, and by programmatic considerations. In general, there are two types of distribution systems – air based systems and water based systems. While heating can be accomplished with either system, cooling has thus far primarily been provided by air based systems due to the considerations with humidity.

With a tight building enclosure, mechanical ventilation and pollutant source control is also required to ensure that there is reasonable indoor air quality inside the house. A further consideration with the space conditioning system is how it might inter-relate with the mechanical ventilation system. Ventilation air flows are relatively small, and could be accomplished with smaller ducting, but there are certain advantages to coupling the space conditioning and ventilation systems. Exhaust fans located at potential pollutant sources can minimize the need for ventilation, but make-up air must also be considered for the air exhaust fans remove from the house.

In order to ensure good indoor air quality, all combustion appliances are recommended to be sealed combustion and directly vented to the outdoors. These systems are completely decoupled from the interior environment through the use of dedicated outdoor air intake and exhaust ducts connected directly to the unit. Not only are the combustion products decoupled from the interior environment and concerns of back-drafting of the unit removed, but the usual make up air ducts soft connected to an area near the combustion appliance are eliminated. These make up air ducts (required for naturally aspirated units) are a source of uncontrolled air leakage through the building enclosure, and therefore increase utility use. Finally, the sealed combustion appliances tend to be more efficient than the naturally aspirated units.

Forced air systems can integrate the heating and cooling requirements as well as the ventilation requirements into one system, and therefore are often more cost effective than other specialized heating systems. Intermittent central-fan-integrated supply, designed to ASHRAE 62.2 ventilation requirements, with fan cycling control set to operate the central air handler is recommended to provide ventilation air, distribution, and whole-house averaging of air quality and comfort conditions.

Also, an integrated space conditioning and ventilation system is more likely to be serviced, and provides whole house mixing of indoor air. However, if a cooling system is not being installed, then a water based distribution system can be used instead, with smaller ventilation system ducting, and potentially a Heat Recovery Ventilator (HRV) to economize on heat used for ventilation air.

Typically, cooling requires a ducted air conditioning system, and the use of electricity. Depending on the climate, it may also make sense to use electricity and the ducted system to provide heating, in the form of an air source heat pump (ASHP), or ground source heat pump (GSHP). Where there is significant heating required, and natural gas is readily available, the performance of an ASHP or cost of a GSHP may prove to have a higher life-cycle cost than a condensing furnace. In the case where a cooling system is not desired, the duct system can either be downsized, or deleted and a hot water or radiant system can be used instead.

The location of the duct system can have a significant impact on the overall performance of the system, both the utility use and the ability to provide comfort. The energy loss from the ducts for forced air heating and cooling systems can be significant depending on the location of the ducts, and how well the ducts are sealed against air leakage. Though it is conceptually easy to imagine sealed duct systems, it is uncommon to find tight duct systems - duct leakage values of 20% of system flow are common. In many houses, the distribution duct work is located either in a vented crawl space or in a vented attic – effectively outdoors. With the ducts located exterior of the thermal envelope of the home, any leakage and conductive losses from the duct work is lost directly to the outside.

Moving the duct work and air handlers inside the thermal enclosure or extending the thermal enclosure to include areas such as crawl spaces and attic as part of the conditioned space of the house can be used to help prevent this energy loss to the exterior.

In general, the placement of the mechanical equipment will depend on the design of the house. For houses with conditioned crawlspaces and



basements, it is often logical to place the air handler or furnace in those locations. For slab on grade designs or elevated floors, space can become a concern, in which case unvented conditioned and semi-conditioned attics provide for a convenient location for the mechanical equipment and ducts. Otherwise, placement of the equipment and / or ducts in a dropped ceiling or in closets is sometimes necessary. Consideration for space requirements for the mechanical equipment should be made early in the design. The case study house was designed with an unvented conditioned attic, so that all of the duct work and mechanical equipment was able to be located inside the conditioned space of the attic.

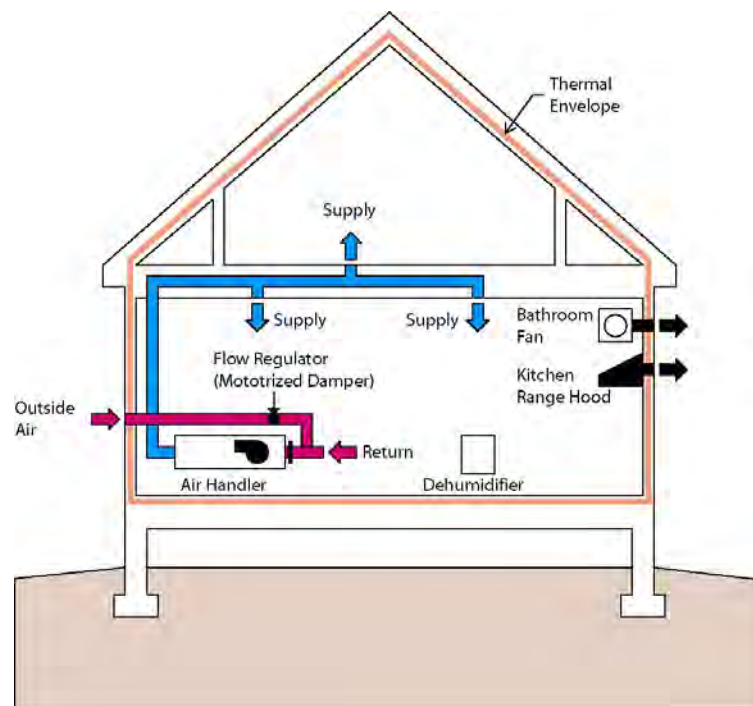

Figure 22: Mechanical Schematic for Hot Humid House

### Cooling System

The cooling system is designed with a 14 SEER air source heat pump unit (similar to a Carrier Infinity 17 or an American Standard Heritage 16), which is a high efficiency unit. Higher efficiency units are available and will further reduce the energy consumption of the house, however the 14 SEER equipment strikes a good balance between efficiency and cost. Since this is a cooling dominated climate, the efficiency of the cooling system is significant in the overall energy consumption of the house, and any upgrades to the system provide good payback terms. In addition, proper sizing (right sizing)

of equipment through Manual J calculations is done in order to prevent over sizing of equipment. Over sized equipment increases cost and creates other performance concerns (such as lack of proper dehumidification through short cycling of the system).

*Heating System*

The heating system is an air source heat pump rated at 8.5 HSPF (again similar to a Carrier Infinity 17 or an American Standard Heritage 16). The seasonal efficiency of air source heat pumps increases as one moves into warmer climate zones, since the outside temperature is higher for a larger portion of the year, and rarely drops to freezing.

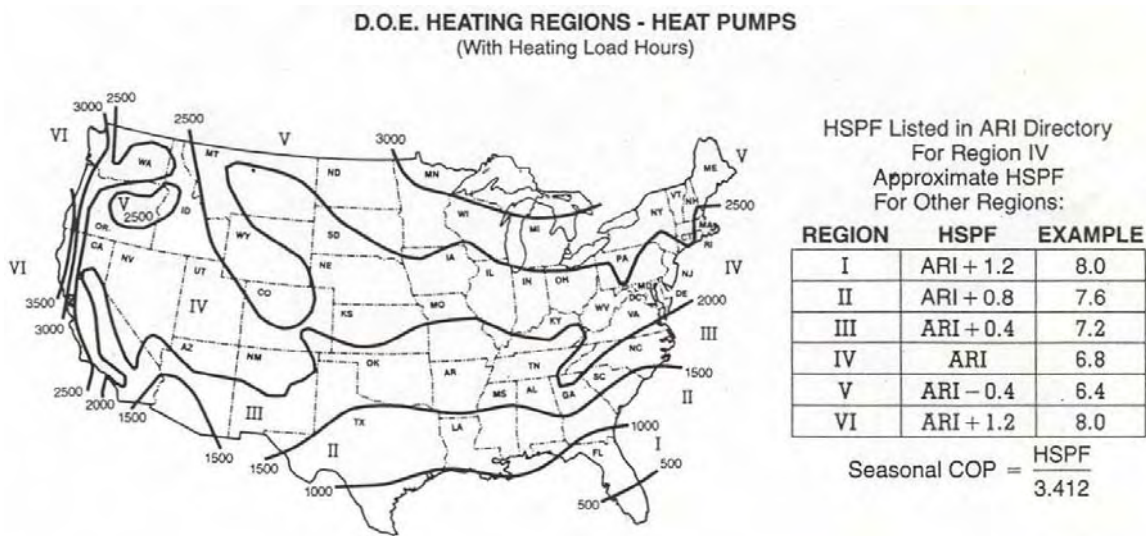

Figure 23: HSPF Adjustment Map

While the standard ARI rated efficiency is 8.5 HSPF, the Air Conditioning and Refrigeration Institute has a climate zone map that shows adjusted efficiencies for different areas of the country. Hot humid climates are in either Zone 1 or Zone 2, which increases the HSPF rating by 0.8 to 1.3, meaning that the actual seasonal efficiency will be between 9.3 to 9.8 HSPF when the unit is used in climates such as Lake Charles.

*Duct Distribution system*

A ductwork distribution system is designed to supply air to rooms in the house with the return being through a central return grill. The Manual J

calculations typically yield the duct sizing and flow requirements to the various rooms to satisfy the loads therein. These flow volumes are used in the duct layout strategy. For the Prototype house, the air handler is located in the living space for ease of access with filter changes and maintenance with the duct work running in the unvented attic. The distribution is from ceiling registers in each of the rooms.

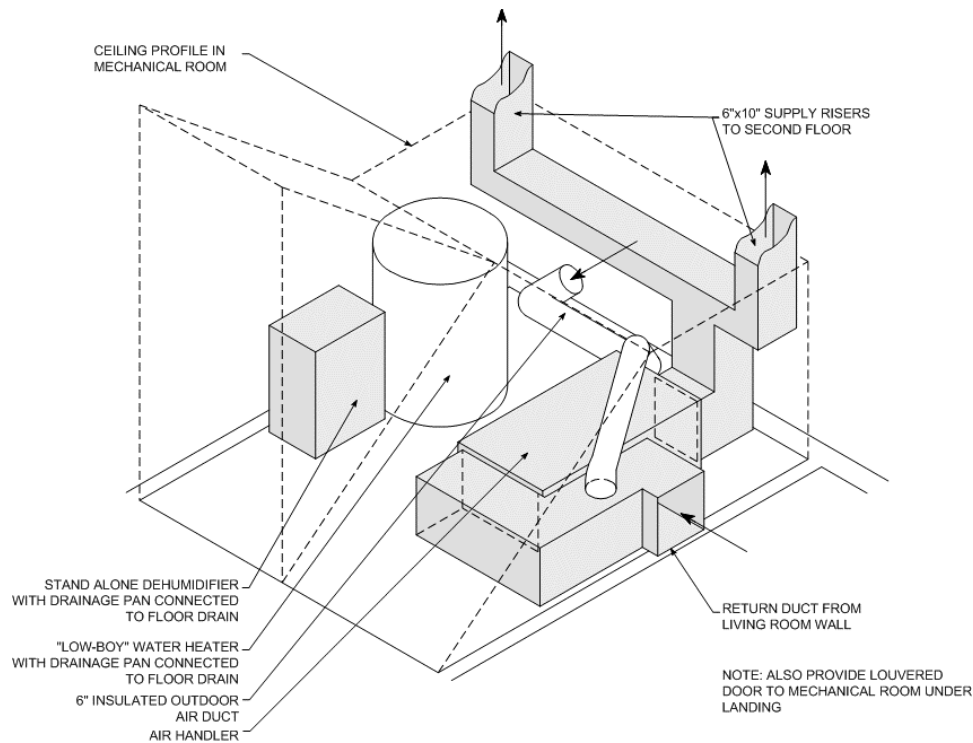

Figure 24: Air Handler Schematic

As with any distribution system, there must be a return path for the energy distributing fluid. In the case of an air-based duct system, there is a central return that is open to the primary living space, with transfer means from bedrooms to the main space. The return path from the bedrooms needs to be able to allow sufficient return flow to prevent room pressurization and allow supply flow. While door undercuts can account for some of the return air path, wall transfer grilles or jump ducts should be installed to provide acceptable means for return air. The flow rates for the Prototype house in the Lake Charles, LA climate are shown in the duct layout strategy shown in the drawing set.

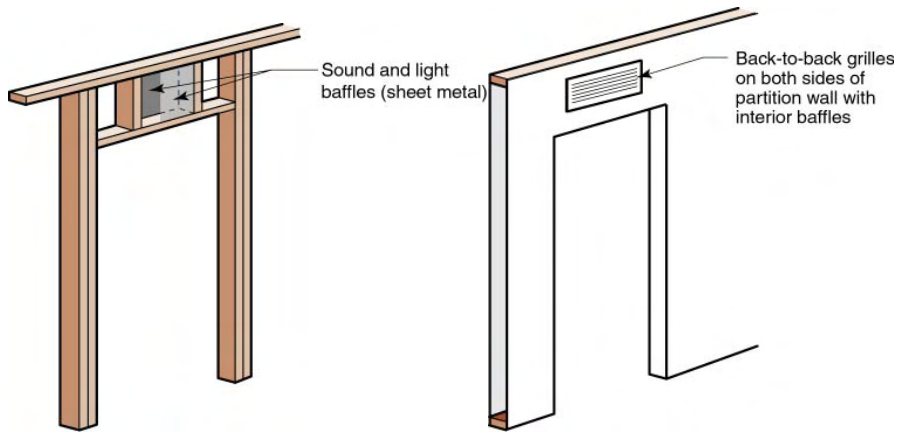

Figure 25: Overdoor transfer grilles

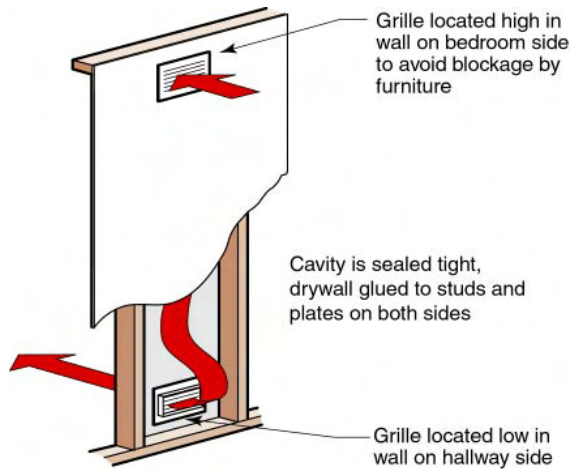

Figure 26: Through wall transfer grilles

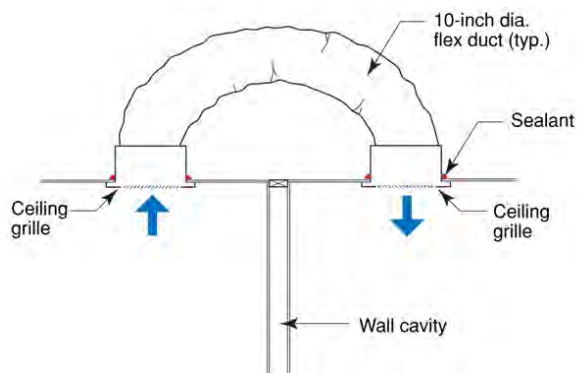

Figure 27: "Jump Duct" over interior partition wall

### *Ventilation*

The ventilation system for this house is designed as a central fan integrated system, which is made up of a 6 inch outdoor air intake duct connected to the return side of the air handler. This duct draws outdoor air in to the air distribution system and distributes it to the various rooms in the house when the air handling unit is running. The intake duct has a motorized damper controlled by a fan cyclor to close the damper to prevent over ventilation of the house during times of significant space conditioning demands. Below is schematic example of the central fan ventilation system with 6" electronically operated damper.

### *Filtration*

It is generally considered good practice to provide for some filtration of the distributed air in the house. It is common to place a filter on the return side of the air handler flow. Standard furnace filters will provide some amount of air cleaning; however in some instances it may be warranted to install a high efficiency 3 to 5 inch filter instead. Even if the high efficiency filter is not added originally, leaving enough room at the return side of the air handler (approximately 12 inches) would allow for the filters to be added to the design at a later date.

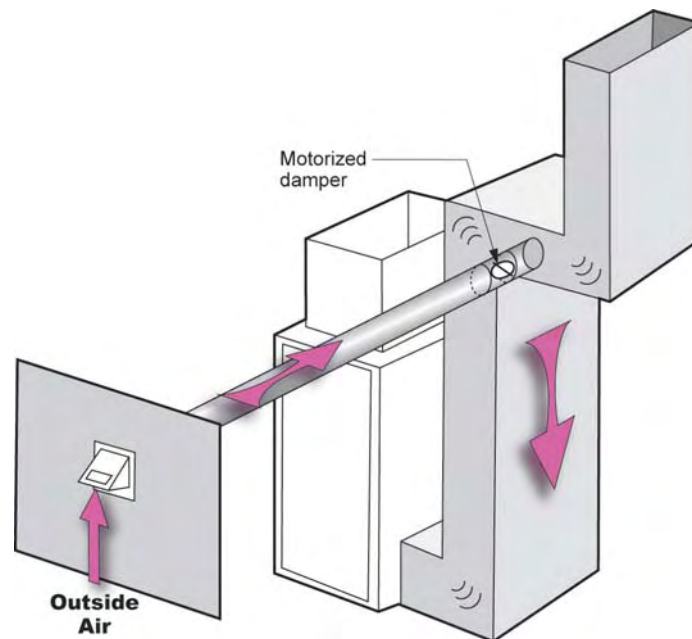

*Figure 28: Outdoor Air Duct Connected to the Return of the Air Handler*

In addition to the central fan integrated ventilation system, provision is also made for point source pollutant control. Exhaust fans located in the bathrooms and kitchen are used to remove the localized odors and higher humidity levels created in these areas.

### *Dehumidification*

In more energy efficient building enclosures the air conditioning loads are reduced, especially the “sensible” (non-humidity) heat gains. Since there is less of a sensible air conditioning load, there also tends to be a reduction in the amount of dehumidification from regular air conditioning operation. Therefore, for hot-humid climates, it is recommended to provide supplemental dehumidification to avoid times of uncomfortably high indoor humidity.

The house is designed with a stand alone dehumidifier located in the base of a mechanical closet behind a louvered door and the air handler located directly above the dehumidifier. This configuration places the dehumidifier directly in the return air path so that the air will be drawn past the dehumidifier during the fan cycling periods. This system has been shown to provide reliable dehumidification while still maintaining affordable installation costs. With this system it is important that the house have proper mixing and redistribution of interior air, therefore central fan cycling is required for distribution of the dehumidified air.

### *Domestic Hot Water*

The Domestic Hot Water system is designed with a high efficiency electric tankless hot water heater with an efficiency rating of 0.98 EF. As well as having lower energy use, an electric tankless hot water heater is much smaller in size, and can be located under a sink or similar area, leaving more storage space elsewhere in the house – valuable with smaller floorplans. Note that an electric tankless water heater draws a significant amount of power when the water is turned on, and the electric panel and utility service size must be considered based on this load.

### *Energy Model Results*

The results of the mechanical systems upgrades represented a reduction in energy consumption of 8.6% when compared to the energy consumption of the Building America Benchmark house design.

## APPLIANCES AND LIGHTING

Efficient appliances and lights are readily available on the market. Many new appliances are Energy Star rated indicating that the appliance consumes less energy than compared to the current federal standards. The amount of energy consumption reduction will vary from appliance to appliance.

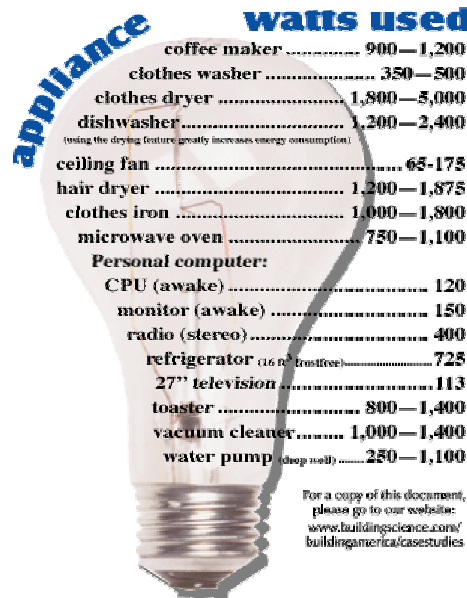

Figure 29: Energy use of Typical Household Appliances

### Compact Fluorescent Lighting

Compact fluorescent lights (CFL) consume on average 70% less energy than regular incandescent lights. In addition they will last around 10 times as long. Even with these benefits, there has been resistance to incorporate CFL's into common use, due to the light quality and the length of time that it took for the bulbs to warm up. Advances in technology have made great improvements in both the quality of light provided by the bulbs and the response time to turning on the switch. However, this does not mean that all the lights are the same. CFLs are available in a range of color temperatures and intensities to suit different lighting requirements in any part of the house.

The ENERGY STAR Advanced Lighting Package recommends that 50% of the lights in high-use rooms and outdoors, and 25% in other rooms be CFLs. However, the energy-use model done for the basic house assumes that all

90% of the lights are compact fluorescents to achieve the maximum energy savings.

While using efficient lights and lighting design can reduce the energy consumption, responsible use of the lights is also factor. The energy model assumes a certain usage amount based on reported lifestyle averages; however actual use will vary dramatically from household to household. Turning off lights in unoccupied rooms or when natural daylight is adequate can be an even more effective energy reduction strategy.

#### *Energy Star Appliance Package*

Clothes washers and dryers, refrigerators, chest freezers, and dishwashers, are significant energy-users in a typical home. ENERGY STAR-rated appliances use 10-50% less energy and water than standard models. The case study house was designed and modeled using Energy Star Appliances.

As with lighting, savings are calculated based on reported lifestyle averages and actual use will vary from household to household. Further reductions in overall energy consumption are possible through the wise use of appliances. Homeowner choices like hanging laundry outside to dry at the right time of year, running washers with full loads only, and turning off and unplugging appliances that are not in use will save energy and lower the operating costs of the house. These lifestyle changes can be encouraged by the builder.

#### *Energy Model Results*

The results of the appliances and lighting upgrades represented a reduction in energy consumption of 10.9% when compared to the energy consumption of the Building America Benchmark house design.



## Section 3: Advanced Technologies for a Hot-Humid Climate

Base energy reductions strategies are for the most part easy to incorporate into residential production building. The technologies are very similar to many traditional construction practices, so training construction crews to adopt slight variations to normal techniques, while not always easy, is at least feasible. Usually a short learning curve is required at the beginning, however, once the techniques are adopted, savings can sometimes be made from less material handling and installation time. These base techniques are also more easily justifiable from a cost analysis point of view.

As we push for more and more energy efficient homes, the limits of some of the base strategies begin to be stressed. Further increases in insulation levels become less practical, achieving increased air tightness becomes more difficult, and efficiencies of equipment begin to reach the limit of current technology.

At this point, additional energy saving strategies should be examined. Some of the more advanced strategies that are currently gaining in popularity are the use of Geothermal Heating and Cooling Systems, Solar Hot Water Systems, and Photovoltaic Technologies.

### ENERGY ANALYSIS OVERVIEW

The case study house was modeled with the following additional energy consumption reduction and energy generation strategies. The strategies were modeled individually to demonstrate the relative impact of each. The final row highlights the total whole house energy consumption reduction if all of the strategies are applied together.

Parametric Run ID	Description of change	Estimated Individual Cost of change	Estimated Cumulative Cost of change	Total Source Energy Savings (H/C/DHW/Lights/Appliances/Plug)					
				over BA Benchmark <sup>1</sup>	Incremental Over Bmrk	Annual energy cost	Item Savings	Simple payback (yr)	Increment payback (yr)
0	Benchmark	n/a	n/a	n/a	n/a	\$1,855	n/a	n/a	n/a
1	0 + Windows as-designed, w/overhangs	n/a	n/a	3.4%	3.4%	\$1,792	n/a	n/a	n/a
2	1 + Air seal	\$200	\$200	10.5%	7.1%	\$1,657	\$198	1	1
3	2 + Ducts in cond. space, 5% leakage	\$200	\$400	17.0%	6.5%	\$1,535	\$122	1	2
4	3 + Ventilation air added (46 CFM)	\$200	\$600	12.7%	-4.3%	\$1,616	(\$81)	3	-2
5	4 + R-10 walls	\$500	\$1,100	13.8%	1.1%	\$1,595	\$21	4	24
6	5 + R-20 roof	\$500	\$1,600	14.2%	0.4%	\$1,586	\$9	6	56
7	6 + R-10 pier foundation	\$500	\$2,100	14.0%	-0.3%	\$1,591	(\$5)	8	-100
8	7 + All windows Low-E2	\$500	\$2,600	19.6%	5.6%	\$1,485	\$106	7	5
9	8 + ASHP: 14 SEER / 8.5 HSPF	\$500	\$3,100	26.4%	6.8%	\$1,356	\$129	6	4
10	9 + 0.98 EF water heater	\$400	\$3,500	28.2%	1.8%	\$1,322	\$34	7	12
11	10 + CFL Lighting Package	\$200	\$3,700	34.8%	6.6%	\$1,221	\$101	6	2
12	11 + ES Appliances	\$300	\$4,000	39.2%	4.3%	\$1,137	\$84	6	4
13	12 + GSHP: 17 EER / 4 COP	\$4,000	\$8,000	42.5%	3.3%	\$1,076	\$61	10	66
14	13 + 40 sf solar hot water system	\$3,000	\$11,000	50.3%	7.9%	\$928	\$148	12	20
15	14 + 2 kW PV system	\$16,000	\$27,000	64.2%	13.9%	\$665	\$263	23	61

### Parametric Annual Loads Study

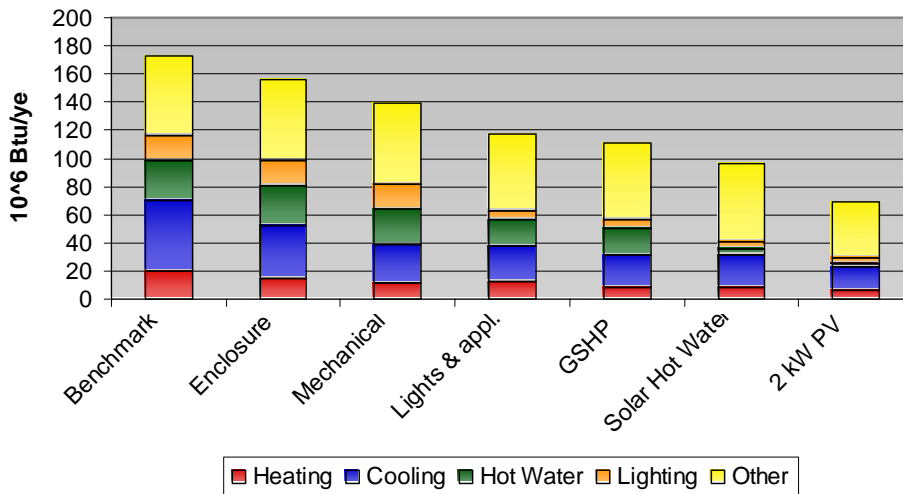

The case study model design achieved a whole house 64.2% energy reduction when all the advanced strategies were employed at the same time compared to the Building America Benchmark.

### Summary of End-Use Site-Energy

End-Use	Annual Site Energy			
	BA Benchmark		Prototype 1	
	kWh	therms	kWh	therms
Space Heating	2811	0	1249	0
Space Cooling	5973	0	2465	0
DHW	2766		1844	
Lighting	1767		588	
Appliances + Plug	5573		5347	
Total Usage	18890	0	11493	0
GSHP	0	0	624	0
SHW site collection	0	0	1485	0
PV Site Collection	0	0	2629	0
Net Energy Use	18890	0	6755	0

### Summary of End-Use Source-Energy and Savings

End-Use	Estimated Annual Source Energy		Source Energy Savings	
	BA Benchmark	Prototype 1	Percent of End-Use	Percent of Total
	106 BTU/yr	106 BTU/yr	Prototype 1 savings	Prototype 1 savings
Space Heating	29	13	56%	8%
Space Cooling	61	25	59%	19%
DHW	28	19	33%	5%
Lighting	18	6	67%	6%
Appliances + Plug	57	55	4%	1%
Total Usage	194	118	39%	39%
GSHP	0	-6		3%
SHW site collection	0	-15		8%
PV Site Collection	0	-27		14%
Net Energy Use	194	69	64%	64%

On the basis of BTU/sf/yr of site energy, the above calculations yield the following:

#### Site Energy Use in BTU/sf for LA: 28605 CDH, 1437 HDD

	Cooling	Heating	Total	Reduction
Benchmark	16.2	7.6	51.2	n/a
Building America	6.7	3.4	31.1	39%
Advanced Technologies	6.1	2.3	25.4	50%

Values in kBtu/sf

## GEOHERMAL HEATING AND COOLING

Geothermal (Ground Source) Heat Pumps work similar to air source heat pumps, except the energy is transferred to the ground instead of to the atmosphere. The higher efficiency that can be achieved from a geothermal heat pump is due to the relatively stable ground temperature during the heating and cooling seasons compared to the variable air temperature of air source heat pumps. While these systems are more efficient than the standard air source heat pumps or air conditioning units, they are also more expensive to install and will run upwards of \$5,000 to \$10,000 for the installed system.

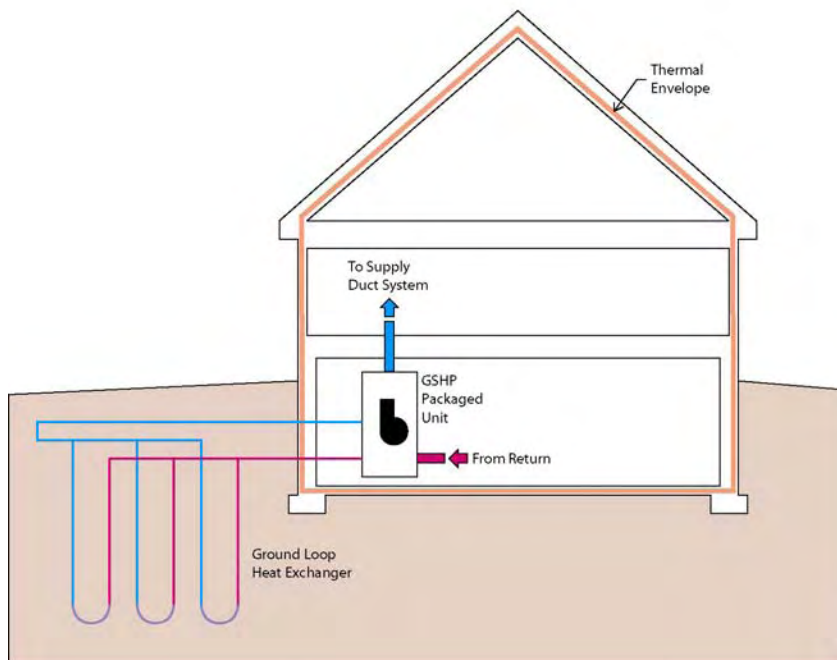

Figure 30: Schematic of a Ground Source Heat Pump

There are three types of geothermal heat pumps, open loop, closed loop, and direct exchange (DX).

### *Open Loop*

In an open loop system, ground water is used as the heat exchange fluid between the ground and the refrigerant loop. Water is drawn out of the ground and circulated through a heat exchange tank containing the refrigerant line. This is not a very common system due to the potential

problems with dirt and debris and general water quality issues that may be encountered from using the natural ground water.

### *Closed Loop*

The closed loop system is the most common system used with geothermal heat pumps. This system uses plastic tubing that is run through either vertical or horizontal wells to transfer the energy to the ground. While similar to an open loop system in that the water is circulated through a heat exchange tank containing the refrigerant line of the heat pump, in this system the water used is not connected to the ground water, but instead run in the plastic tubing. This controls the water quality used in the system, and therefore reduces the potential for problems and maintenance. In heating climates, there is a concern for freezing of the system and therefore some form of anti-freeze will need to be added to the ground loop system.

### *Direct Exchange*

Direct Exchange systems run the refrigerant line directly into the ground, eliminating the heat exchange tank. Because this extra heat transfer step is eliminated from the design, the system should be more efficient. In this system, copper lines are installed into the ground and the refrigerant of the system is circulated through them. Copper, due to its higher thermal conductivity is better able to exchange the heat with the ground when compared to a water circulated system with plastic pipe. While more efficient, there are some considerations that need to be made.

The cost of the system is higher due to the use of copper tubing instead of plastic tubing. Depending on the number and depth of the wells required, this can create a significant cost to the system. The system also has to be site charged with refrigerant, so unlike factory built closed loop GSHP systems, the efficiency is based on the quality of the installation.

### *Design Considerations*

In order for the system to perform properly there must be adequate heat exchange with the ground. The heat exchange is through either vertical or horizontal wells in which the heat exchange fluid is circulated. A general rule of thumb is that a 200 ft ground well is required for each ton of cooling needed. Therefore, for a 3 ton cooling load, three 200 ft wells, would be needed.

From the heat pump side, there are generally two systems currently being used on the market, a packaged system and a split system.

In the packaged system, the compressor and heat exchange tank to the interior of the house and integrated into the air handler. The benefit of this system is that the charging of the refrigerant line is all done in the factory under controlled conditions and it is a fairly simple installation and connection to the ground loops at the site. On the other hand, the compressor is now inside the house, and issues with noise can sometimes occur.

Split systems place the compressor and heat exchange tank on the exterior and the refrigerant line is run to the air handler as in more conventional air source heat pumps. This reduces the noise inside the house; however the refrigerant charge must now be determined on site by a mechanical contractor.

#### *Energy Model Results*

The system used in the energy model is based on the specifications of a ClimateMaster Genesis Packaged Unit. The efficiency of the system is based on the entering water temperature. Therefore the performance of the system used in the energy model was based on the expected entering (returning) water temperature in the both the heating and cooling seasons. This entering water temperature is a function of the average ground temperature and the heat transfer efficiency of the ground. This resulted in a 17 EER for cooling and a 4.0 COP for heating. The resultant incremental whole house energy consumption reduction was 3.3%.

### **SOLAR HOT WATER**

The incorporation of domestic solar hot water system into residential homes has become increasingly popular over the last several years. The basic concept of all solar hot water systems is to use the sun's energy to heat or preheat water, thereby reducing the gas or electric requirements to produce hot water.

In general all solar hot water systems have a solar collector (to collect the sun's energy), and a storage tank (to store the hot water). From this however, the systems can be separated into two different categories, active and passive systems.

Active systems rely on pumps and valves to circulate the water or heat exchange fluid through the solar collector, while passive systems rely on the natural tendency of water to rise when heated, and thereby circulate through the system.

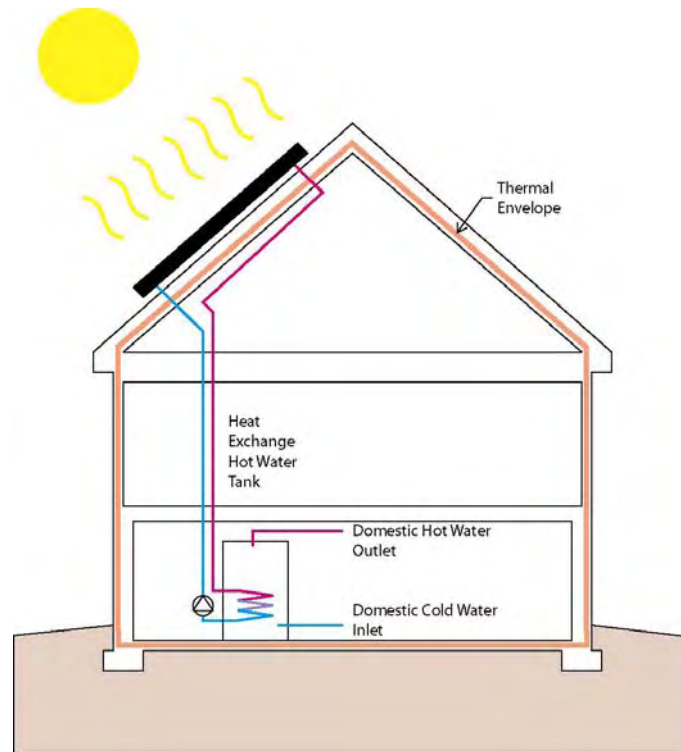

Figure 31: Schematic of a Closed Loop Solar Hot Water System

While active systems are slightly more complicated than passive systems, they can be more flexible in terms of the placement of the components since the location of the storage tank is not dependent on the physics of hot water buoyancy. On the other hand, passive systems, because of the lack of pumps have been argued to be more durable and less prone to problems.

### *Active Systems*

There are three main types of active systems, direct, indirect, and drain back.

With direct systems, the domestic potable water is circulated directly through the solar collector. The pump circulates the water from the storage tank through the solar collector when the temperature of the solar collector is greater than that of the tank. Direct systems are generally not recommended

for climates where the exterior temperature drops below freezing or for areas that have hard or acidic water.

For areas where freeze protection of the system is important, the recommended systems would either be an indirect (closed loop) or drain back system. The indirect (closed loop) systems use a propylene glycol heat exchange fluid in the solar collector. The low freezing temperature of the propylene glycol provides the freeze protection for the system allowing the solar systems to be used in climates prone to longer freezing times. These indirect systems require a check valve to prevent reverse thermosiphoning at night, since the hot water in the tank could convect heat back up to the typically roof mounted solar panels.

The drain back system uses water as the heat exchange fluid. In order to provide for freeze protection, the pump shuts off when the temperature of the collector cools down below that of the tank, and the water in the system “drains back” into storage reservoirs. The panel then fills with air protecting the system from freezing when the pump is turned off.

For both indirect and drain back systems, the solar collection loop is run to a heat exchange coil around a water storage tank. In that way, the systems are decoupled from the potable water delivered to the house.

### *Passive Systems*

There are generally two types of passive systems; thermo-siphon, and integral collector storage.

A thermo-siphon system uses the tendency of water to rise as it is heated. In this system a storage tank is installed at elevation above the collector. As the water is heated, it becomes lighter, and naturally flows up and into the top of the storage tank. The cooler water from bottom of the tank flows down pipes to the bottom of the collector, creating the circulation through the system. As the temperature in the panel drops below the temperature of the storage tank, the circulation through the system stops as well. This prevents the cooler night time temperatures from removing heat from the system.

Thermo-siphon systems can also be designed with a closed loop and heat exchange fluid as well, in areas where freeze protection is required.

In the integral collector storage system, the storage tank is integrated into the solar collector. The cold water supply is connected directly to the collector. As water enters into the panel it is heated up by the sun. However, unlike other systems, the water remains in the panel until there is a call for hot water, and then the water is drawn directly from the panel to fulfill the



demand. Since the hot water is stored in the panel, integrated systems require larger storage tubes in the collector (to increase collection ability) than a normal direct system, which also helps prevent freezing. This is likely the simplest solar hot water system available.

### *Design Considerations*

The solar collectors should be placed on the South side of the building with the optimum tilt for the collector to be set to the azimuth angle for the location of the house. This is to provide the best year round performance of the system.

Due to the potential for high temperature water leaving the solar hot water system, a mixing valve must be installed on all systems to regulate the water temperature delivered to the house, and prevent any concerns about scalding. In addition, it is generally required to install some means of providing back up heat with any solar hot water systems to ensure that hot water demands can be met all year round. The simplest way to provide the back up heat is with a small electric heating coil inside the storage tank. Alternatively, instantaneous water heaters can also be used. If instantaneous water heaters are used for a back up, they must be designed to handle the potentially elevated water temperatures from the solar panel.

Finally, in a hot humid climate zone, the potential for freezing of a collector is relatively small, and therefore the simpler passive ICS style collector can be used. Not only do these units tend to be less expensive, they save interior floor or storage space. An ICS DHW system coupled with a tankless electric hot water heater basically avoids taking any floor space for water heating with solar back-up.

### *Energy Model*

The system used in the energy model is based on an integrated collector storage (ICS) system, similar to CopperSun by Sun Systems. The collector is oriented to the South and the angle was set to the angle of the roof slope in order to approximate the most realistic installation of the panel on the roof. The resultant energy savings was a 7.9% decrease in the overall whole house energy consumption.

## PHOTOVOLTAIC PANELS

Photovoltaic (PV) Panels are used as a means to generate on site energy. The panels are relatively easy to integrate into the design of the house and power system, and are a means to reduce source energy consumption. One of the draw backs are that at this point in time is that the cost of PV panels, while lower than a few years ago, still does not make them cost effective from a payback point of view. The amount of energy generated takes many years to pay off the initial cost of the panels. However, as the use and demand for PV technology increases and further advances in the technology increase the performance of the panels, the costs will continue to drop, making the technology more viable financially.

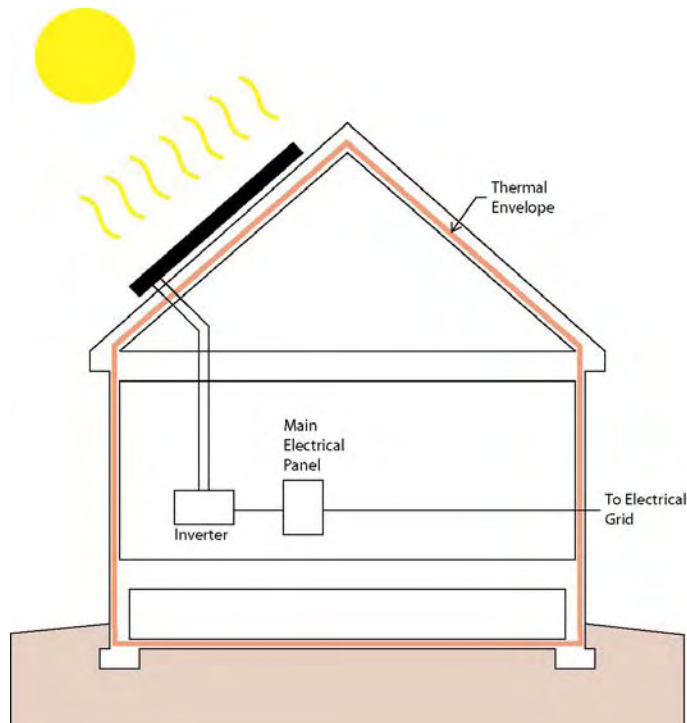

Figure 32: Schematic of a Photovoltaic System Design Considerations

Photovoltaic systems require a collector panel and an inverter in order to produce electricity that is able to be used by the home. Photovoltaic systems are either connected to a battery storage system located on site, or connected into the power grid of the community. For locations where connection to a power grid is not available or impractical, then a battery storage system is

desirable. Battery storage systems however, do require maintenance to ensure that they continue to function adequately. Tying into the local power grid is generally recommended over battery storage when possible, due to the simplicity and costs. This removes the concerns with maintenance of the battery systems.

### *Design Considerations*

There are several aspects of the design of photovoltaic systems that can significantly affect the performance of the system. The location and angle of the collector, internal losses, shading, and temperature should all be considered in the design of the system.

The collector plate should be installed on the South side of the building. Variations within 15 degrees of true South will create relatively little change in the performance of the panels, however, beyond 15 degrees the performance starts to drop off significantly. Also, setting the tilt of the panel to maximize the summer time solar incident angle can increase the energy production of the panel over the course of the year. This can be more difficult than it seems as aesthetic issues often come into play. It may not always be desirable to have the panel in a location of high visibility, and architectural design may limit the options for the collector tilt angle. If PV technologies are going to be incorporated into the design, it should be considered early on in the conceptual design stage, so that systems could be properly integrated into the aesthetic design of the building.

Most systems will experience some internal losses in the system, and only reach approximately 80% to 90% of the rated output of the panel at a maximum. The losses are from dirt, dust, the resistance in the wiring, elevated temperature of the panels, and losses through the inverter. This is common for most systems and should be accounted for in the design of the system.

Even the least bit of shading of the panels can dramatically decrease the performance and close attention to keeping the panels in direct sunlight is very important. This is due to the way the photosensitive cells are linked in the array. Therefore it is very important that the panels are placed in a location such that surrounding elements (such as trees and chimneys) do not cast a shadow over even a portion of the panel. Ideally, the panels would also be cleaned with some regularity of dust, leaves, snow, or any other matter that might get deposited on the solar collector.

The performance of the panels is also affected by temperature. As the temperature of the panel increases, the output of the panels is reduced.

Therefore it is important to try to keep the panels as cool as possible. One strategy is to install the panels slightly off the surface of the roof, to allow for some ventilation behind the panel.

### *Energy Model*

The system used in the energy model is based on a 1.9 kW photovoltaic system (Similar to SunWize Packaged PV system including a Sanyo 190BA3 Solar Module and a Fronius Grid-Tie Inverter). The area of panels required for this system was equivalent to 127 square feet or 10 panels. The amount of site generated energy was able to make up 13.9% of the whole house energy consumption.

## TOWARDS ZERO ENERGY

With the advanced technologies described above, the Hot-Humid Case Study House reaches an impressive 64.2% reduction in energy use when compared to the Building America Benchmark. However, as uncertainty grows around our dependency on fossil fuel-based energy, even greater steps to reduce residential energy use are a priority. In response, the Building America program has established the goal of creating houses that generate as much energy as they use.

A Zero Energy Home (ZEH) is designed to balance energy consumption with site energy collection and conversion so that there is no net energy usage during normal operation of the house. In practical terms this means that over the course of the year, the homeowner's energy consumption from the utility will be zero.

On the other hand, a Zero Cost Home (ZCH) would be a home that had no utility bills, and would need its own battery back-up systems, etc. to avoid utility service fees, and not have to worry about net metering being yearly or monthly, etc.

### *Design Considerations*

The Advanced Technologies section above gives the first steps in making use of the available energy on the site to meet the remaining demand. The geothermal system, the solar hot water system and the photovoltaic panels have been chosen in that order, because they provide the most rational payback period for the energy collected. The final step to reach zero energy is to add significantly to the photovoltaic array.

With the previous sections of this report, the design strategy of looking first for ways to reduce the energy used by the house and then providing power generating capacity to meet the remaining demand. Having maximized the conservation aspects with this house design, reaching for Zero Energy is now left up to sizing the PV collection array based on reasonable assumptions of conservative usage. Therefore, the first and most important steps the design of a ZEH involve decisions that are made by (or for) the homeowner. To start with, the future occupant needs to be made aware of the energy conservation strategy. Experience with utility studies of energy efficient homes has demonstrated that the energy intensity of the homeowner's lifestyle can make a significant difference in the overall utility use, by a factor of 3:1.

The energy reduction plan will include the choice of building site and the orientation of the house on the property (as discussed on page 14), as well as attention to energy-saving practices such as using the thermostat to control indoor conditions (as opposed to windows), using reasonably conservative set points for the heating and cooling systems and turning electrical devices off when not in use (rather than leaving them on the standby setting). These lifestyle-related changes made by, , the homeowner should be considered in concert with the energy load reduction by the building enclosure and mechanical system design described in Section 2 of this package.

For our purposes of sizing a ZEH PV system, an estimation of a 10% reduction in total energy load was used to reduce the size of the PV system required to offset the energy use. With this 10% conservation estimation, a 6500 watt system would be required to reach the ZEH goal, which would require approximately 590 sf of PV panels.

In situations where the cost of the panels is not a consideration, the other constraining factor is the ability to fit the necessary panels on the roof. In the case of the Hot Humid house, a 7200 watt array would be necessary to offset the total load, covering 655 sf of roof area. Again, conservation is much easier than solar collection and conversion.

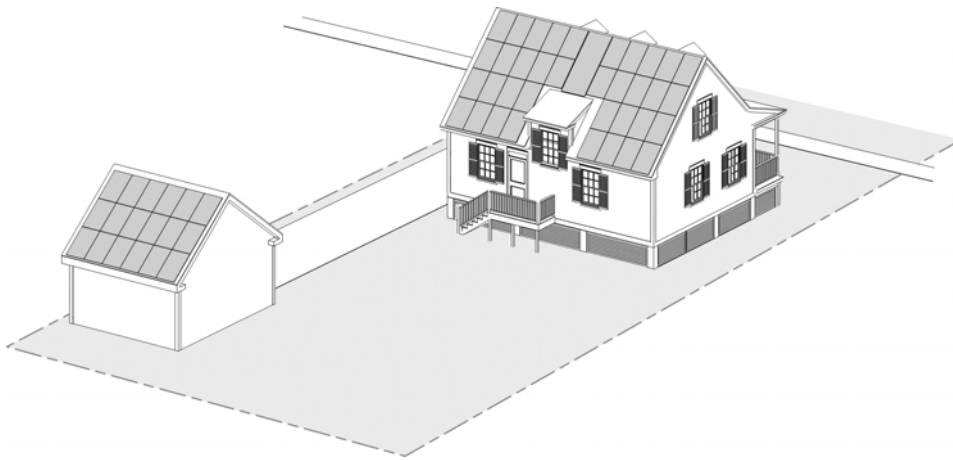

Figure 33: Arrangement of Photovoltaic Array on ZEH

As described in the Photovoltaics section above, the location of the PV array can dramatically affect its performance, especially with regard to partial shading. The drawing above shows how additional panels can be added to the house, while minimizing the risk of shading.

Energy Model Results

Parametric Run ID	Description of change	Estimated Individual Cost of change	Estimated Cumulative Cost of change	Total Source Energy Savings (H/C/DHW/Lights/Appliances/Plug)					
				over BA Benchmark1	Incremental Over Bmrk	Annual energy cost	Item Savings	Simple payback (yr)	Increment payback (yr)
0	Benchmark	n/a	n/a	n/a	n/a	\$1,855	n/a	n/a	n/a
1	0 + Windows as-designed, w/overhangs	n/a	n/a	3.4%	3.4%	\$1,792	n/a	n/a	n/a
2	1 + Air seal	\$200	\$200	10.5%	7.1%	\$1,657	\$198	1	1
3	2 + Ducts in cond. space, 5% leakage	\$200	\$400	17.0%	6.5%	\$1,535	\$122	1	2
4	3 + Ventilation air added (46 CFM)	\$200	\$600	12.7%	-4.3%	\$1,616	(\$81)	3	-2
5	4 + R-10 walls	\$500	\$1,100	13.8%	1.1%	\$1,595	\$21	4	24
6	5 + R-20 roof	\$500	\$1,600	14.2%	0.4%	\$1,586	\$9	6	56
7	6 + R-10 pier foundation	\$500	\$2,100	14.0%	-0.3%	\$1,591	(\$5)	8	-100
8	7 + All windows Low-E2	\$500	\$2,600	19.6%	5.6%	\$1,485	\$106	7	5
9	8 + ASHP: 14 SEER / 8.5 HSPF	\$500	\$3,100	26.4%	6.8%	\$1,356	\$129	6	4
10	9 + 0.98 EF water heater	\$400	\$3,500	28.2%	1.8%	\$1,322	\$34	7	12
11	10 + CFL Lighting Package	\$200	\$3,700	34.8%	6.6%	\$1,221	\$101	6	2
12	11 + ES Appliances	\$300	\$4,000	39.2%	4.3%	\$1,137	\$84	6	4
13	12 + GSHP: 17 EER / 4 COP	\$4,000	\$8,000	42.5%	3.3%	\$1,076	\$61	10	66
14	13 + 40 sf solar hot water system	\$3,000	\$11,000	50.3%	7.9%	\$928	\$148	12	20
15	14 + 2 kW PV system	\$16,000	\$27,000	64.2%	13.9%	\$665	\$263	23	61
16	15 + ZEH: Add 5.2 kW PV	\$40,000	\$67,000	99.8%	35.5%	\$0	\$665	36	60

\*Note that the energy cost of \$0 doesn't include monthly fees, etc.

### Summary of End-Use Site-Energy

End-Use	Annual Site Energy			
	BA Benchmark		Prototype 1	
	kWh	therms	kWh	therms
Space Heating	2811	0	1249	0
Space Cooling	5973	0	2465	0
DHW	2766		1844	
Lighting	1767		588	
Appliances + Plug	5573		5347	
Total Usage	18890	0	11493	0
GSHP	0	0	624	0
SHW site collection	0	0	1485	0
<i>PV Site Collection</i>	0	0	9342	0
<i>Net Energy Use</i>	18890	0	42	0

### Summary of End-Use Source-Energy and Savings

End-Use	Estimated Annual Source Energy		Source Energy Savings	
	BA Benchmark	Prototype 1	Percent of End-Use	Percent of Total
	106 BTU/yr	106 BTU/yr	Prototype 1 savings	Prototype 1 savings
Space Heating	29	13	56%	8%
Space Cooling	61	25	59%	19%
DHW	28	19	33%	5%
Lighting	18	6	67%	6%
Appliances + Plug	57	55	4%	1%
Total Usage	194	118	39%	39%
GSHP	0	-6		3%
SHW site collection	0	-15		8%
PV Site Collection	0	-96		49%
<i>Net Energy Use</i>	194	0	100%	100%

## IN CONCLUSION

A house must be able to provide satisfactory service in its particular location on a number of different fronts, including occupant comfort, functional program needs, moisture and thermal performance, and durability.

In the preceding document we've shown you the results of a design process that takes into consideration aspects of building science as they relate to a Hot-Humid climate, as well as energy conservation measures that can be implemented today. We've presented strategies that can bring further reductions in energy use through the use of higher efficiency mechanical and solar collection equipment. And finally, we have discussed the strategy and sizing changes necessary to reach a Zero Energy Home.

With the plans available in this document, you can decide on the level of energy conservation versus cost that makes sense to you, and proceed with building a high-performance home appropriate for a Hot Humid Climate.

1: Introduction

2: The Basic House

3: Advanced Technologies



## Resources for Builders in a Hot-Humid Climate

### GENERAL RESOURCES

*Builder's Guide to Hot-Humid Climates* ([www.buildingsciencepress.com](http://www.buildingsciencepress.com))

*EEBA Water Management Guide* ([www.eeba.org/bookstore](http://www.eeba.org/bookstore))

Building America Performance Targets

[www.buildingscience.com/buildingamerica/targets.htm](http://www.buildingscience.com/buildingamerica/targets.htm)

International Energy Conservation Code (IECC) Climate Zones

[www.energycodes.gov/implement/pdfs/color\\_map\\_climate\\_zones\\_Mar03.pdf](http://www.energycodes.gov/implement/pdfs/color_map_climate_zones_Mar03.pdf)

DOE Climate Zones by County

[www.eere.energy.gov/buildings/building\\_america](http://www.eere.energy.gov/buildings/building_america)

Houses that Work II

[www.buildingscience.com/housethatwork](http://www.buildingscience.com/housethatwork)

Building Materials Property Table

[www.buildingscience.com/housethatwork/buildingmaterials.htm](http://www.buildingscience.com/housethatwork/buildingmaterials.htm)

Building Science Glossary

[www.buildingscience.com/resources/glossary.htm](http://www.buildingscience.com/resources/glossary.htm)

### OTHER HOT-HUMID HOUSE DESIGN CASE STUDIES

Hot-Humid Climate construction details:

[www.buildingscience.com/housethatwork/hothumid/houston.htm](http://www.buildingscience.com/housethatwork/hothumid/houston.htm)

[www.buildingscience.com/housethatwork/hothumid/maitland.htm](http://www.buildingscience.com/housethatwork/hothumid/maitland.htm)

[www.buildingscience.com/housethatwork/hothumid/orlando.htm](http://www.buildingscience.com/housethatwork/hothumid/orlando.htm)

[www.buildingscience.com/housethatwork/hothumid/montgomery.htm](http://www.buildingscience.com/housethatwork/hothumid/montgomery.htm)

## SITE: DRAINAGE, PEST CONTROL, AND LANDSCAPING

Pest Control

[www.uky.edu/Ag/Entomology/entfacts/efstruc.htm](http://www.uky.edu/Ag/Entomology/entfacts/efstruc.htm)

## FOUNDATION: MOISTURE CONTROL AND ENERGY PERFORMANCE

Radon resistant construction practices (EPA radon control web site):

[www.epa.gov/iaq/radon/construc.html](http://www.epa.gov/iaq/radon/construc.html)

Borate-treated rigid insulation:

[www.buildingscience.com/buildingamerica/casestudies/fairburn/default.htm](http://www.buildingscience.com/buildingamerica/casestudies/fairburn/default.htm)

## BUILDING ENCLOSURE: MOISTURE CONTROL AND ENERGY PERFORMANCE

Design using advanced framing methods:

[www.buildingscience.com/housethatwork/advancedframing/default.htm](http://www.buildingscience.com/housethatwork/advancedframing/default.htm)

Air sealing details:

[www.buildingscience.com/housethatwork/airsealing/default.htm](http://www.buildingscience.com/housethatwork/airsealing/default.htm)

“Insulations, Sheathings, and Vapor Diffusion Retarders”

[www.buildingscience.com/resources](http://www.buildingscience.com/resources)

Solar driven moisture in wall assemblies:

[www.buildingscience.com/resources/walls/solar\\_driven\\_moisture\\_brick.htm](http://www.buildingscience.com/resources/walls/solar_driven_moisture_brick.htm)

Solar driven moisture in roof assemblies:

[www.buildingscience.com/resources/roofs/unvented\\_roof.pdf](http://www.buildingscience.com/resources/roofs/unvented_roof.pdf)

Window flashing:

*EEBA Water Management Guide* ([www.eeba.org/bookstore](http://www.eeba.org/bookstore))

ENERGY STAR® Reflective Roof Product List

[www.energystar.gov/ia/products/prod\\_lists/roof\\_prods\\_prod\\_list.xls](http://www.energystar.gov/ia/products/prod_lists/roof_prods_prod_list.xls)

## MECHANICALS/ELECTRICAL/PLUMBING

HVAC system sizing (ACCA Manual J and Manual D):

[www.buildingscience.com/resources/mechanical/hvac/509a3\\_cooling\\_system\\_sizing\\_pro.pdf](http://www.buildingscience.com/resources/mechanical/hvac/509a3_cooling_system_sizing_pro.pdf)

Mechanical ventilation integrated with HVAC system design:

[www.buildingscience.com/resources/mechanical/hvac/advanced\\_space\\_conditioning.pdf](http://www.buildingscience.com/resources/mechanical/hvac/advanced_space_conditioning.pdf)

Transfer Grilles:

[www.buildingscience.com/resources/mechanical/hvac/transfer\\_grille\\_detail.pdf](http://www.buildingscience.com/resources/mechanical/hvac/transfer_grille_detail.pdf)

[www.buildingscience.com/resources/mechanical/hvac/transfer\\_grills.htm](http://www.buildingscience.com/resources/mechanical/hvac/transfer_grills.htm)

Indoor humidity:

[www.buildingscience.com/resources/moisture/relative\\_humidity\\_0402.pdf](http://www.buildingscience.com/resources/moisture/relative_humidity_0402.pdf)

Whole house dehumidification system:

[www.buildingscience.com/resources/mechanical/hvac/residential\\_dehumidification.pdf](http://www.buildingscience.com/resources/mechanical/hvac/residential_dehumidification.pdf)

Air conditioning best practices:

[www.buildingscience.com/resources/mechanical/air\\_conditioning\\_equipment\\_efficiency.pdf](http://www.buildingscience.com/resources/mechanical/air_conditioning_equipment_efficiency.pdf)

High-energy efficiency major appliances:

[www.eere.energy.gov/EE/buildings\\_appliances.html](http://www.eere.energy.gov/EE/buildings_appliances.html)

## COMMISSIONING

SNAPSHOT (Short Non-Destructive Approach to Provide Significant House Operation Thresholds) form:

[www.buildingscience.com/buildingamerica/snapshot\\_form.pdf](http://www.buildingscience.com/buildingamerica/snapshot_form.pdf)

[www.buildingscience.com/buildingamerica/snapshot\\_instructions.pdf](http://www.buildingscience.com/buildingamerica/snapshot_instructions.pdf)

## ADVANCED TECHNOLOGIES

Primer on Photovoltaics

[www.buildingscience.com/resources/misc/BSC\\_PV\\_Primer.pdf](http://www.buildingscience.com/resources/misc/BSC_PV_Primer.pdf)

1: Introduction

2. The Basic House

3. Advanced Technologies

## Appendix: ACCA Manual J Calculations

1: Introduction

2: The Basic House

3: Advanced Technologies

1: Introduction

2. The Basic House

3. Advanced Technologies



## Project Report

### General Project Information

Project Title: Cajun House  
 Designed By: Philip Kerrigan  
 Project Date: 5/06  
 Client Name: Habitat For Humanity  
 Company Name: Building Science Corporation  
 Company Representative: Philip Kerrigan Jr  
 Company Address: 70 Main Street  
 Company City: Westford, MA 01886  
 Company Phone: (978) 589-5100  
 Company Fax: (978) 589-5103  
 Company E-Mail Address: aaron@buildingscience.com  
 Company Website: www.buildingscience.com

### Design Data

Reference City: Lake Charles, Louisiana  
 Daily Temperature Range: Medium  
 Latitude: 30 Degrees  
 Elevation: 13 ft.  
 Altitude Factor: 1.000  
 Elevation Sensible Adj. Factor: 1.000  
 Elevation Total Adj. Factor: 1.000  
 Elevation Heating Adj. Factor: 1.000  
 Elevation Heating Adj. Factor: 1.000

	<u>Outdoor Dry Bulb</u>	<u>Outdoor Wet Bulb</u>	<u>Indoor Rel.Hum</u>	<u>Indoor Dry Bulb</u>	<u>Grains Difference</u>
Winter:	31	0	30	72	15
Summer:	93	77	50	75	50

### Check Figures

Total Building Supply CFM:	620	CFM Per Square ft.:	0.380
Square ft. of Room Area:	1,633	Square ft. Per Ton:	1,010
Volume (ft³) of Cond. Space:	12,811	Air Turnover Rate (per hour):	2.9

### Building Loads

Total Heating Required With Outside Air:	17,806 Btuh	17.806 MBH
Total Sensible Gain:	14,552 Btuh	83 %
Total Latent Gain:	3,085 Btuh	17 %
Total Cooling Required With Outside Air:	17,637 Btuh	1.47 Tons (Based On Sensible + Latent)
		1.62 Tons (Based On 75% Sensible Capacity)

### Notes

Calculations are based on 8th edition of ACCA Manual J.  
 All computed results are estimates as building use and weather may vary.  
 Be sure to select a unit that meets both sensible and latent loads.



### Total Building Summary Loads

Component Description	Area Quan	Sen Loss	Lat Gain	Sen Gain	Total Gain
LoE2 Spectrally Sel: Glazing-	212.7	3,052	0	5,911	5,911
11P: Door-Polyurethane Core	12.6	150	0	106	106
R-10 XPS: Wall-Frame, , 2x4 wall no cavity insulation 2" r-xps sheathing	1676.3	6,874	0	2,631	2,631
17A-20: Roof/Ceiling-On exposed beams, Dark or Bold- Color Asphalt Shingle, Dark Metal, Dark Membrane, Dark Tar and Gravel, 1.5" wood plus R-20 insulation	1118	1,969	0	1,586	1,586
20P-10: Floor-Over open crawl space or garage, Passive, R-10 board insulation, any cover	816	2,711	0	859	859
Subtotals for structure:		14,756	0	11,093	11,093
People:	4		800	920	1,720
Equipment:			0	1,200	1,200
Lighting:	0			0	0
Ductwork:		0	0	0	0
Infiltration: Winter CFM: 21, Summer CFM: 21		963	722	423	1,145
Ventilation: Winter CFM: 46, Summer CFM: 46		2,087	1,563	916	2,479
Total Building Load Totals:		17,806	3,085	14,552	17,637

#### Check Figures

Total Building Supply CFM:	620	CFM Per Square ft.:	0.380
Square ft. of Room Area:	1,633	Square ft. Per Ton:	1,010
Volume (ft <sup>3</sup> ) of Cond. Space:	12,811	Air Turnover Rate (per hour):	2.9

#### Building Loads

Total Heating Required With Outside Air:	17,806 Btuh	17.806 MBH
Total Sensible Gain:	14,552 Btuh	83 %
Total Latent Gain:	3,085 Btuh	17 %
Total Cooling Required With Outside Air:	17,637 Btuh	1.47 Tons (Based On Sensible + Latent)
		1.62 Tons (Based On 75% Sensible Capacity)

#### Notes

Calculations are based on 8th edition of ACCA Manual J.  
 All computed results are estimates as building use and weather may vary.  
 Be sure to select a unit that meets both sensible and latent loads.





### System 1 Room Load Summary

Room No	Room Name	Area SF	Htg Sens Btuh	Htg Nom CFM	Run Duct Size	Run Duct Vel	Clg Sens Btuh	Clg Lat Btuh	Clg Nom CFM	Air Sys CFM
---Zone 1---										
1	Living	197	2,437	32	1-6	403	1,739	107	79	79
2	Dining	126	1,819	24	1-6	427	1,845	486	84	84
3	Kitchen	97	1,041	14	1-6	413	1,785	39	81	81
4	Back Hall	35	308	4	1-4	58	111	16	5	5
5	Mstr Bath	60	1,055	14	1-4	490	940	58	43	43
6	Master Bedroom	198	2,264	29	1-6	464	2,002	507	91	91
7	Downstair Hall	103	665	9	1-4	122	235	27	11	11
8	Bedroom 2	324	2,271	30	1-6	423	1,828	103	83	83
9	Bedroom 3	323	2,269	29	1-6	423	1,826	103	83	83
10	Bath 2	70	756	10	1-4	219	420	46	19	19
11	Stair	100	834	11	1-4	472	905	30	41	41
Ventilation			2,087				916	1,563		
System 1 total		1,633	17,806	204			14,552	3,085	620	620

System 1 Main Trunk Size: 10x13 in.  
 Velocity: 735 ft./min  
 Loss per 100 ft.: 0.092 in.wg

### Cooling System Summary

	Cooling Tons	Sensible/Latent Split	Sensible Btuh	Latent Btuh	Total Btuh
Net Required:	1.47	83% / 17%	14,552	3,085	17,637
Recommended:	1.62	75% / 25%	14,552	4,851	19,403

### Equipment Data

	Heating System	Cooling System
Type:		
Model:		
Brand:		
Efficiency:		
Sound:		
Capacity:		
Sensible Capacity:	n/a	0 Btuh
Latent Capacity:	n/a	0 Btuh





The U.S. Department of Energy's Building America Program is reengineering the American home for energy efficiency and affordability. Building America works with the residential building industry to develop and implement innovative building processes and technologies—innovations that save builders and homeowners millions of dollars in construction and energy costs. This industry-led, cost-shared partnership program uses a systems engineering approach to reduce energy use, construction time, and construction waste.

The research conducted by Building America teams improves the quality and performance of today's homes and provides valuable information for homes of the future. By supporting the development of innovative building methods and technologies that achieve significant energy and cost savings, the Building America Program is helping to shape the future of American Homes.

FOR MORE INFORMATION VISIT OUR WEB SITE AT:

[www.buildingamerica.gov](http://www.buildingamerica.gov)

