

Thermal bridges, shading and other thermal complications

Dr John F Straube, P.Eng.
Building Science Corporation
&
University of Waterloo
Department of Civil Engineering
& School of Architecture
Waterloo, Ontario, Canada



www.buildingscience.com



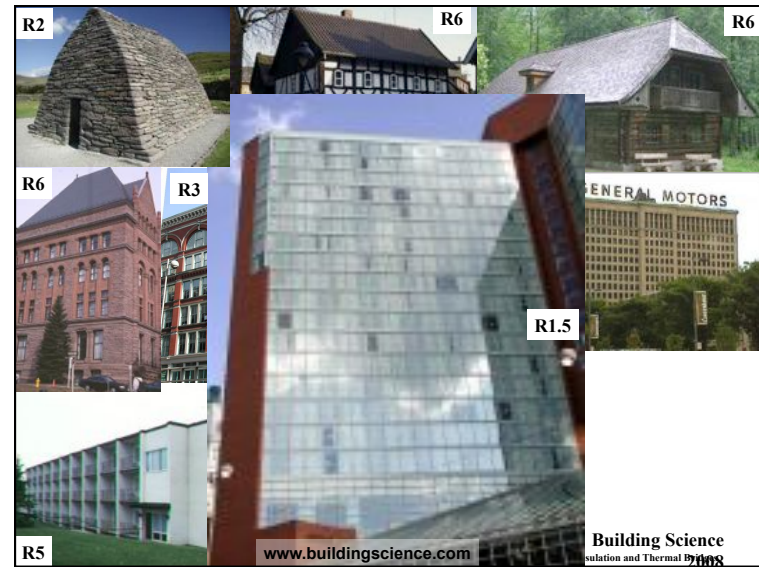
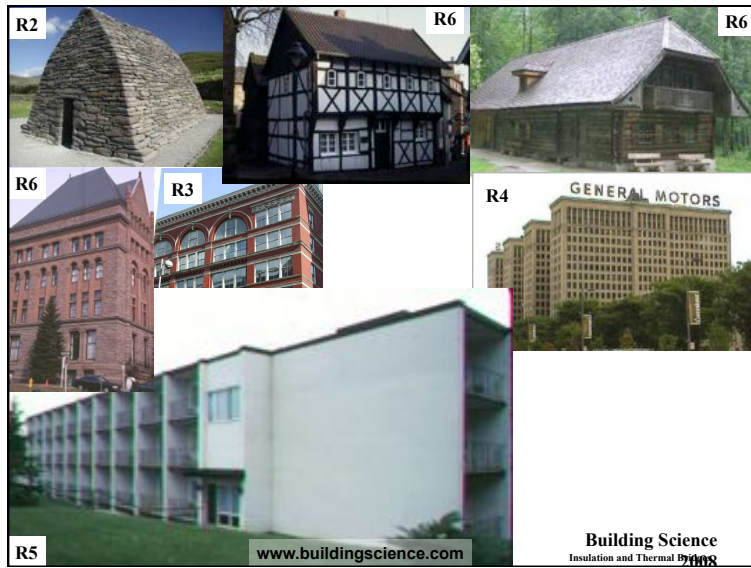
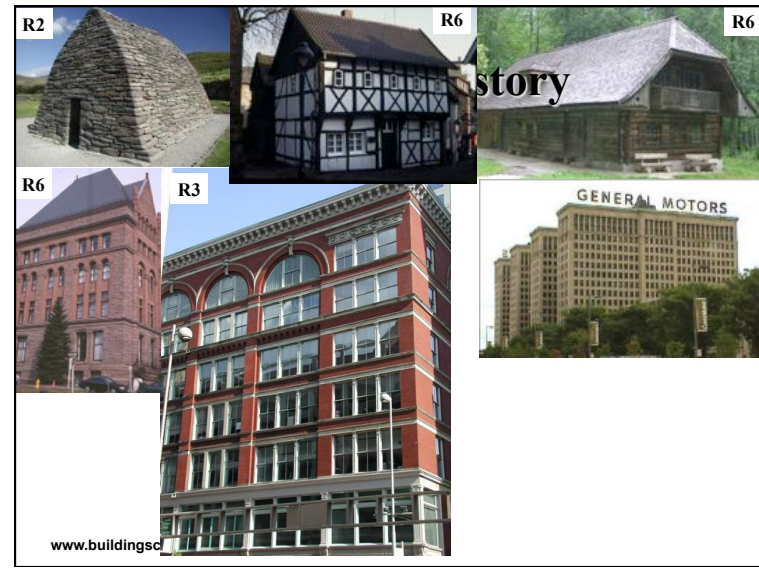
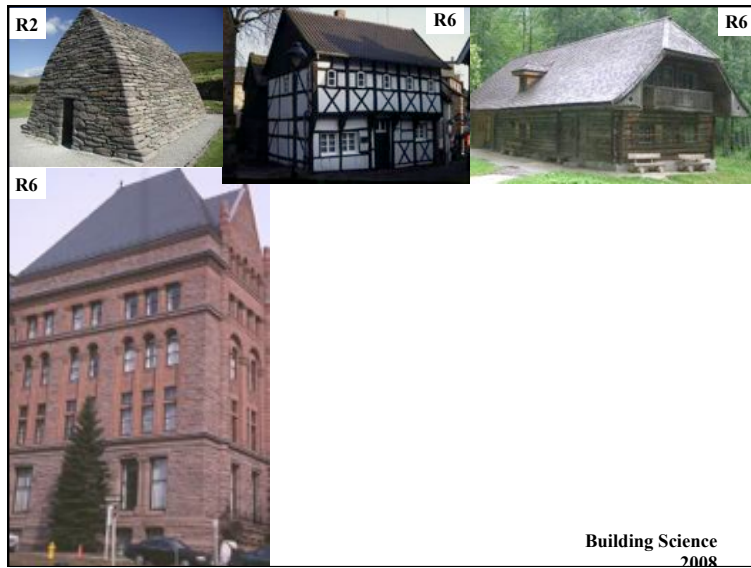



Presentation

- **Heat Flow**
 - Basics: One D
 - Two D
 - Three D
- **Walls + Windows**
- **Practical Detailing Applications**
- **Window Solar Gain Control**

www.buildingscience.com

10

Heat Flow Basics

www.buildingscience.com

Why control heat flow?

- **Occupant Comfort**
- **Energy Savings**
- **Control surface and interstitial condensation**
- **Save duct and heating plant costs (Capital)**
- **Meet Codes and specs**

www.buildingscience.com

12

Heat & Temperature

- **Heat**
 - A form of energy (like Light & Sound)
- **Temperature**
 - A measure of the amount of thermal energy
- **Heat Flow**
 - From more to less energy

www.buildingscience.com

13

What about the old metric?

R-Value

- **Property of a material**
- **Measurement of resistance to heat flow**
- **Proposed in 1945 by Everett Schuman, Penn State's Housing Research Institute**

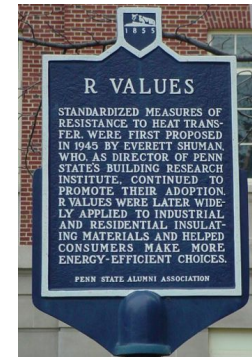

www.buildingscience.com

Benefits of R-Value

- **Widely Accepted**
 - FTC Regulation
- **Simple to Measure**
 - Commercially available test machines
- **Easy to Communicate**
 - **ONE Number at standard temperature**
 - **Lumps all 3 modes of heat transfer into an *effective* conductivity**
 - Conduction
 - Convection
 - Radiation

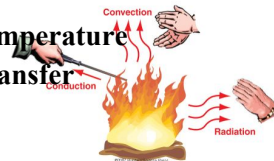

www.buildingscience.com

Heat Flow

- **Always moves from more to less**
- **Rate of flow depends on**
 - Temperature Difference
 - Material Properties
 - Type & Mode of Heat Flow

www.buildingscience.com

16

Categories of Heat Flow

- **Mode of Heat Flow**
 - Conduction
 - Convection
 - Radiation
- **Type of Heat flow**
 - steady-state or dynamic
 - one-, two- or three-dimensional
 - We usually use 1-D static!

www.buildingscience.com

17

Conduction

- Heat Flow by direct contact
- Vibrating molecules
- Most important for solids

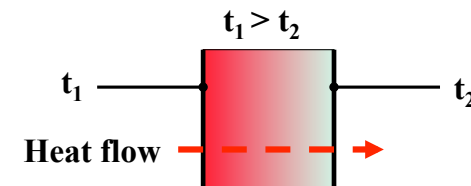

www.buildingscience.com

18

Convection

- Heat Flow by bulk movement of molecules
- Most important for liquids and gases
- E.g. air flow (forced air furnace)

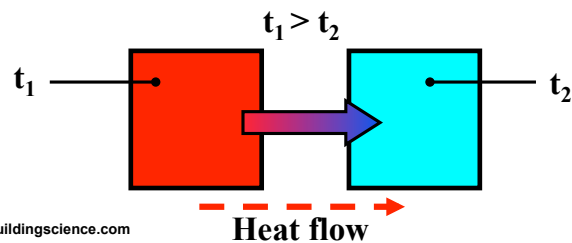

www.buildingscience.com

19

Convection

- Also heat flow from solid to liquid or gas
- Critical for surface heat transfer (e.g. convectors, hot + cold surfaces)

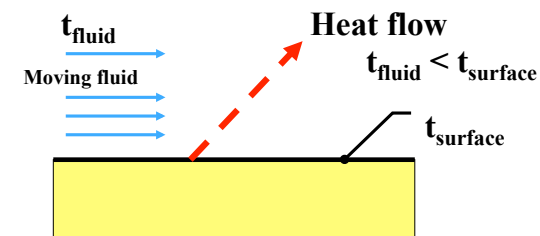

www.buildingscience.com

20

Radiation

- Heat flow by electromagnetic waves
- Heat radiates from *all* materials, e.g. campfire
- Passes through gases and vacuum (NOT Solid)

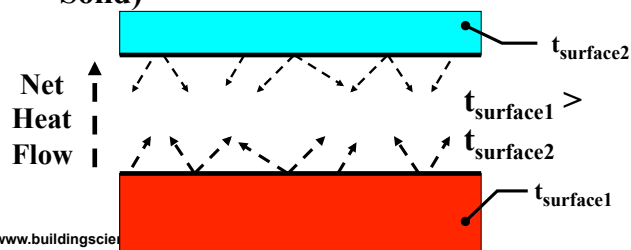

www.buildingscience.com

21

Radiation

- Important for surfaces, air spaces, voids
- Foil faced insulation, radiant barriers only work when facing an air space
- Radiation within *pores* important for high void insulation (e.g., glass batt)
- e.g. Thermos bottle
- Critical for low-E windows

www.buildingscience.com

22

Calculating Heat Flow

- **Conduction**
 - $q = k/l A(T_1 - T_2) = C A \Delta T = A \Delta T / R$
 - k = conductivity f(T, MC, density, time?)
 - C = k/l conductance
 - R = resistance = $1/C$
- **Convection**
 - E.g. $q = 1.42 (\Delta T/L)^{0.25} A(\Delta T)$
 - Typical $C_{equiv} = 2$ to $20 \text{ W m}^2\text{K}$
- **Radiation**
 - E.g. $q = F_E A_1 \sigma (T_1^4 - T_2^4)$

www.buildingscience.com

23

Calculating Heat Flow

$$Q = CA(\Delta T)$$

$$C = k/l \quad R = 1 / C$$

- **Where**
 - Q = heat flow rate (Btu/hr, W = J/s)
 - A = area heat is flowing through (ft^2 , m^2)
 - ΔT = temperature difference ($^\circ\text{F}$, $^\circ\text{C}$)
 - C = conductance of the layer ($\text{W}/\text{m}^2\text{K}$)
 - U = conductance of an assembly ($\text{Btu}/\text{hr}/\text{ft}^2/^\circ\text{F}$)
 - k = thermal conductivity (Btu/ft/F, W/mk)
 - l = length of flow path (ft, m)

www.buildingscience.com

24

Example

$$0.144 \text{ Btu}\cdot\text{in} / (\text{hr}\cdot\text{ft}^2\cdot^\circ\text{F}) = \text{W} / \text{m}\cdot\text{K}$$
$$6.944 \text{ W/mk} = \text{Btu}\cdot\text{in} / (\text{hr}\cdot\text{ft}^2\cdot^\circ\text{F})$$

- **Insulation**
 - $k = 0.20 \text{ Btu}\cdot\text{in} / (\text{hr}\cdot\text{ft}^2\cdot^\circ\text{F}) (= 0.029 \text{ W/mK})$
 - $R5 / \text{inch} (= 1 / 0.20)$
- **3 inch thick layer**
- $T_{\text{in}} = 70 \text{ }^\circ\text{F}$
- $T_{\text{out}} = 20 \text{ }^\circ\text{F}$
- $Q = k/L (T_{\text{in}} - T_{\text{out}}) = 0.20/3 (70 - 20) = 0.0667 * 50$
 $= 3.33 \text{ Btu/hr/sf}$
- $Q = \Delta T/R = 50 / 15 = 3.33$

www.buildingscience.com

Measuring Thermal Conductivity

- **A material property**
- **Measure heat flow through a unit thickness and unit area of material under a unit temperature difference**
- **Heat flow Btu/h, J/s**
- **Area sq ft, sq m**
- **Thickness ft, m**

ASTM C518
ASTM C166

www.buildingscience.com



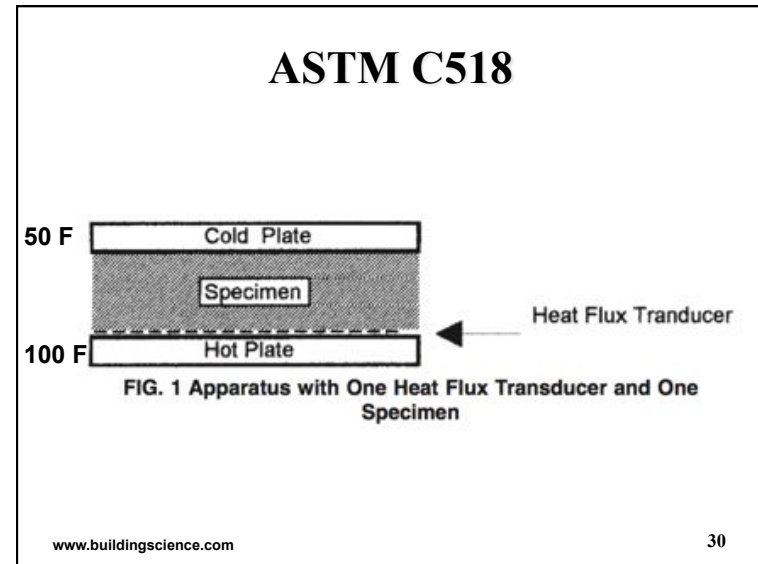

Thermal Performance Metrics

- **Conduction Only:**
 - Thermal Conductivity k
 - Conductance $C = k / \text{thickness}$
 - Resistance = thickness / conductivity
- “Effective” conductivity includes other modes
 - ASTM “R-value” includes all three modes
 - ASTM picks “standard” conditions

Effective Conductance

- A **layer** property
 - Expresses how easily heat can flow through a layer of the material
- $$C = k/l = 1/R$$
- Conductance = Conductivity / Thickness = 1 / Resistance
- R-Value is an expression of how well a *layer* of the material resists heat flow
 - = $1 / C$

Apparent Conductance

- Measurements are actually a result of conductivity, radiation, convection
- Typical batt is
 - 35-45% radiation
 - 40-60% conduction
 - 0-20% convection
- Depending on orientation, temperature, etc

www.buildingscience.com

33

At a single mean temperature we can compare materials

Density matters

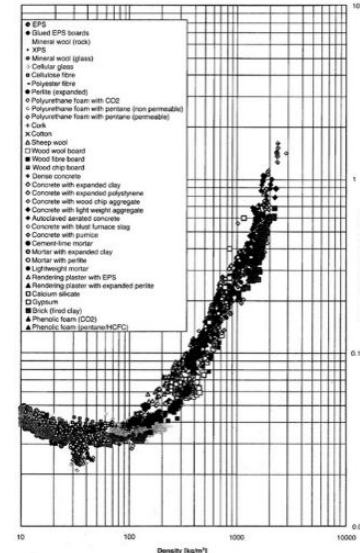

www.buildingscienc

Thermal Insulation

Insulation	R-value/inch	k (W/mK)
Empty airspace 0.75"-1.5" (20-40 mm)	R2.0 - 2.75	0.36 - 0.50 W/m²K
Empty airspace 3.5"-5.5" (90-140 mm)	R2.75	0.50 W/m²K
Batt (mineral fiber)	3.5-3.8	0.034 - 0.042
Extruded polystyrene (XPS)	5.0	0.029
Polyisocyanurate (PIC)	6.0-6.5	0.022 - 0.024
Expanded polystyrene (EPS)	3.6-4.2	0.034 - 0.040
Semi-rigid mineral fiber (MFI)	3.6-4.2	0.034 - 0.040
Spray fiberglass	3.7-4.0	0.034 - 0.038
Closed-cell spray foam (2 pcf) ccSPF	5.8-6.6	0.022 - 0.025
Open-cell spray foam (0.5 pcf) ocSPF	3.6	0.040
Aerogel	8-12	0.012-0.018
Vacuum Insulated Panels (VIP)	20-35	0.004-0.008

w

ci
ence.com

Design vs Actual

- “Safe” k or “Actual” k

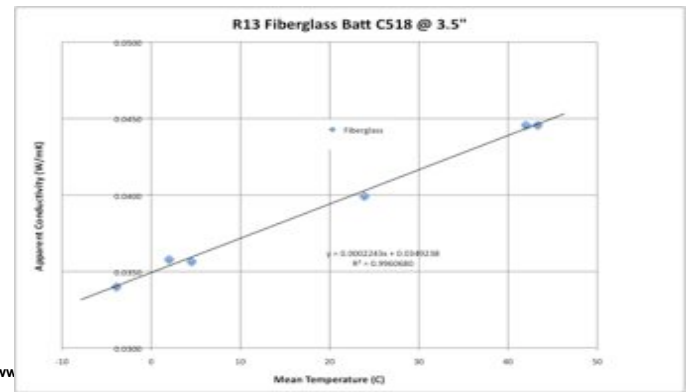

ww

Temperature

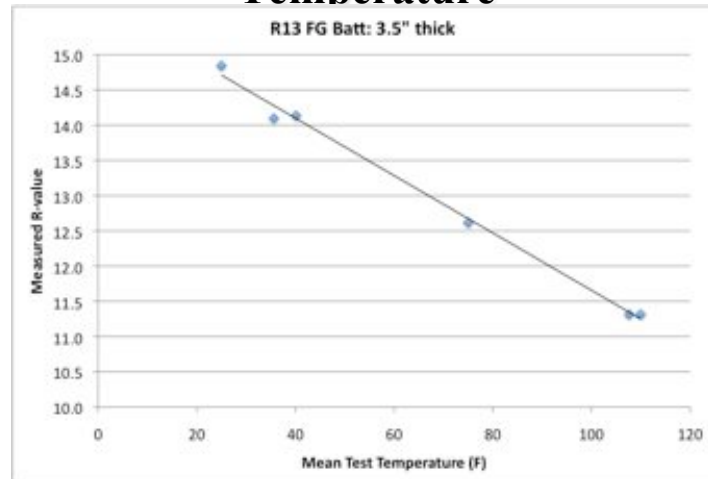

R16 High Density EPS

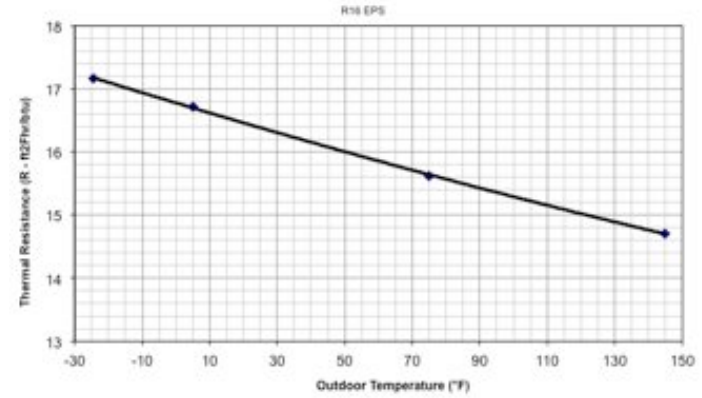

www.buildingscience.com

R20 XPS (2 months old)

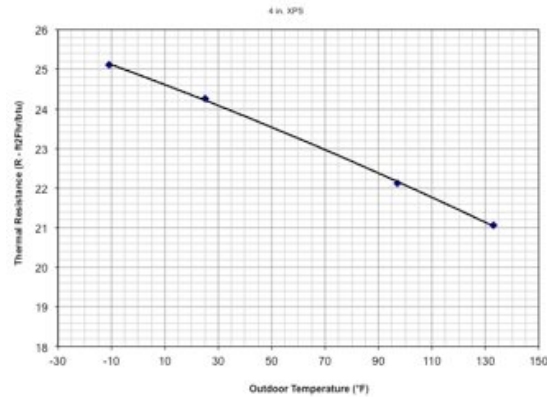

www.buildingscience.com

R20 XPS (2.4 months old)

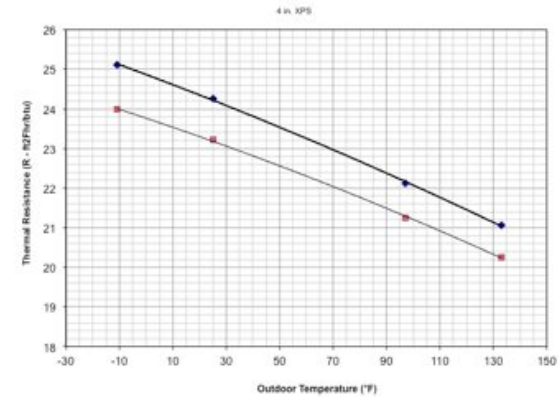

www.buildingscience.com

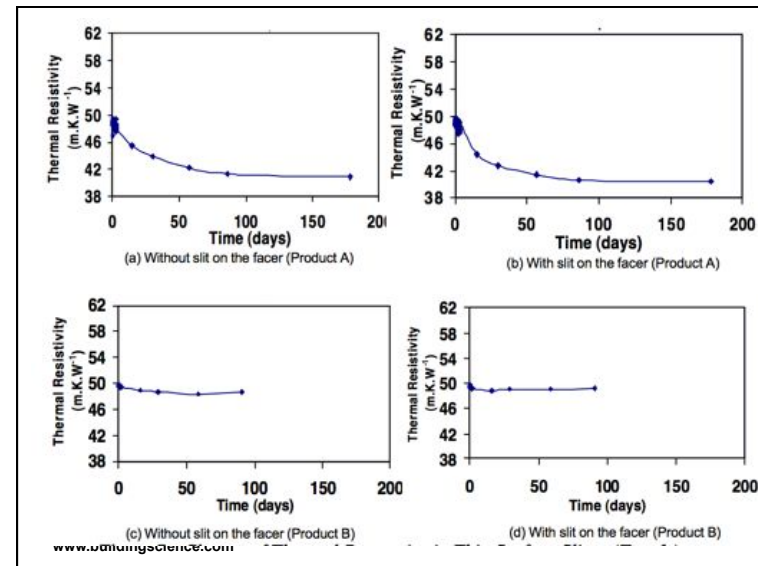
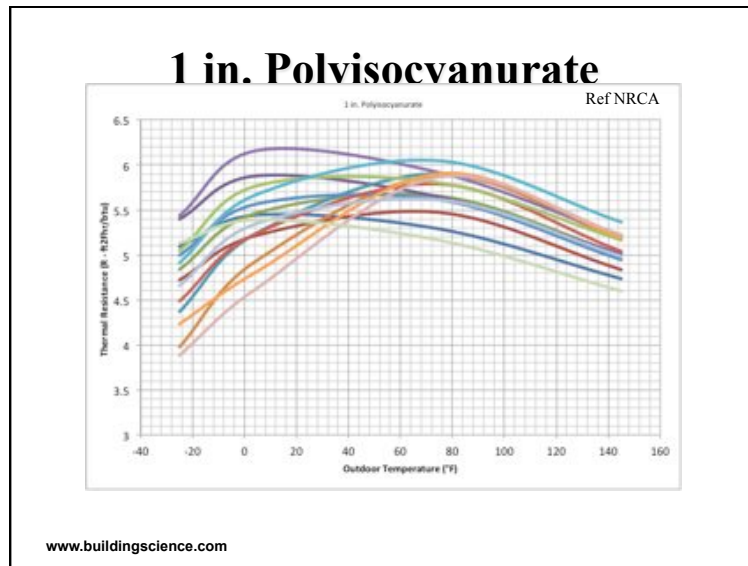
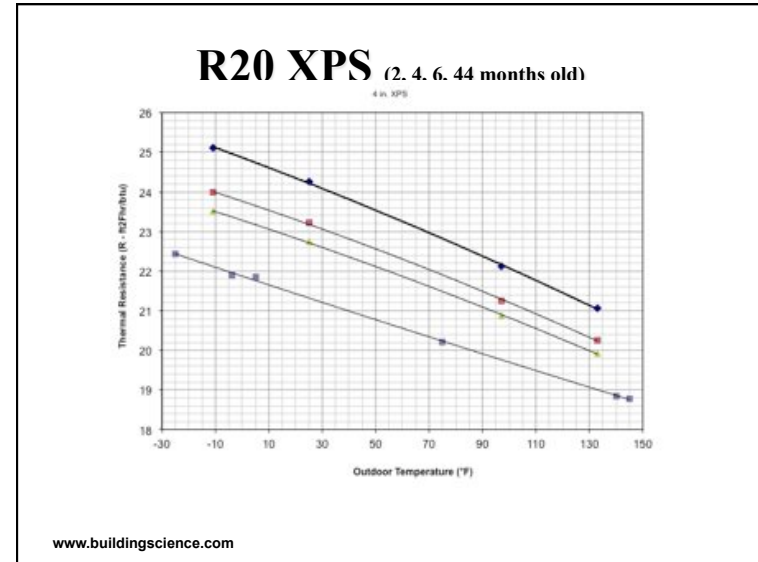
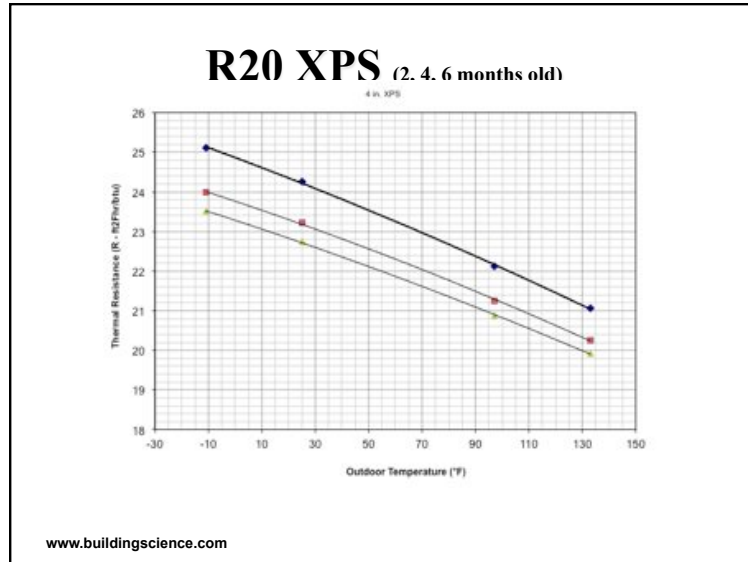

Multi-layer Assemblies

- Building enclosures are typically assemblies of several layers of different materials
- R-value of each layer

$$R_1 = l_1/k_1 = 1/C_1$$

- The overall resistance must be calculated

$$R_{tot} = R_1 + R_2 + R_3 \dots$$

- The conductance of the assembly is then

$$U = 1/R_{tot}$$

www.buildingscience.com

45

Air Spaces & Surface Films

- All 3 modes of heat transfer play a large role
- The effects are lumped into a coefficient, h_o , which can be used in the conduction equation as an *effective conductance*

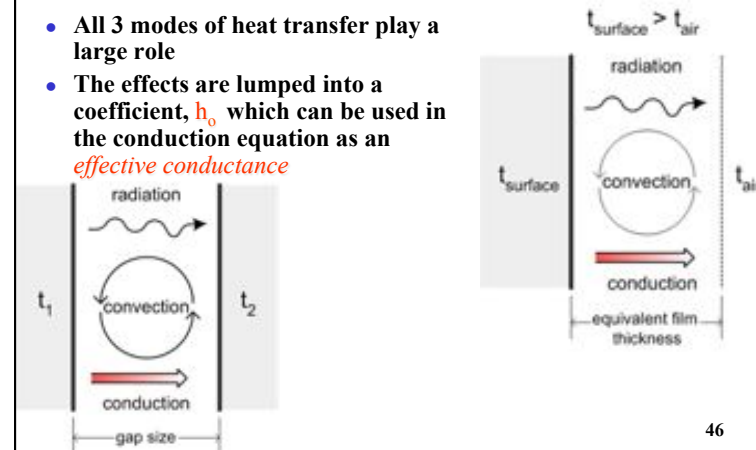

46

Air Spaces

- Airspaces are important in windows and old buildings
- Heat flow depends on heat flow *direction* and surface *emissivity*

Situation (poorly vented or sealed)	R/RSI Value	Conductance
Heat Flow Down (20-100 mm)	1.0 / 0.18	5.5
Heat Flow Across (20-100 mm)	0.96 / 0.17	5.9
Heat Flow Up (20-100 mm)	0.85 / 0.15	6.5
Reflective Airspace (Fe=0.05)	3.46 / 0.61	1.6

www.buildingscience.com

47

Surface Films

- “Surface film” is a fictitious layer with a thermal property that represents resistance to heat flow from the air to the surface
- Surface films are important to define surface temperature at poorly insulated components
 - E.g. thermal bridges, windows, old building walls
- Convection PLUS radiation
 - Both convection and radiation coefficient vary

www.buildingscience.com

48

Surface Films

Surface Position	Flow Direction	Resistance	Conductance
Still Air (e.g. indoors)		R / RSI	[W/m²K]
Horizontal (i.e. ceilings & floors)	Upward	0.61 / 0.11	9.3
	Downward	0.93 / 0.16	6.1
Vertical (i.e. walls)	Horizontal	0.68 / 0.12	8.3
Moving Air (e.g. outdoors)			
Stormy 6.7m/s (winter)	Any	0.17 / 0.03	34
Breeze 3.4m/s (summer)	Any	0.25 / 0.04	23
Average Conditions	Any	0.33 / 0.06	17

Look to *ASHRAE Handbook* or *Bldg Sci for Bldg Enclosures* for more detailed data.

www.buildingscience.com

49

But there are Complications

- Add up the R-values of the layers to get the total R-value of the assembly
- BUT the actual thermal resistance of an assembly is affected by
 - Thermal Bridges
 - Thermal Mass
 - Air Leakage

www.buildingscience.com

Building Science 2008

Insulation and Thermal

Calculating Heat Flow through an Assembly

- To calculate assembly, add layers: materials, air gaps and surface films

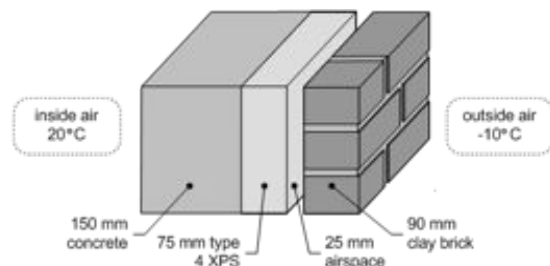

www.buildingscience.com

51

How much Insulation

- Heat Flow = $\text{Area} * \frac{(T_{\text{inside}} - T_{\text{outside}})}{\text{R-value}}$
- Double R-value, halve heat flow. Always.
- Optimum depends on
 - Cost of energy over life of building
 - Cost of adding more insulation
 - Savings in mechanical equipment, controls

www.buildingscience.com

www.BuildingScience.com

Thermal Bridges

What is a thermal bridge?

- A local area with significantly higher heat transmission (lower heat flow resistance) than
 - intended for the assembly, or
 - than the majority of the area

Types of Thermal Bridge

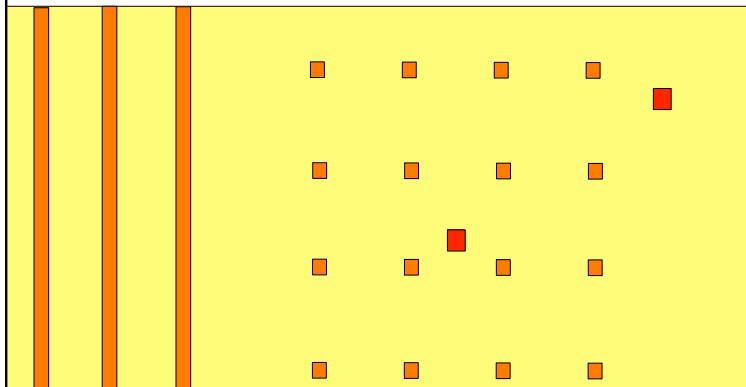

Types of Thermal Bridges

- Occurrence
 - A) Repeating
 - Non-interacting, but numerous
 - B) Unique/Special Case
 - non-interacting, but few
- Geometry
 - 1) Linear
 - 2) Point
 - 3) complex
- Can be A1 or B2 or B3, etc

Calculating Impact

- Simple area-weighted average for materials without very dissimilar properties
- Often computer calculations needed
 - 2D (linear)
 - 3D (point, complex)
- Results presented as either
 - Additional heat flow/unit
 - Total heat flow of specific area around TB

www.buildingscience.com

57

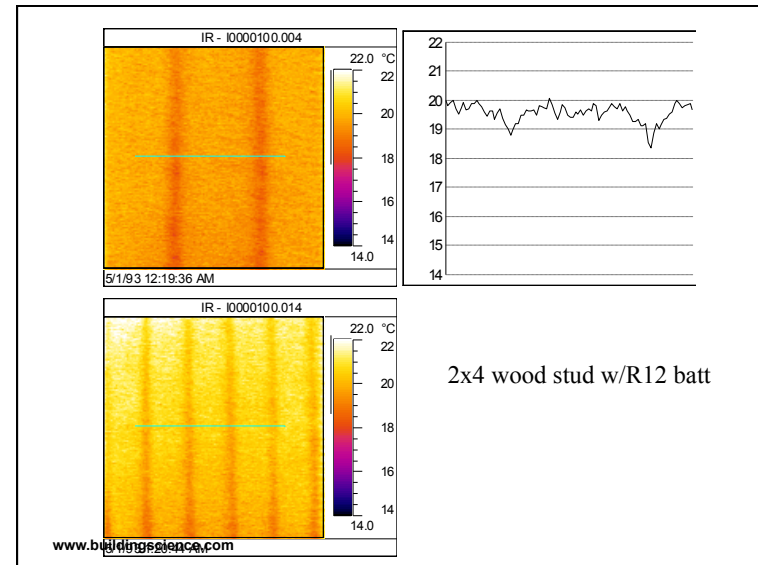
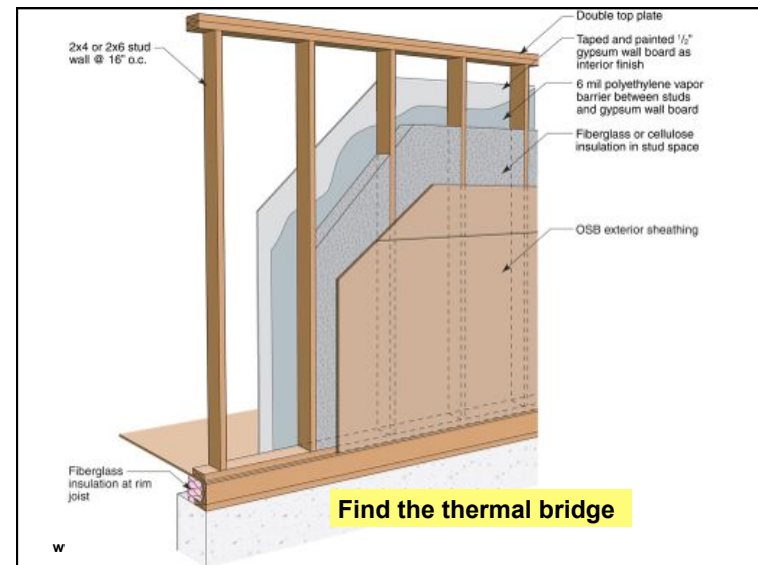



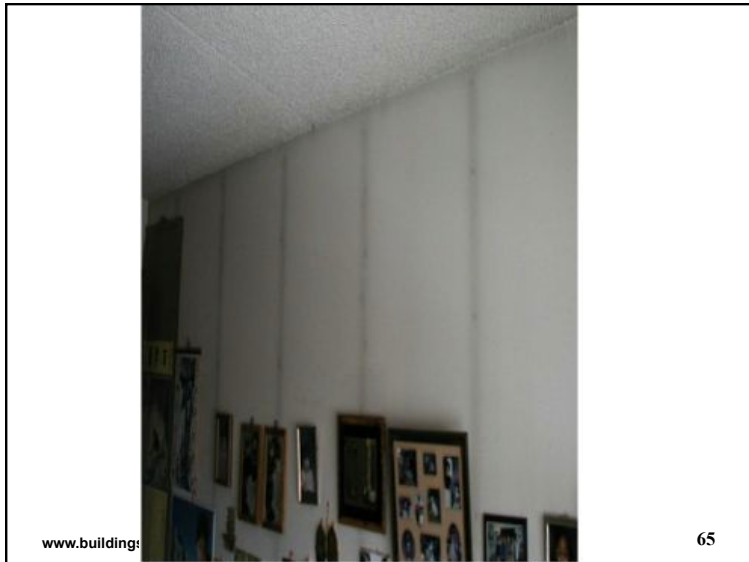

Two-dimensional heat flow

- Works for wood studs

Fig. 3 (A) Wall Assembly for Example 3, with Equivalent Electrical Circuits: (B) Parallel Path and (C) Isothermal Planes

www.buildingscience.com

Some examples

- What overall average vertical enclosure R-value should be target?
 - R5?
 - R10?
- What component (wall, window) target values should we specify to meet this?
- $R_{\text{overall}} = 1 / ((1-\text{WWR})/R_{\text{wall}} + \text{WWR}/R_{\text{window}})$
- WWR= window-to-wall Ratio

www.buildingscience.com

Thermal bridging- windows

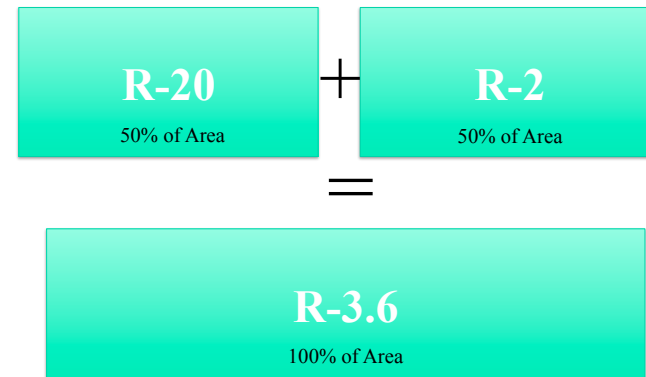

www.buildingscience.com

Thermal bridging- windows

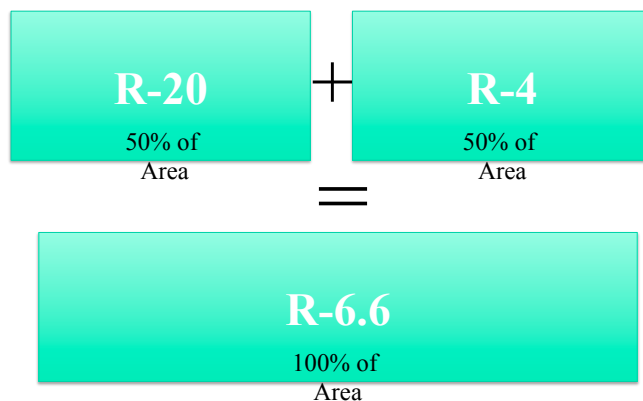

www.buildingscience.com

Add R-2 to windows, get almost half the heat loss/gain from building

Thermal bridging- windows

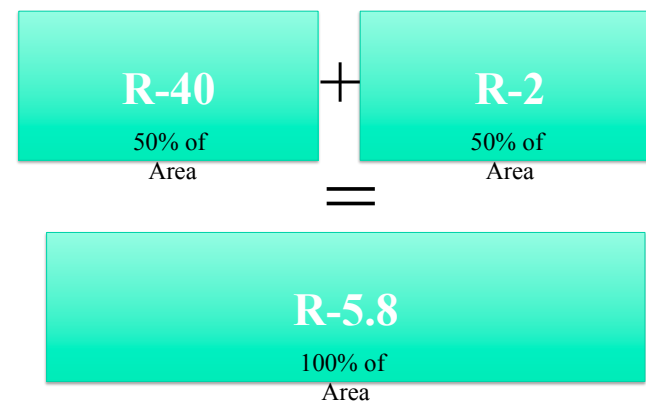

www.buildingscience.com

Adding R-20 to wall reduces less heat loss/gain than improving windows

Thermal bridging- Windows

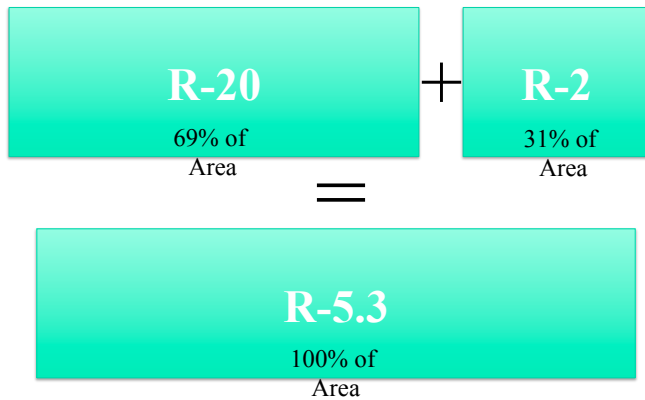

www.buildingscience.com

Thermal bridging- Windows

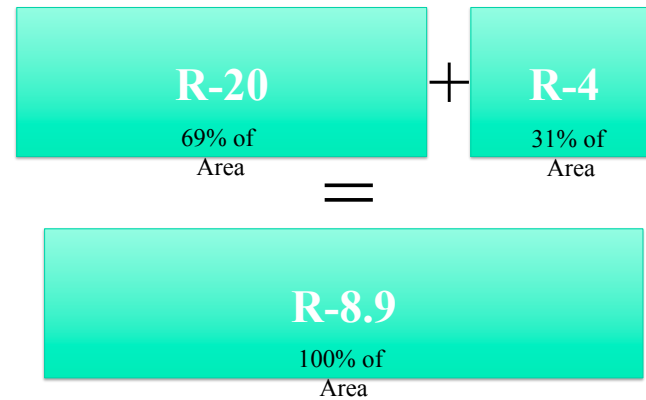

www.buildingscience.com

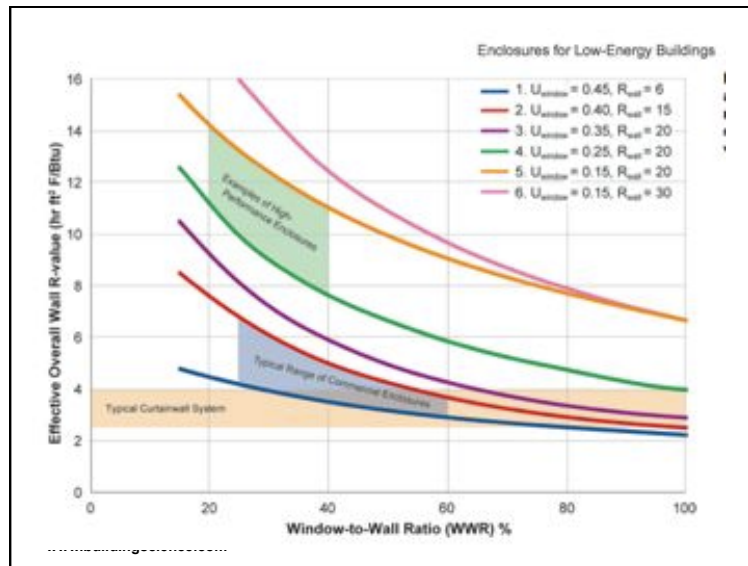

Thermal bridging- Slabs

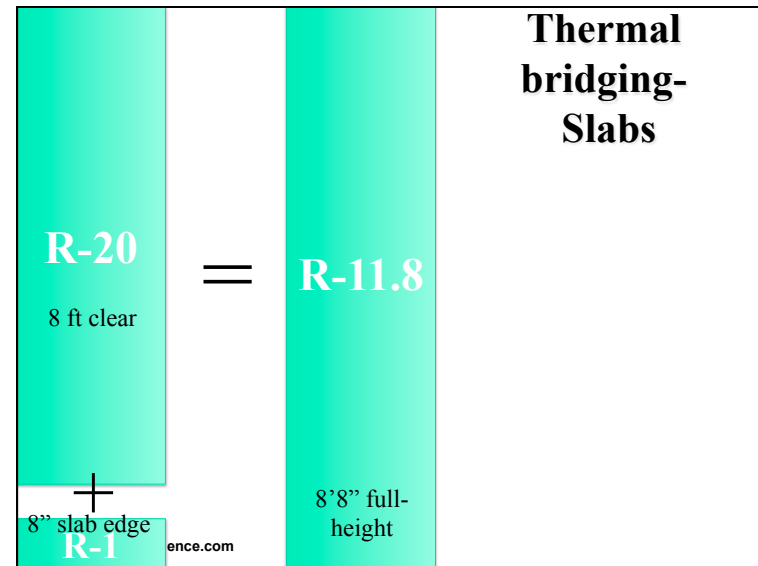

Thermal bridging- Steel stud wall

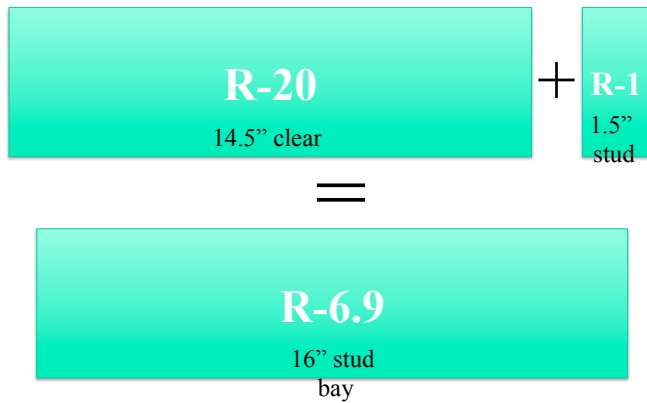

www.buildingscience.com

Thermal bridging- Slabs+studs

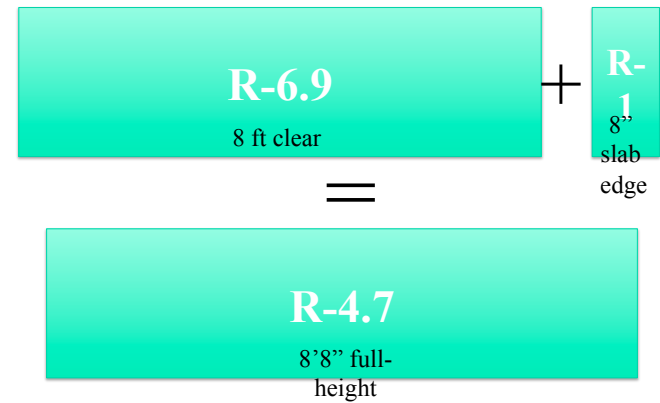

www.buildingscience.com

Thermal Bridging

- Steel is 400 times more conductive than wood
- Steel studs are about 40 times thinner

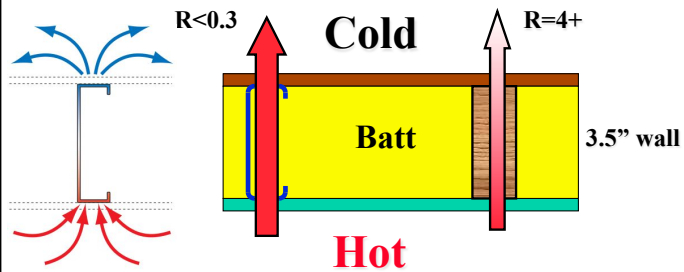

www.buildingscience.com

Building Science
Insulation and Thermal Bridging



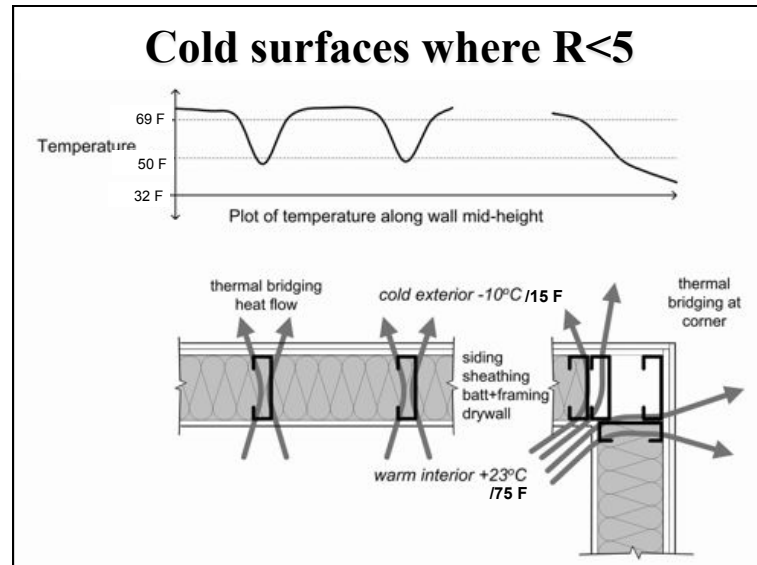
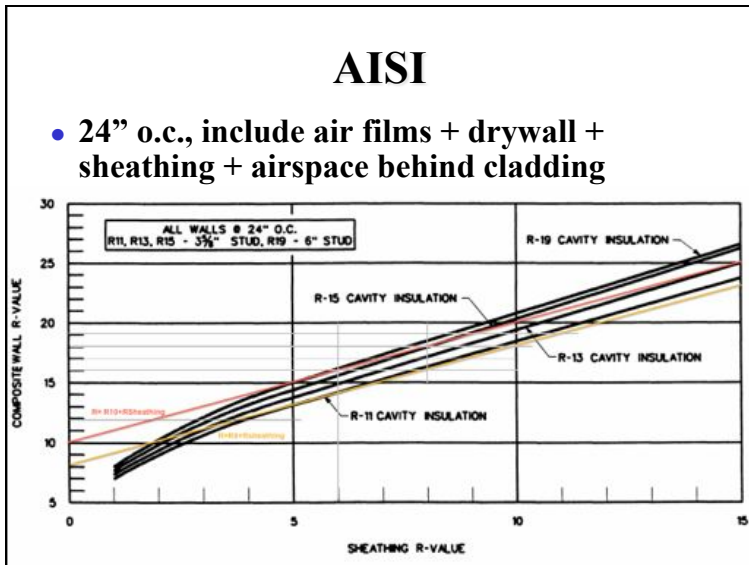
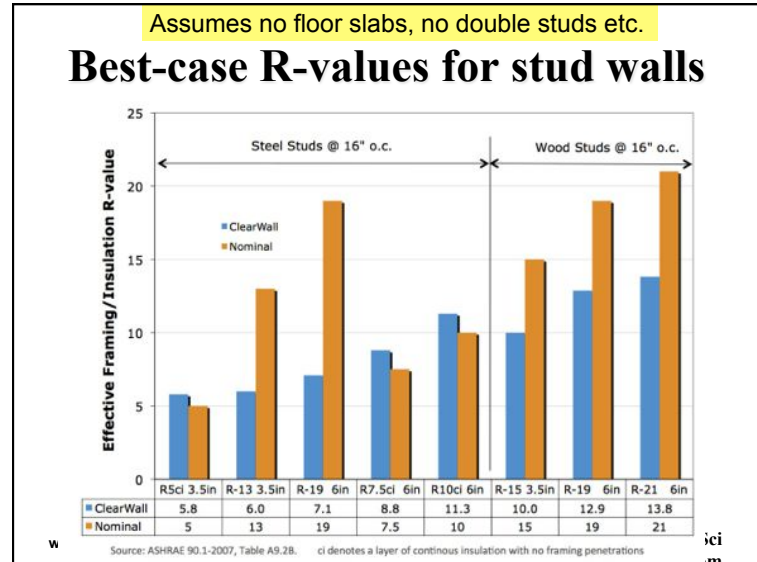
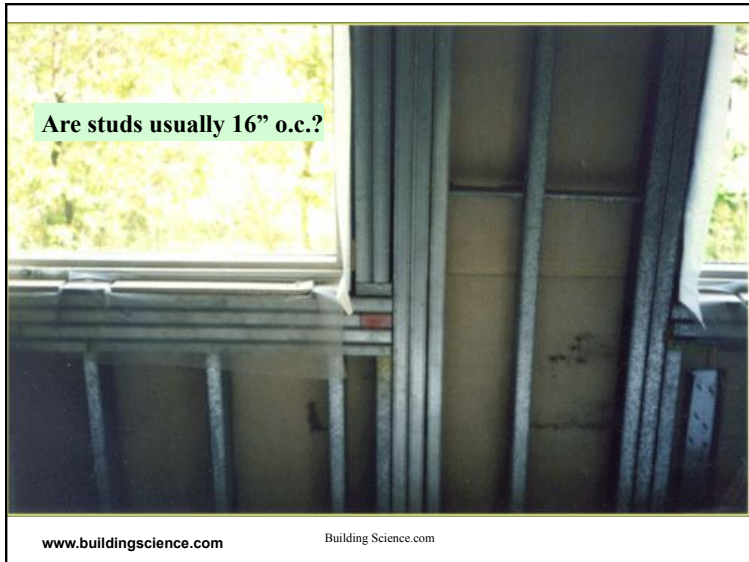

Solutions?

- A continuous layer of insulation not interrupted by structure
- E.g. insulated sheathing on the exterior

www.buildingscience.com

85

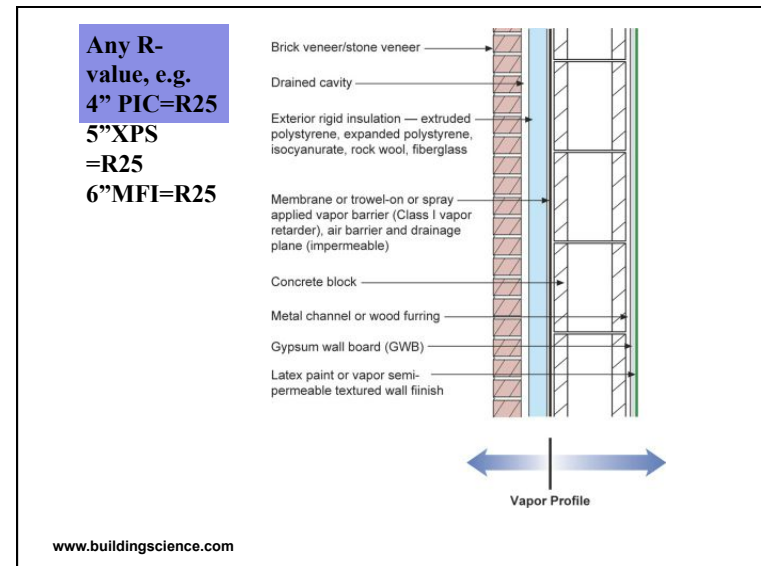
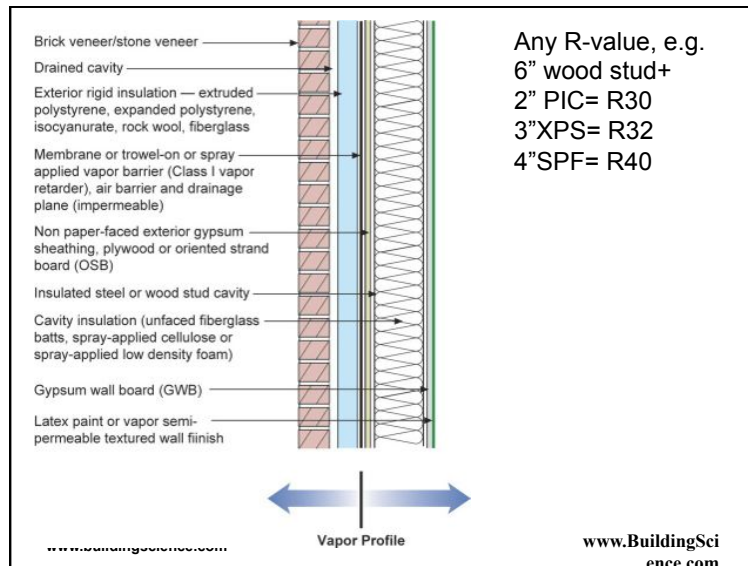

Any R-value, e.g.
 4" PIC=R25
 5"XPS=R25
 6"MF1=R25

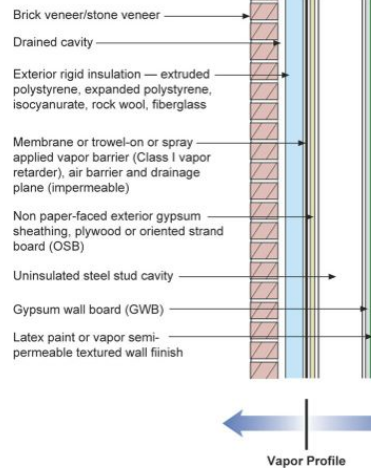

www.buildingscience.com

www.BuildingScience.com

Condensation & Drying

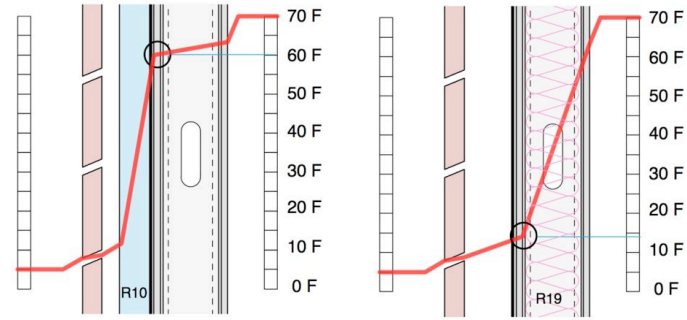

www.buildingscience.com

www.BuildingScience.com

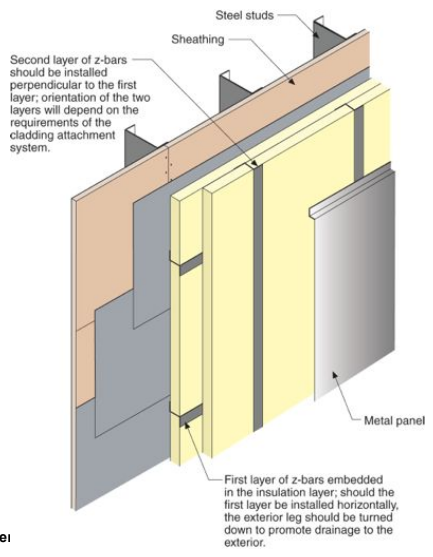

www.buildingscience.com

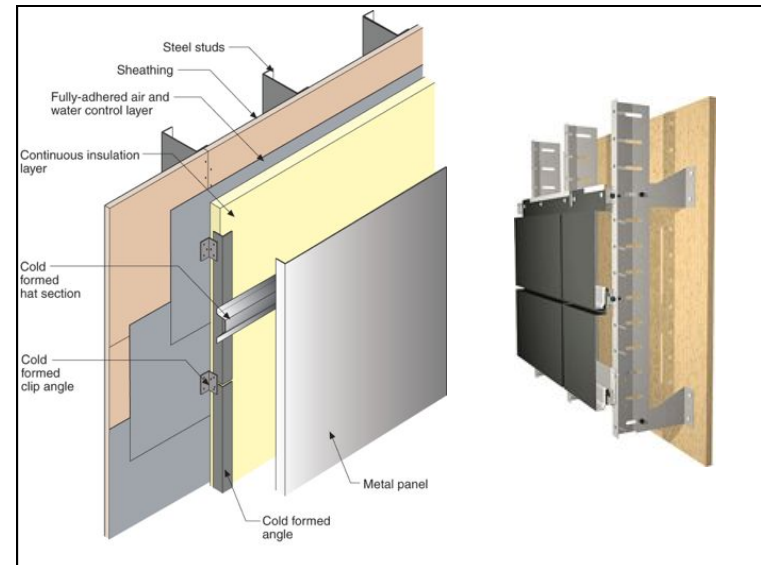

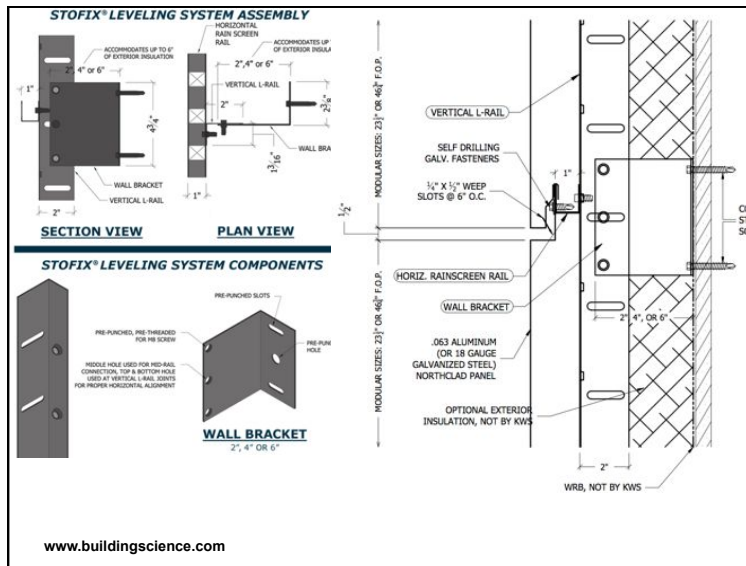
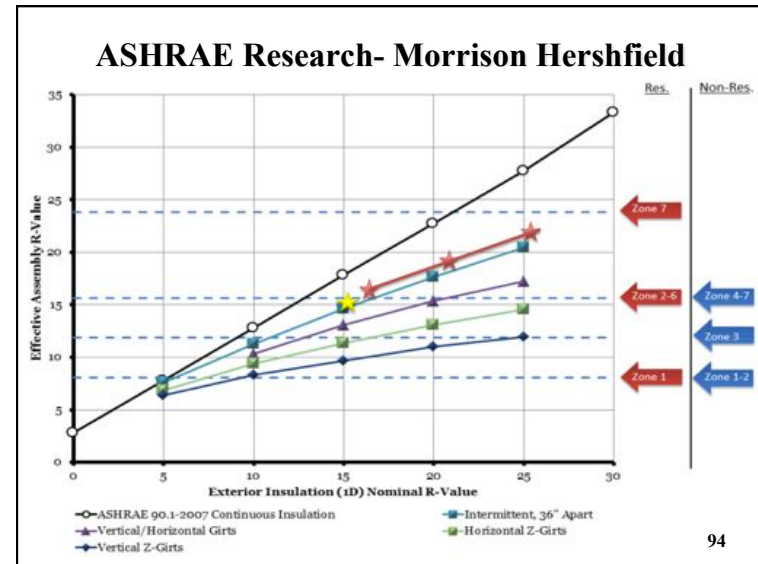
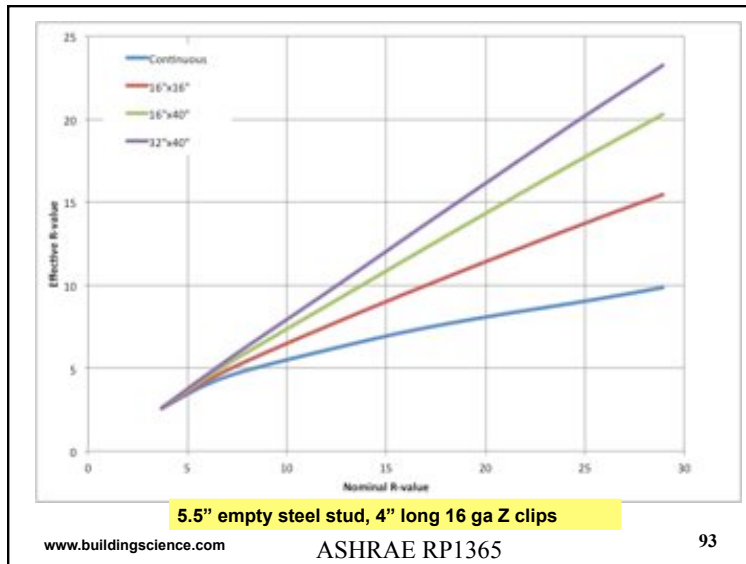



Special Cases

- Relieving angles
- Balconies
- Canopies

www.buildingscience.com

98



Can we air-cool our buildings?

07/12/2011

Schöck Isokorb®: Thermally protective and load-bearing From: www.schoeck-canada.com

Free cantilever balconies are, and have always been, an important asset to any construction project, helping obtaining a higher quality of living. When a balcony slab without a thermal break at the perimeter is cast, it creates a thermal bridge.

The **Schöck Isokorb®** can eliminate this "Weak Link" in the building envelope. Effective thermal insulation of the Schöck Isokorb® reduces the risk of condensation, mold formation and associated damage caused by this effect.

Thermal leakage and energy loss is minimized with Isokorb®. The optimum thermal insulation of Isokorb® is found in the highly effective HCFC-free insulation layer made from Polystyrol foam, used together with stainless steel load transferring members.

Award-winning Aqua Tower

www.buildingscience.com

Auto °C 0.3
~11.3
-30.0
0.95 22.0 100% 0.9344

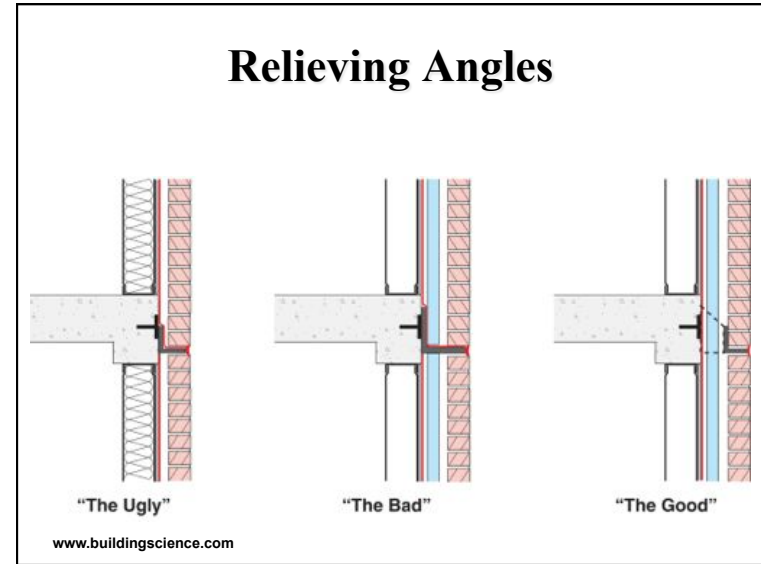
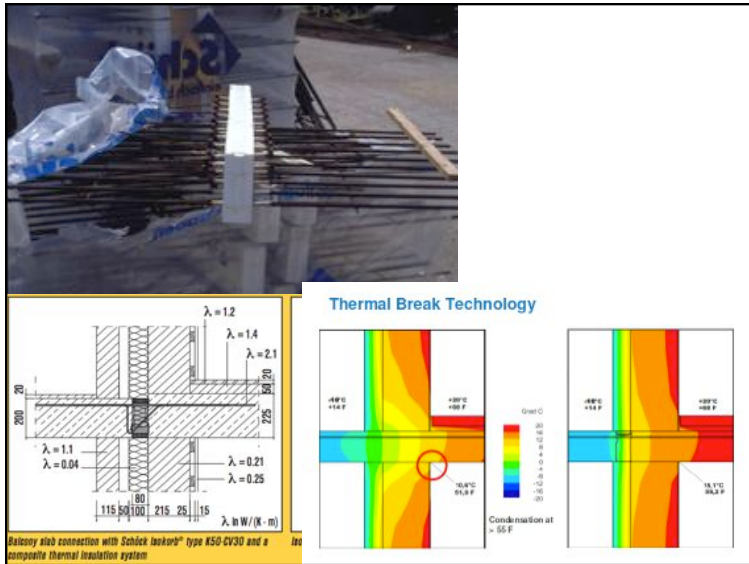

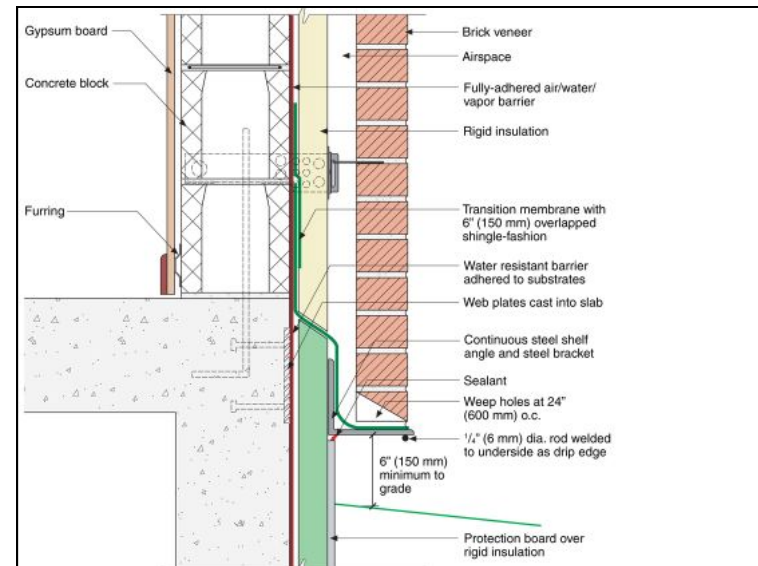
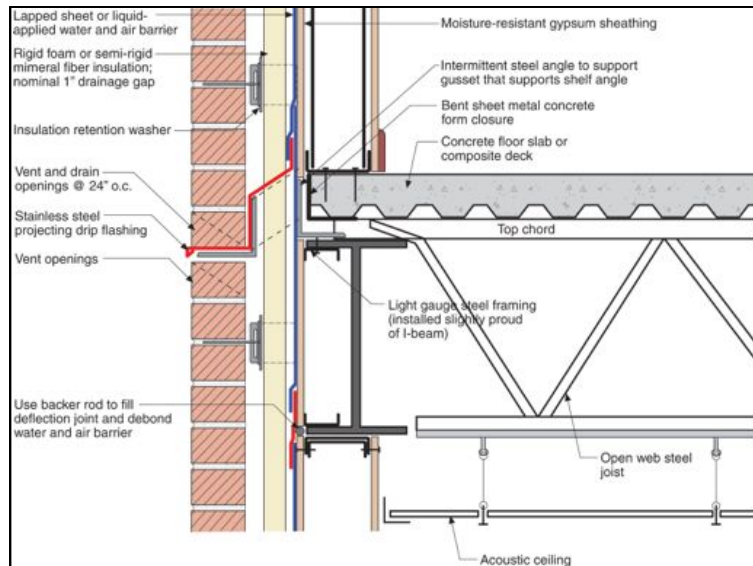
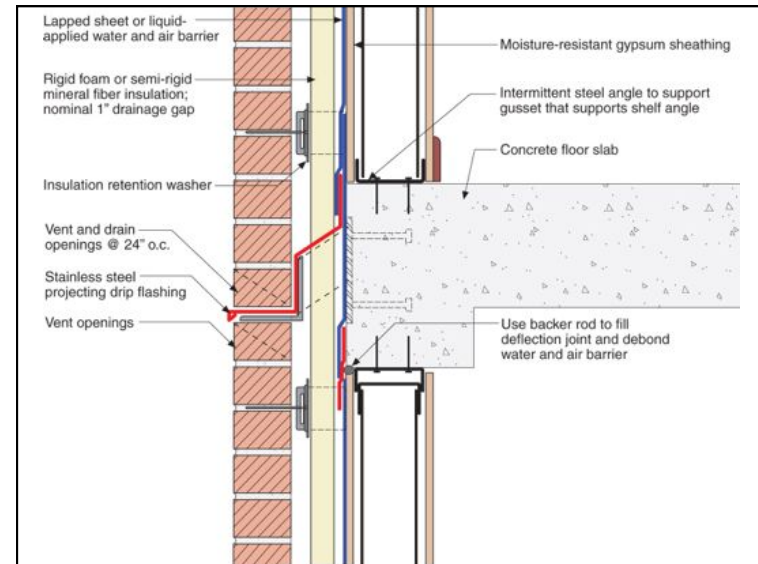

Balconies

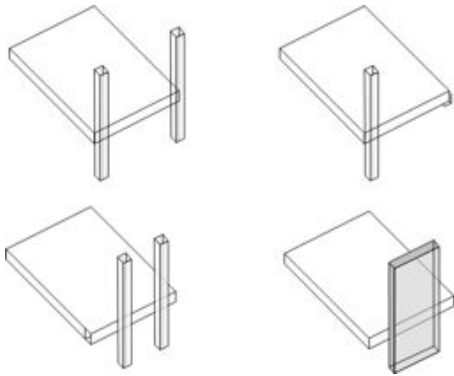

www.buildingscience.com

Building Science 2008

Insulation and Thermal



www.buildingscience.com

Building Science 2008

Insulation and Thermal



www.buil

www.BuildingSci
ence.com



www.buildingscience.com

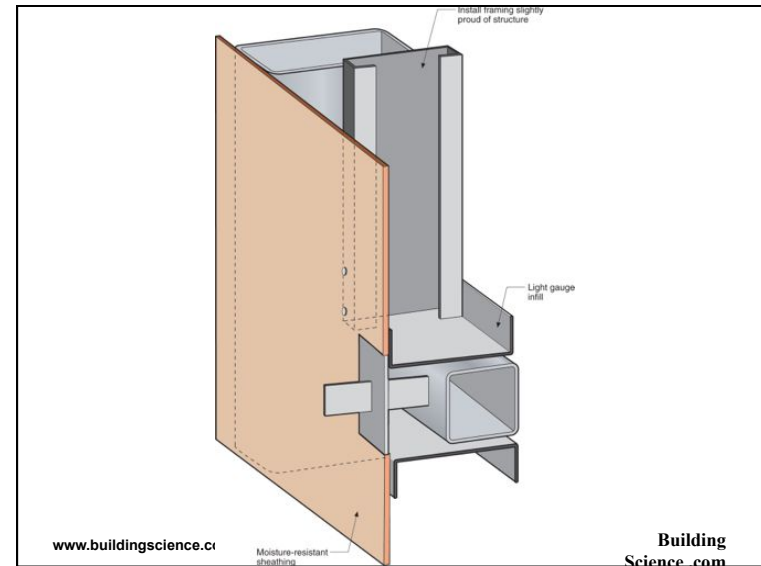
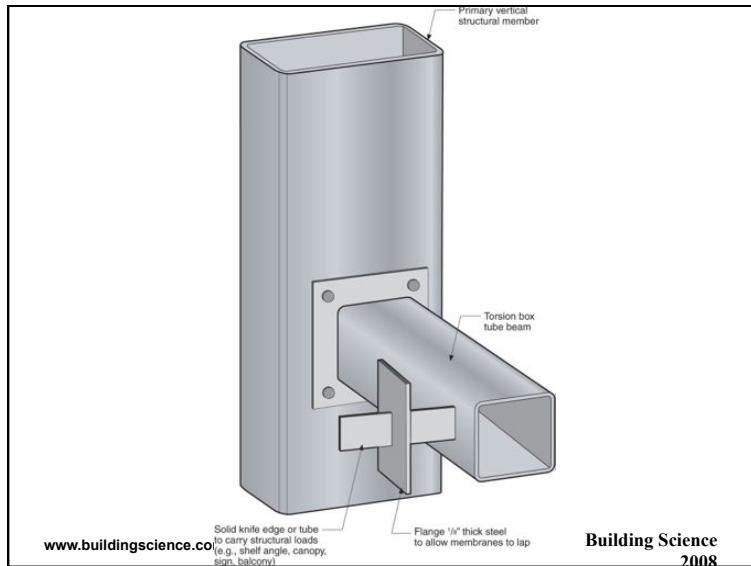
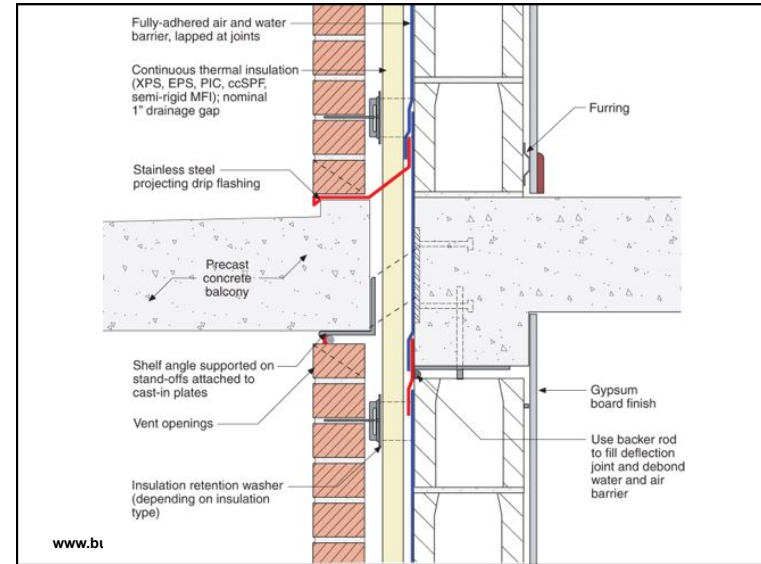

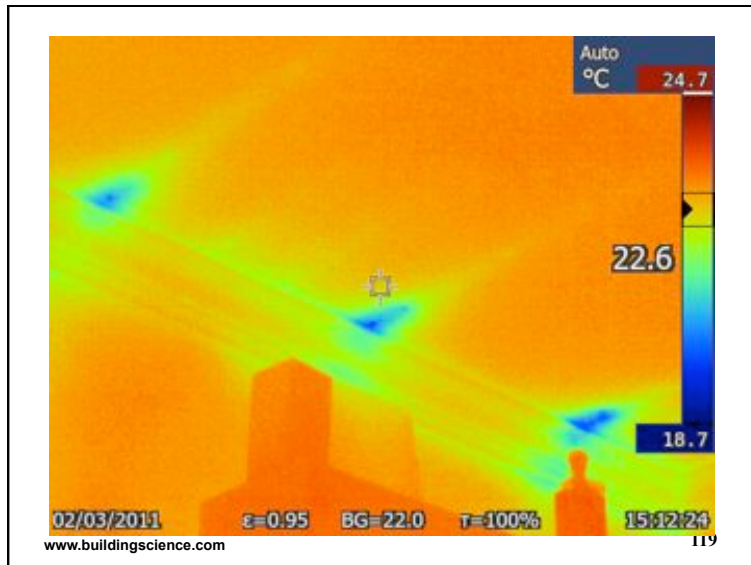
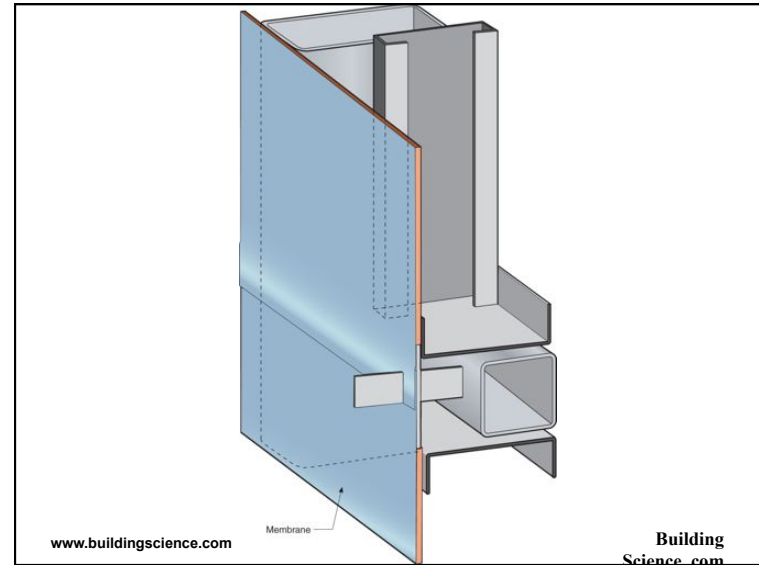
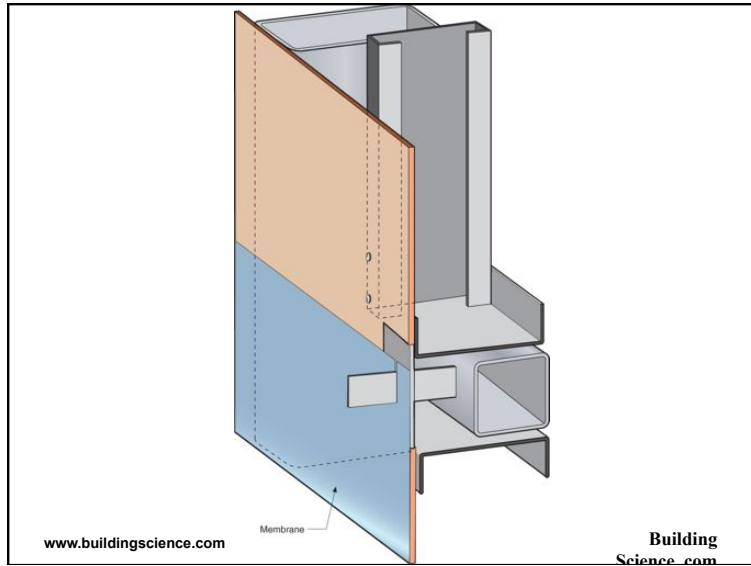

Windows

... such a pane.

www.buildingscience.com 120

Windows

- Our most expensive thermal bridges
- Aluminum is 4-5 times as conductive as steel
- Or 1600 times more than wood
- Difficult to buy commercial aluminum windows / curtainwall over R3.
- Allow solar heat in
 - Useful in cold weather
 - Requires cooling in summer

www.buildingscience.com

www.BuildingScience.com

Frames

- A large amount of heat can also be conducted through the frame
 - Conductivity of the material (lower = better)
 - Geometry of the frame

Frame Material	Conductivity W/mk	Conductivity R/inch
Wood	0.10 to 0.18	0.8 to 1.4
PVC	0.17	0.8
Fiberglass	0.30	0.5
Bronze	93	0.002
Aluminum	221	0.001

www.buildingscience.com

Building Science

Windows and Curtainwalls

Gas Fills

- Gas fills reduce the amount of heat transferred by conduction and convection through the space in the glazing unit
- Gas fills leak about +/-1% per year

Fill	Conductivity W/mK	Conductivity R/inch	Reduction in Conduction
Air	0.0241	6.0	-
Argon	0.0162	8.9	33%
Krypton	0.0086	16.8	64%
Xenon	0.0051	28.3	79%

www.buildingscience.com

Building Science

Windows and Curtainwalls

Window U-values

- Window U-value = 1 /R-value
- Window values usually include airfilms
 - Inside and outside R-1.0
- Hence, single-glazed, R1
- A still air space adds R1
- Change to argon, another R1
- Add low-e, another R1

www.buildingscience.com

124

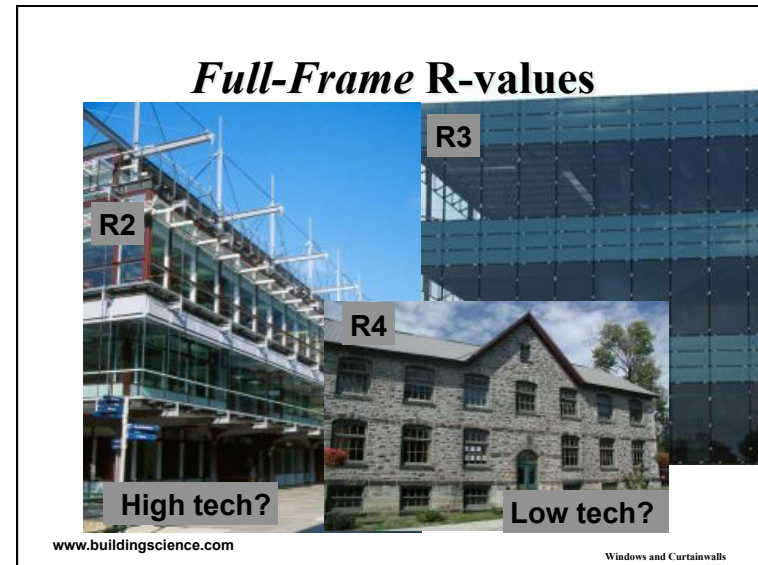
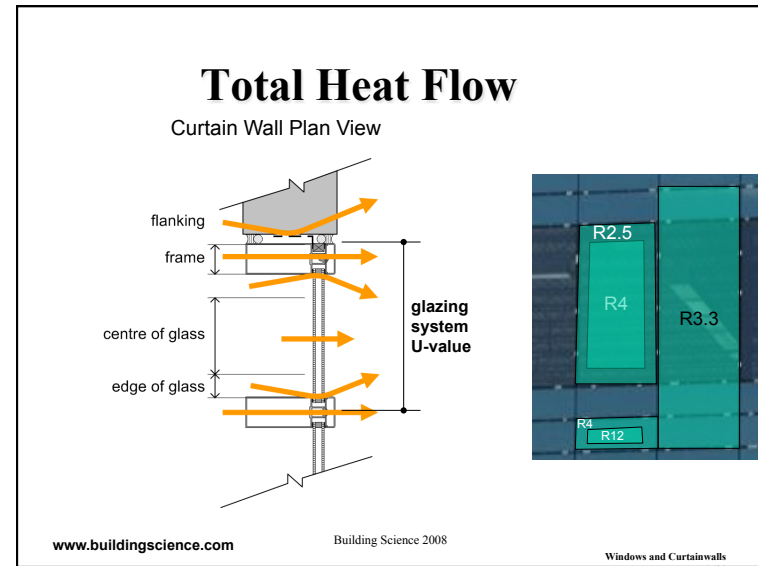
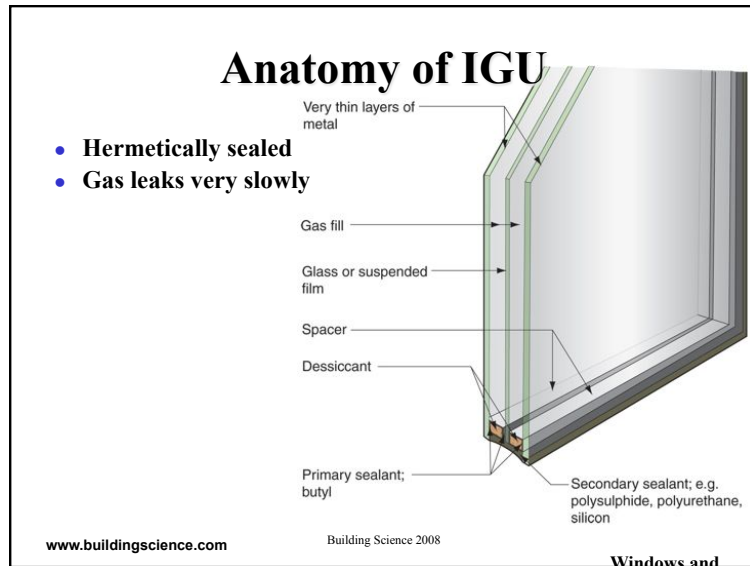

Thermal Break

- Critical for alu windows
- 1/2" should be min thermal break

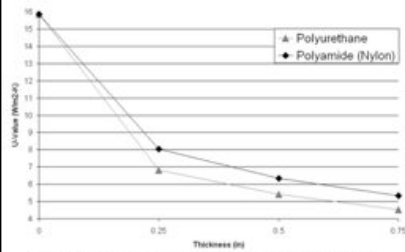
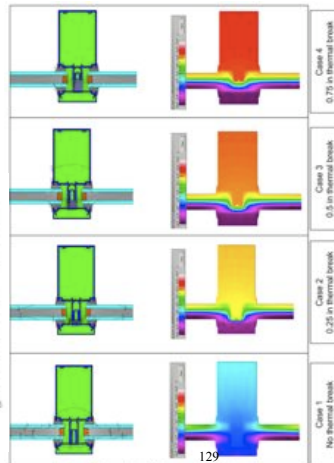

Figure 4: Frame U-Value vs. thermal break thickness.

www.buildingscience.com

129



High Performance

Getting better . .

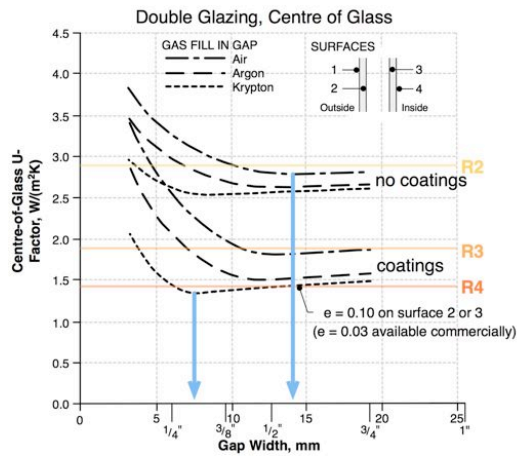

www.buildingscience.com

www.BuildingScience.com

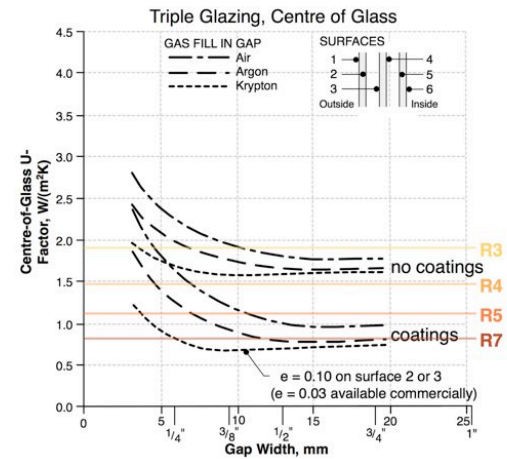

www.buildingscience.com

www.BuildingScience.com

Industry Leading Performance	Center of Glass (COG) Performance*				AlpenGlass+™	
	U-Value	R-Value	SHGC	VT	Glazing	Fill
	0.05	20.00	0.29	0.44	Dual Pane, Triple Low Solar Heat Coefficient Film	Xenon
Premium Performance	0.07	14.29	0.24	0.43	Dual Pane, Dual Low Solar Heat Coefficient Film	Krypton
	0.11	9.09	0.51	0.65	Dual Pane, Dual High Solar Heat Coefficient Film	Krypton
High Performance	0.11	9.09	0.30	0.55	Dual Pane, Single Low Solar Heat Coefficient Film	Krypton
	0.19	5.26	0.60	0.73	Dual Pane, Single High Solar Heat Coefficient Film	Krypton

*Performance numbers are center of glass values based on EPNE Window 8.2 software.

Courtesy of ThermoProof Windows and AlpenGlass+



Flanking

- Defined as heat flow around a window
- Includes the rough opening and any special flashing, fasteners, etc.
- Wood bucks often have R-value of 1/inch
- Plywood bucks usually 0.75/inch
- Air gaps >1/4" have low R-value
- Gaps filled with spray foam, R4-6/inch

www.buildingscience.com

135

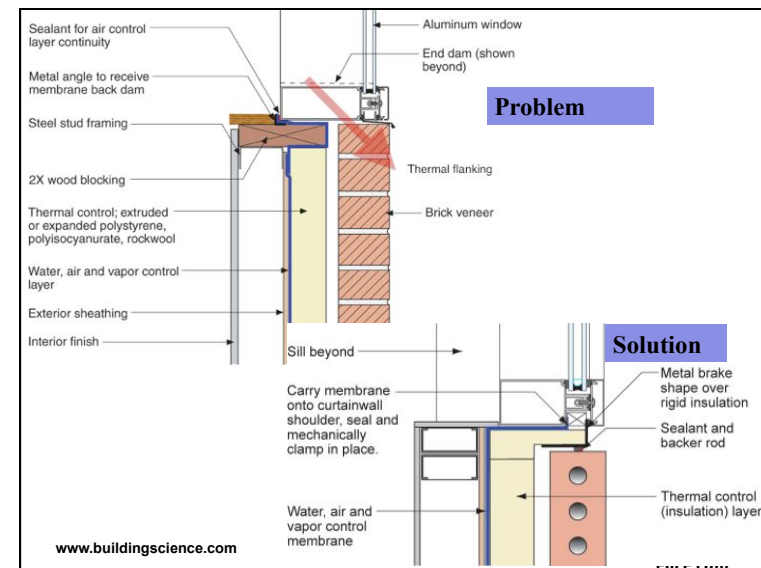

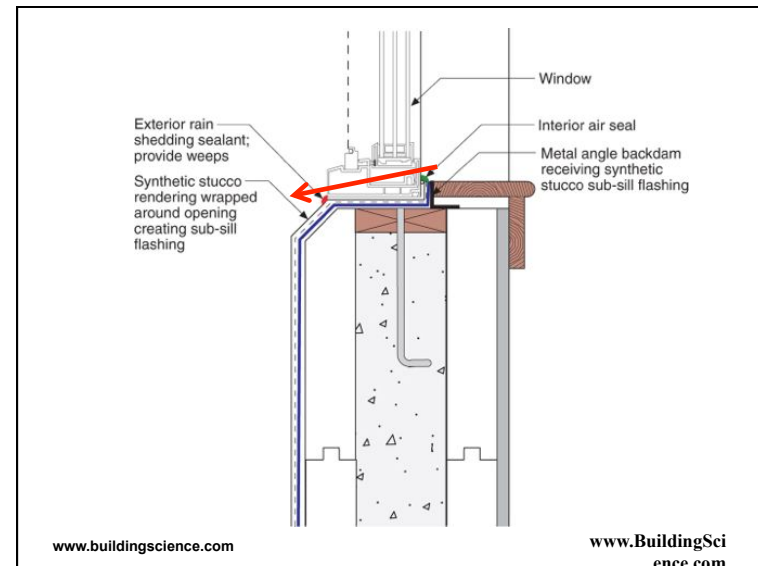
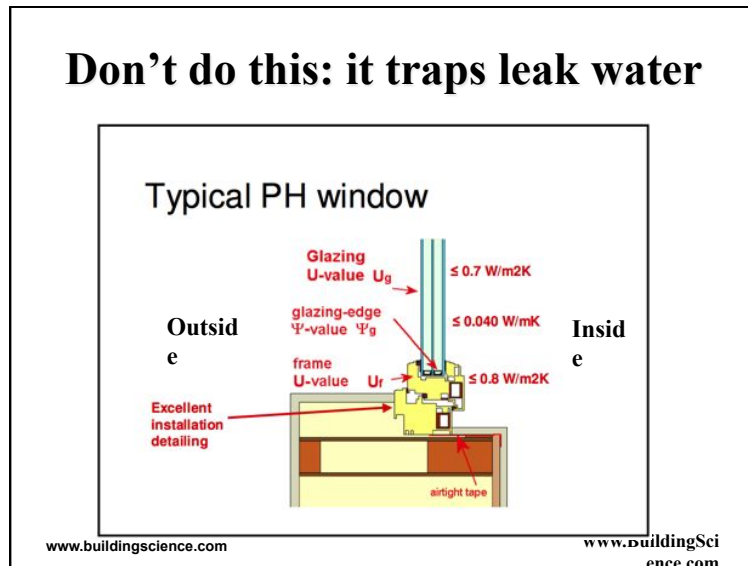
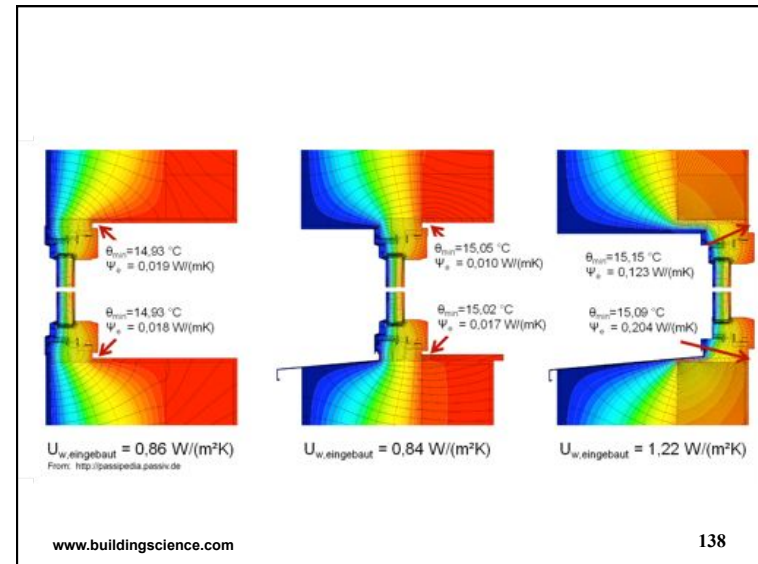
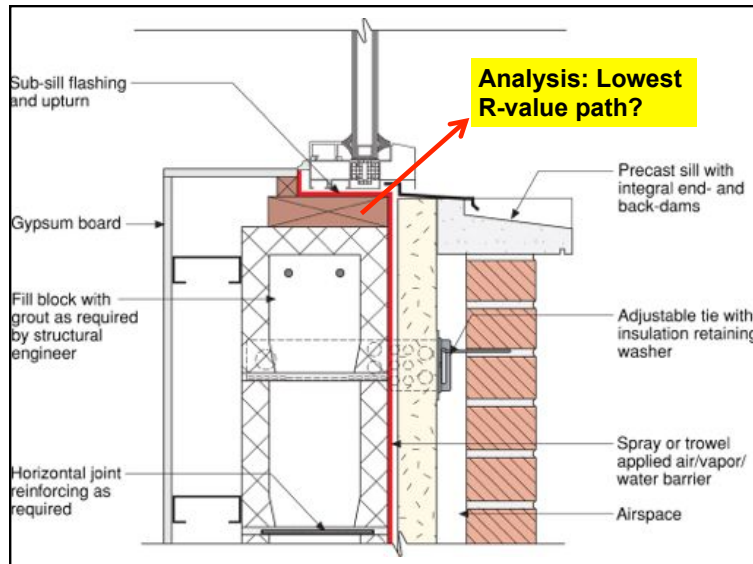

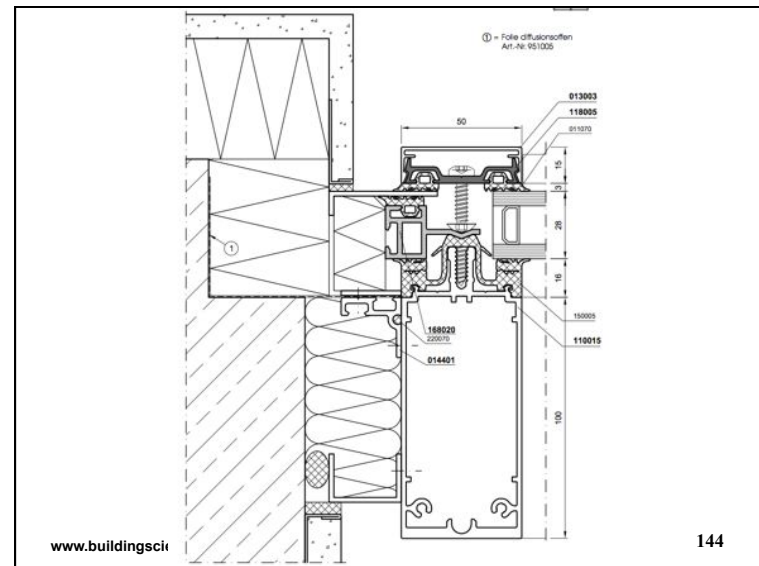
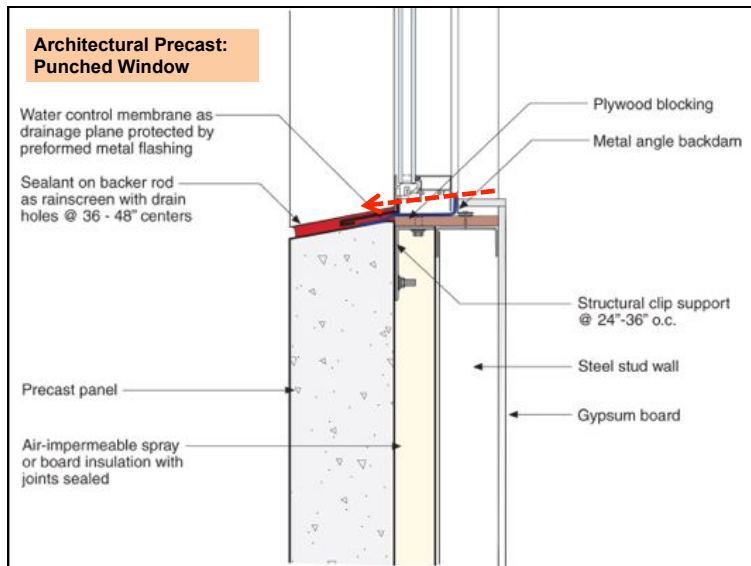
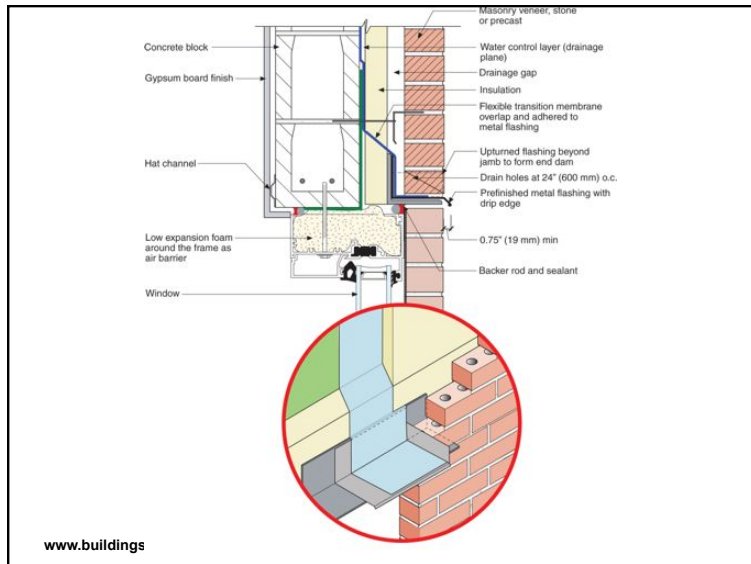

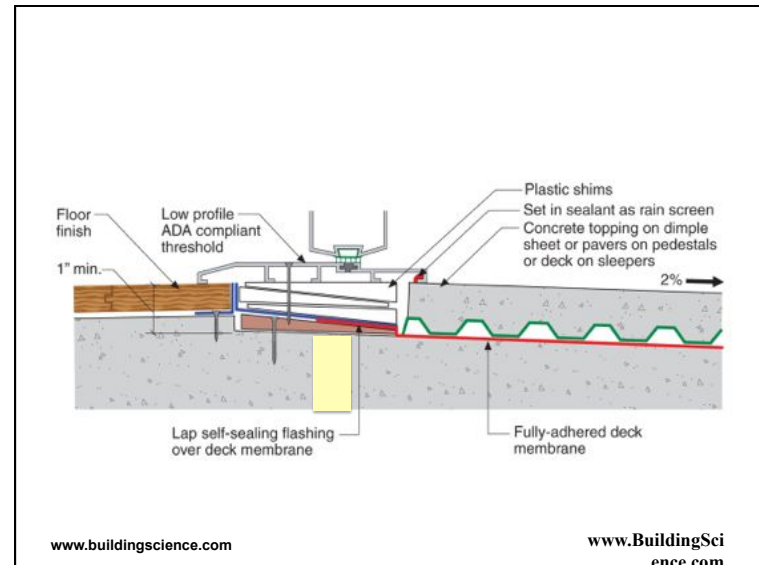
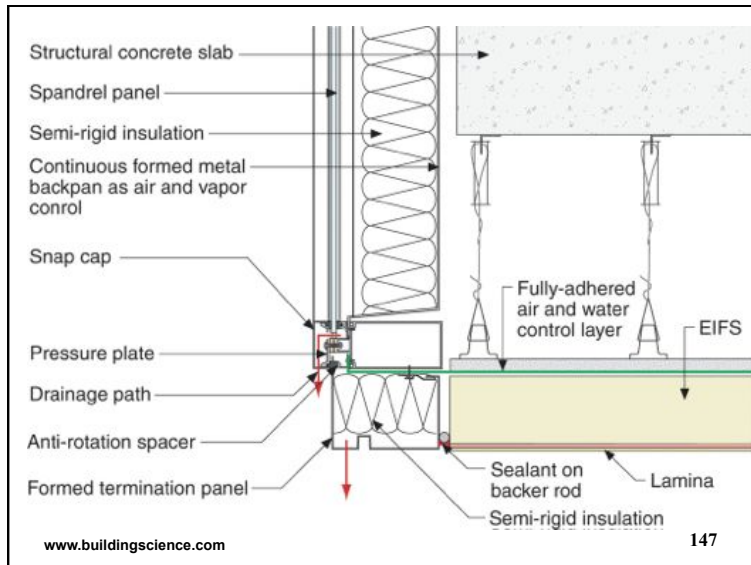
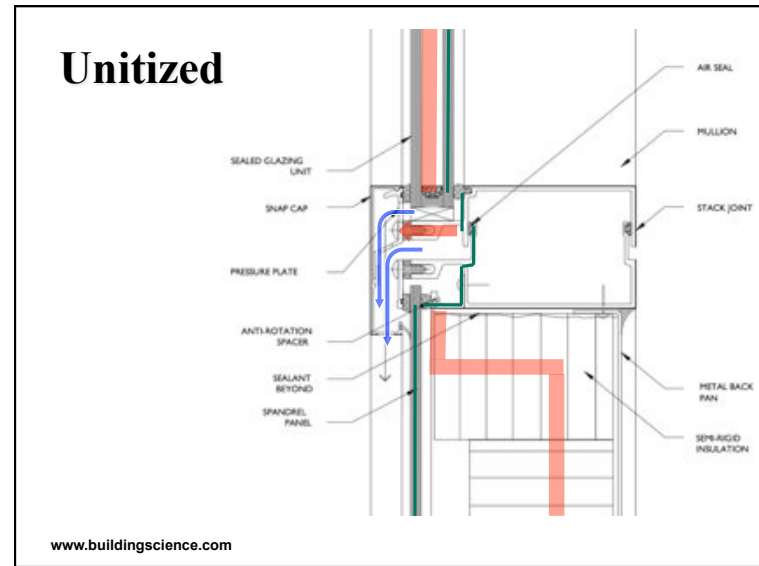
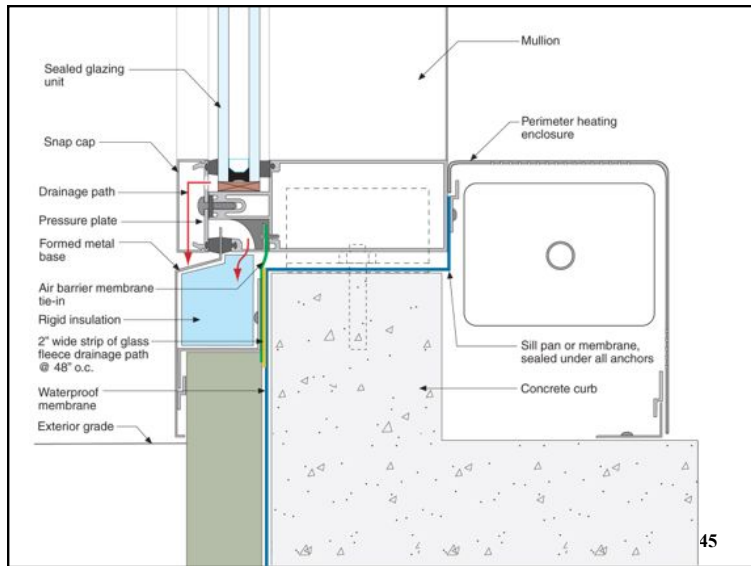

Total Window

- Remember for total window installed, need to consider
 - IGU
 - Spacer
 - Window frame
 - Rough opening

www.buildingscience.com

149

Window Overall U-value

$$U_W = (U_C A_C + U_E A_E + U_f A_f) / A_W$$

where

U_W = U-value of complete window product

U_C = calculated centre of glass U-value

U_E = calculated edge of glass U-value

U_f = calculated frame U-value

A_C = centre of glass area

A_E = edge of glass area

A_f = frame area

A_W = total window area

www.buildingscience.com

150

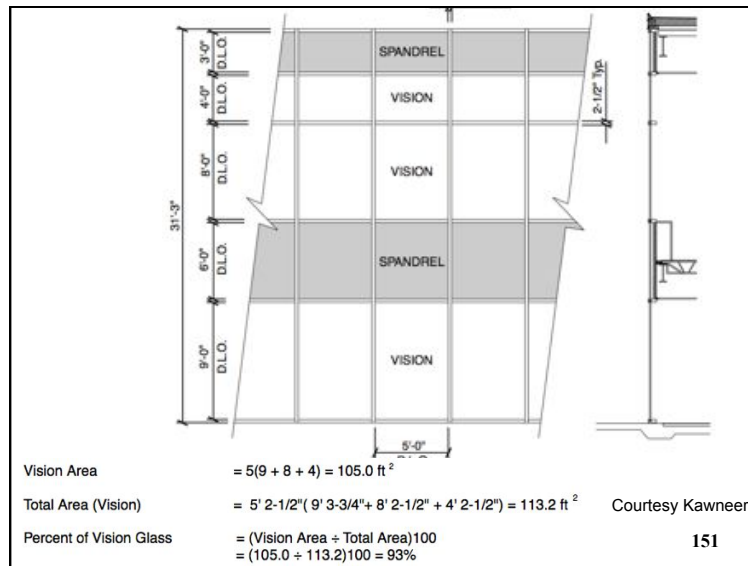

151

Example Kawneer 1600

System U-Factors for Vision Glass

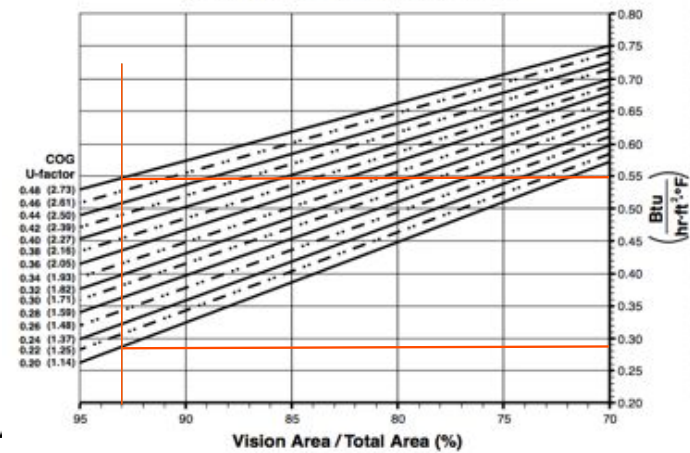

ww

Glazing size matter

Example: curtainwall

4' x 4' lite size (4' x 4') = 16

Total Area: (4'2.5" x 4'2.5") = 17.71

Percent Vision: 90%

Example: punched window

2'6" x 6' clear glass size = 15

Total Area: (2'6" x 5") = 18.71

Percent Vision: 80%

www.buildingscience.com

153

Example Kawneer 1600

System U-Factors for Vision Glass

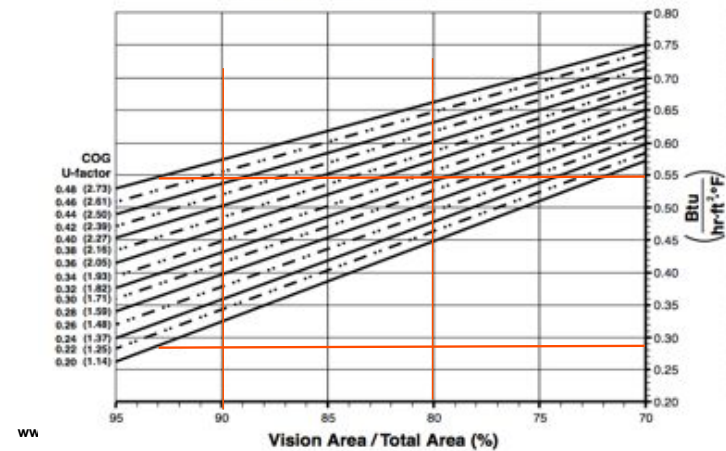

Example Kawneer 7550

For configuration as shown with height (h) equal to width (w).

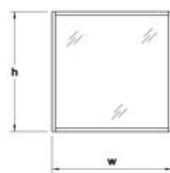

7525 - DOUBLE SEALED UNIT TYPE

A = 6mm clear / 1/8" argon / 6mm low-e¹ / metal spacer

B = 6mm clear / 1/8" argon / 6mm low-e¹ / warm edge spacer³

C = 6mm clear / 1/8" argon / 6mm low-e² / warm edge spacer⁴

7550 - TRIPLE SEALED UNIT TYPE

D = 6mm clear / 1/8" argon / 6mm low-e¹ / 1/8" argon / 6mm low-e¹ / metal spacer

E = 6mm clear / 1/8" argon / 6mm low-e¹ / 1/8" argon / 6mm low-e¹ / warm edge spacer³

F = 6mm clear / 1/8" argon / 6mm low-e² / 1/8" argon / 6mm low-e² / warm edge spacer⁴

1 - low-e coating emittance = 0.1

2 - low-e coating emittance = 0.03

3 - Helima thermally broken spacer

4 - Edgetech Super "U" Spacer®

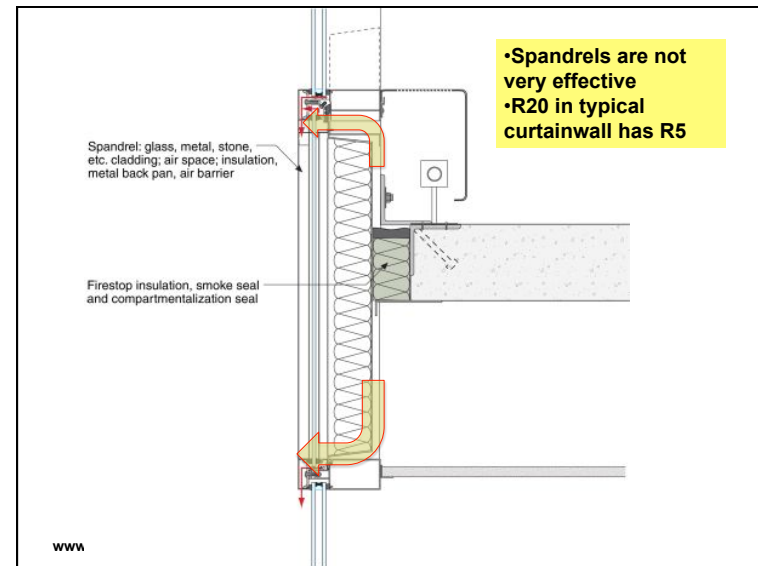
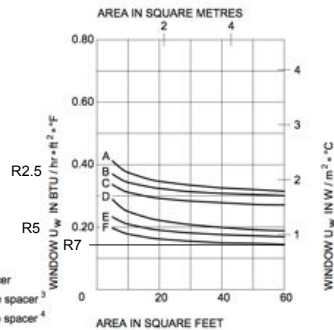



157

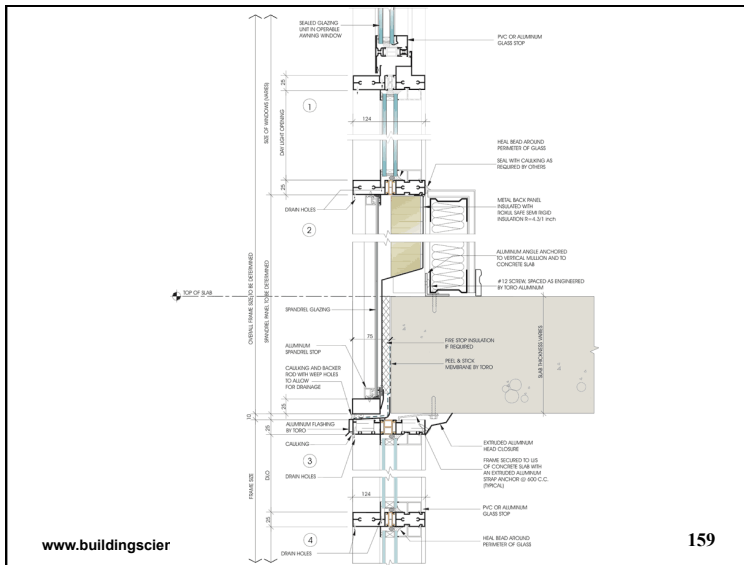
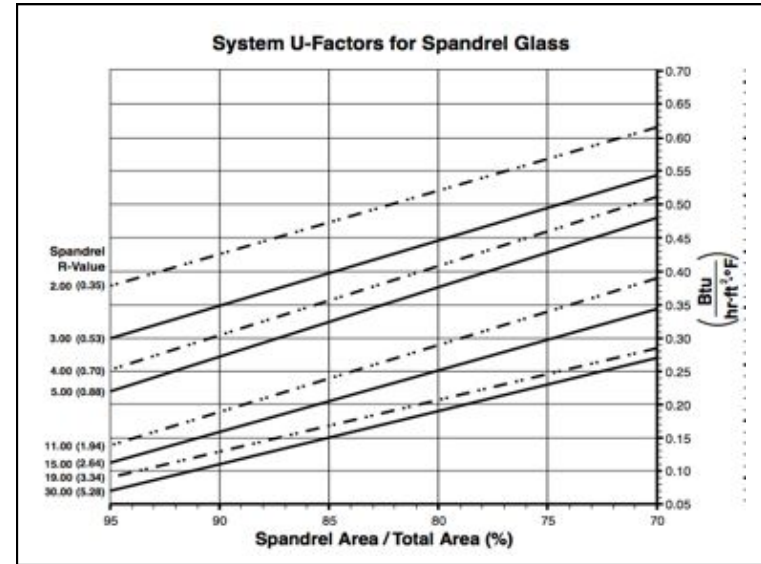

159

Total System Impacts

www.buildingscience.com

160

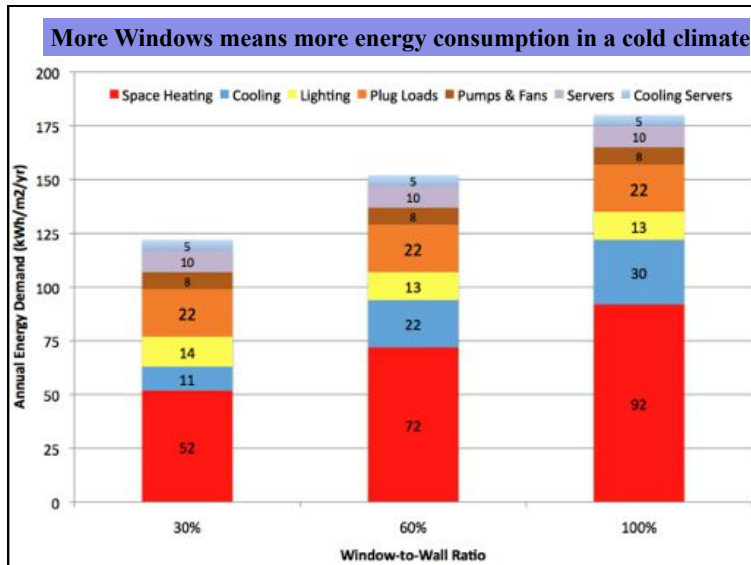
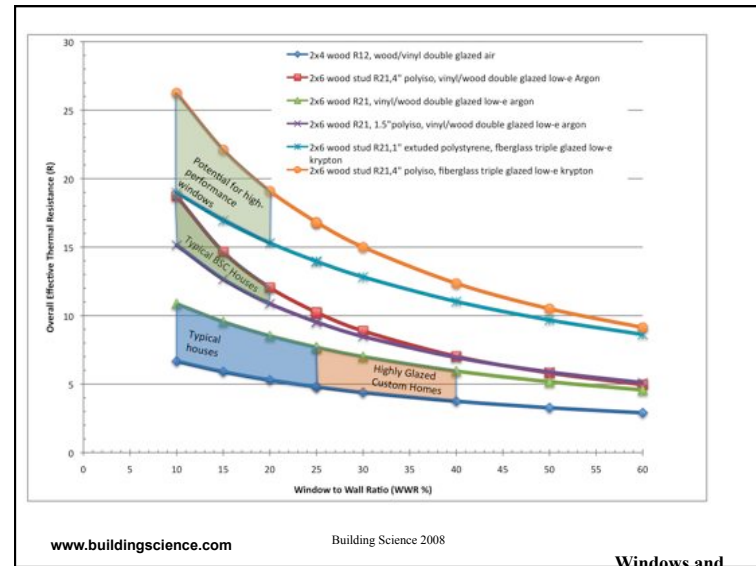
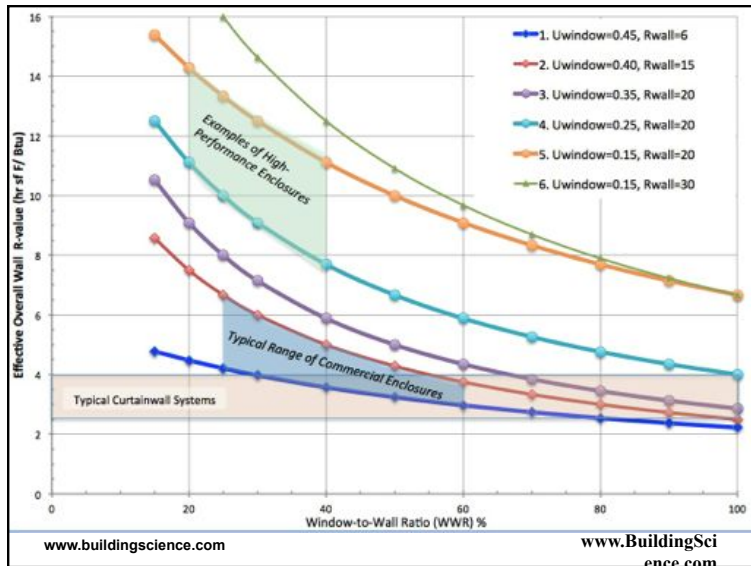

Solar Heat Gain Control

www.buildingscience.com

Solar Control and Shading

- Solar Control Glass
- Fixed exterior
- Operable Exterior
- Operable interior

www.buildingscience.com

165

Solar Heat Gain

- SHGC = Ratio of Solar Incident to Heat Gain within Building

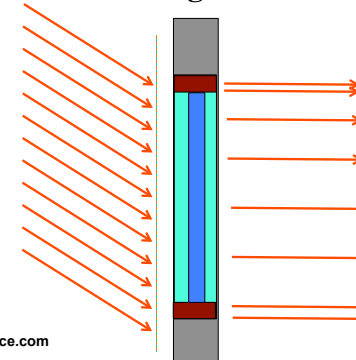

www.buildingscience.com

166

Solar Gain

- Solar gain useful during cold sunny weather
- But ... least heating is needed during daytime for commercial buildings
- Overheating discomfort is a real risk
- Must size glass Area x SHGC carefully
 - High values = air conditioning and discomfort

www.buildingscience.com

www.BuildingScience.com

Impact of Angle

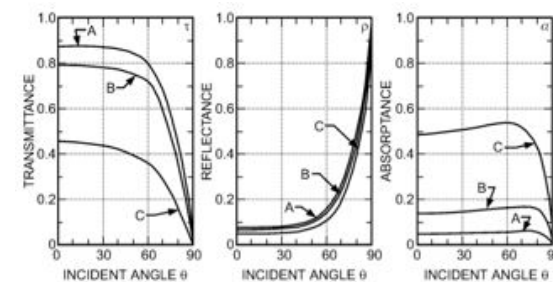

Fig. 8 Variations with Incident Angle of Solar-Optical Properties for (A) Double-Strength Sheet Glass, (B) Clear Plate Glass, and (C) Heat-Absorbing Plate Glass

www.buildingscience.com

168

Solar Properties

Table 10 Visible Transmittance (T_v), Solar Heat Gain Coefficient (SHGC), Solar Transmittance (T), Front Reflectance (R_f), Back Reflectance (R_b), and Layer Absorptance (A_L) for Glazing and Window Systems (Continued)

Glazing System	Center Glazing T_g	Center-of-Glazing Properties							Total Window SHGC at Normal Incidence				Total Window T_v at Normal Incidence					
		Normal	Incidence Angles						Aluminum		Other Frames		Aluminum		Other Frames			
			0.00	40.00	50.00	60.00	70.00	80.00	Hemisp. Diffuse	Operable	Fixed	Operable	Fixed	Operable	Fixed	Operable	Fixed	
<i>Low-e Double Glazing, e = 0.2 on surface 2</i>																		
17a 3	LE CLR	0.76	SHGC	0.65	0.64	0.61	0.56	0.43	0.23	0.57	0.59	0.60	0.53	0.58	0.68	0.68	0.61	0.67
			T	0.59	0.56	0.54	0.48	0.36	0.18	0.50								
			R_f	0.15	0.16	0.18	0.24	0.37	0.61	0.22								
			R_b	0.17	0.18	0.20	0.26	0.38	0.61	0.24								
			A_L	0.20	0.21	0.21	0.21	0.20	0.16	0.20								
			A_L	0.07	0.07	0.08	0.08	0.07	0.05	0.07								

www.buildingscience.com

169

Spectrally Selective

- Allows low SHGC and high VT
- Coolness Factor (LSG)
 - VT / SHGC
 - Look of 1.7-2.0
 - E.g. VT=0.60, SHGC=0.30, LSG=2

www.buildingscience.com

Building Science

Windows and

Solar Control Glazing

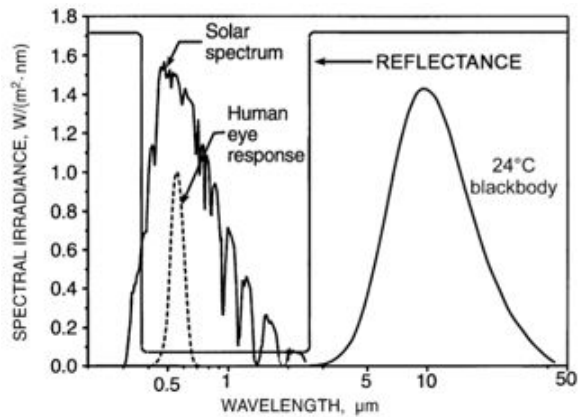

www.buildingscience.com

171





Fixed Shade

- Only work some of the time
- Allow all diffuse light in
 - This is good for daylight and view!
- Limits solar reduction to about 50-60%
- Often can get shoulder season over heating

www.buildingscience.com

174

Solar Gains - July 21 @45 N

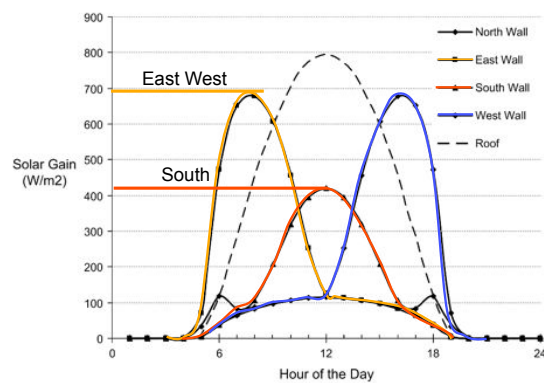

www.buildingscience.com

Building Science 2008

Windows and Curtainwalls

Mother Nature is try to tell you something

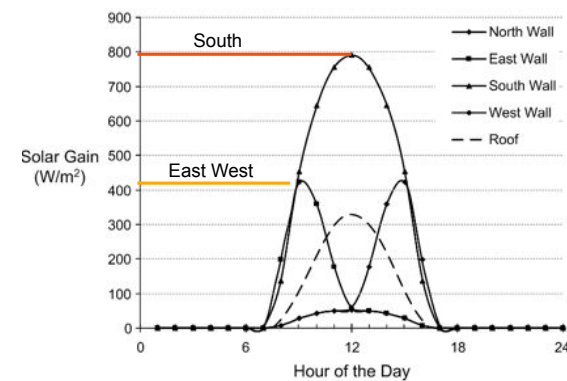

www.buildingscience.com

Building Science 2008

Windows and Curtainwalls

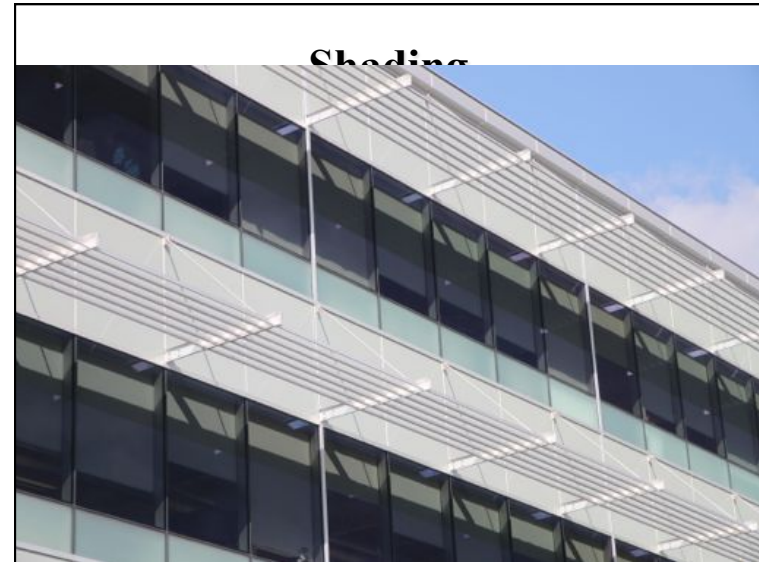
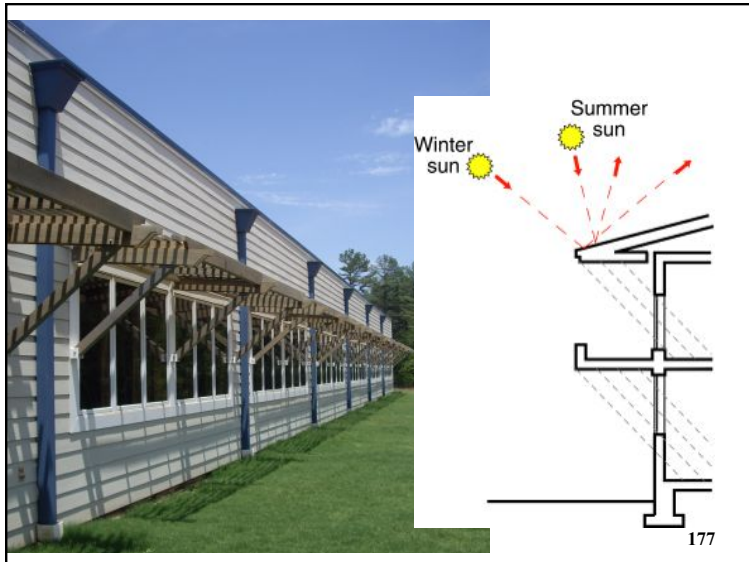

Interior or Exterior Shade

- Operable Solar Control of windows may be necessary for ultra-low energy buildings
- Exterior Shades always beat low SHGC glazing
 - But increased cost capital and maintenance
- Interior shades don't work well with good windows

The diagram shows two window cross-sections. The left window has 13% solar radiation entering from the top. 6% is blocked by the window frame, leaving 27% (13% + 14%) entering the room. 27% is blocked by an interior shade, leaving 0% entering the room. The right window has 17% solar radiation entering from the top. 16% is blocked by an exterior shade, leaving 1% entering the room. 14% is blocked by an interior shade, leaving 5% entering the room. The total solar radiation entering the room is 0% for the interior shade and 14% for the exterior shade.

www.buildingsci

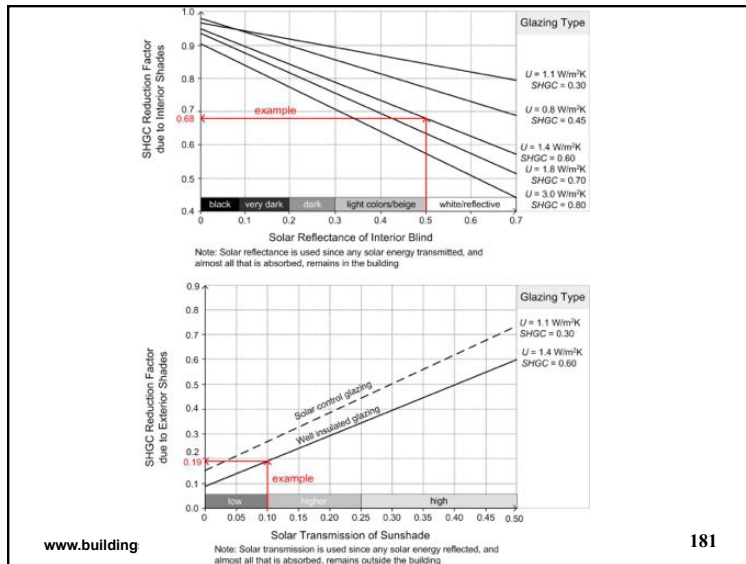

Using Vision 5.0 (U of Waterloo)

Solar Control + shades

Double Glazing Results Gas fill is 90% Ar
SB70XL Strph-6 (5439) & Clear_6.PPG (5012), Low-e 2

Case	Measure	0	rb	vb30	vb60	vb85
Summer	Interior U-Value	4.3	4.9	4.9	4.9	4.9
	Shade SHGC	0.27	0.2	0.24	0.2	0.16
	Exterior U-Value	4.3	5.0	4.9	5.1	5.3
	Shade SHGC	0.27	0.13	0.2	0.07	0.02
	Between U-Value	4.3	6.0	6.9	7.6	8.2
Between SHGC	0.27	0.16	0.23	0.16	0.11	
Winter	Interior U-Value	4.2	5.1	5.0	5.2	5.4
	Shade SHGC	0.27	0.19	0.23	0.19	0.16
	Exterior U-Value	4.2	5.5	5.5	5.6	5.6
	Shade SHGC	0.27	0.13	0.2	0.07	0.02
	Between U-Value	4.2	4.3	4.4	4.3	4.3
Between SHGC	0.27	0.15	0.22	0.15	0.09	

Triple Glazing Results Gas fill is 90% Ar
SB70XL Strph-6 (5439), LoE272-6, CIG (2014), Clear_6.PPG (5012), Low-e 2 & 4

Case	Measure	0	rb	vb30	vb60	vb85
Summer	Interior U-Value	7.2	7.7	7.7	7.7	7.7
	Shade SHGC	0.18	0.15	0.16	0.15	0.13
	Exterior U-Value	7.2	8.0	7.8	8.2	8.5
	Shade SHGC	0.18	0.09	0.13	0.05	0.01
	Between U-Value	7.2	7.5	7.0	6.9	7.2
Between SHGC	0.18	0.11	0.15	0.1	0.06	
Winter	Interior U-Value	8.1	9.0	8.9	9.0	9.3
	Shade SHGC	0.18	0.15	0.16	0.15	0.13
	Exterior U-Value	8.1	9.5	9.3	9.5	9.5
	Shade SHGC	0.18	0.09	0.14	0.05	0.01
	Between U-Value	8.1	8.4	8.4	8.4	8.4
Between SHGC	0.18	0.11	0.14	0.1	0.06	

www.buildingscience.com 182

