

Joseph Lstiburek, Ph.D., P.Eng., ASHRAE Fellow

Stuck on You

Building Science Corporation

The Perfect Wall

2

- Water Control Layer
- Air Control Layer
- Vapor Control Layer
- Thermal Control Layer

3

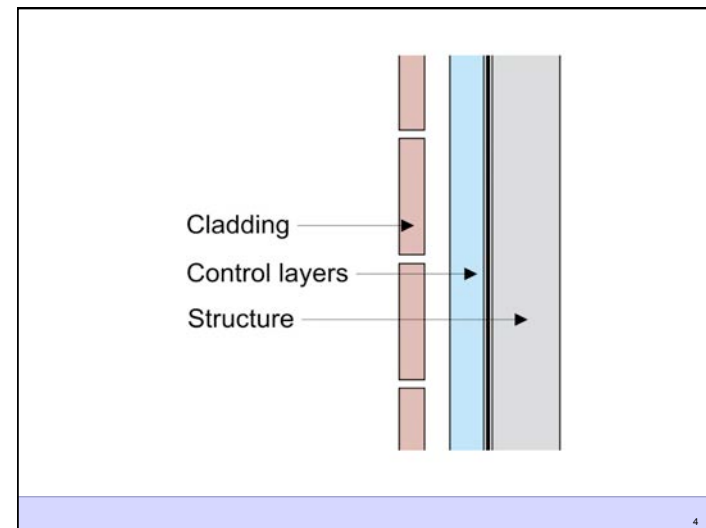

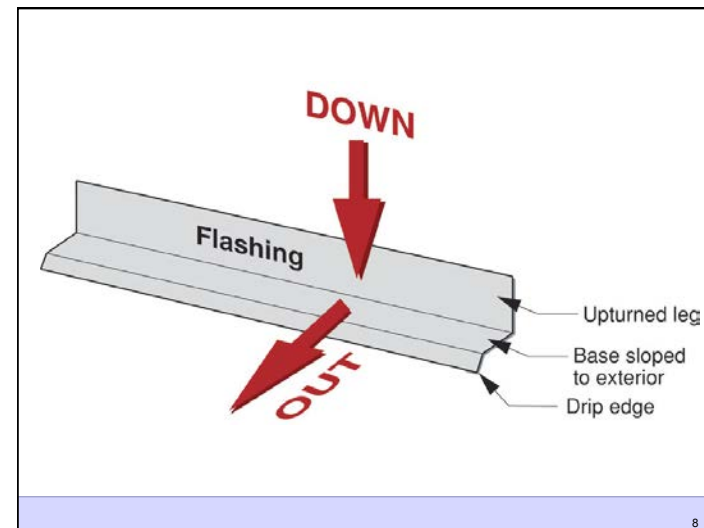
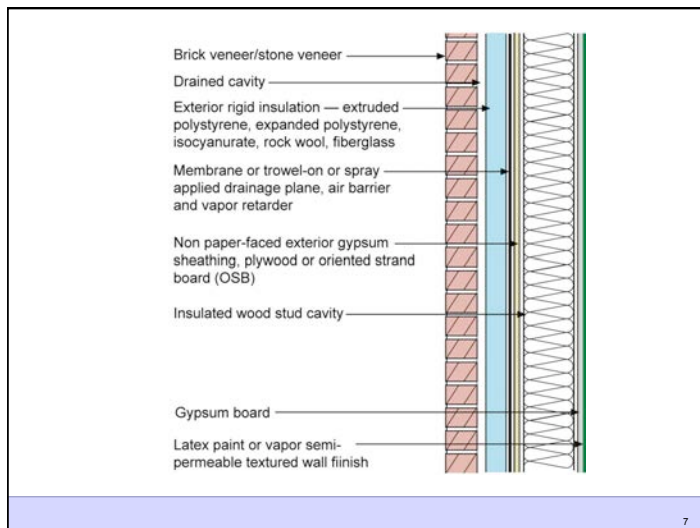
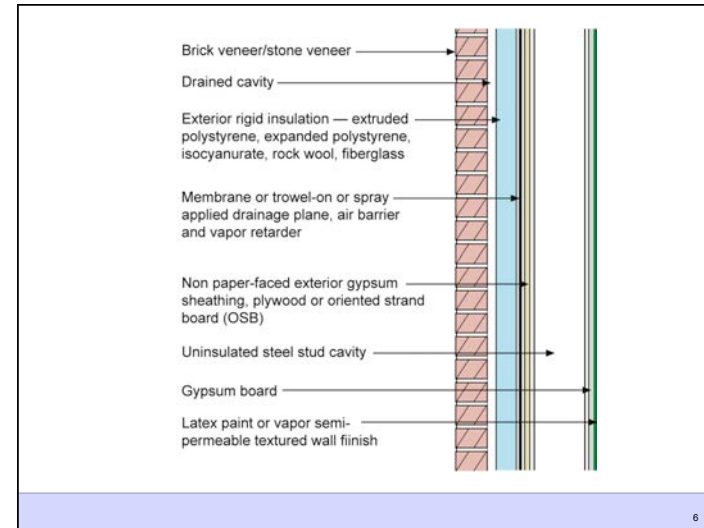
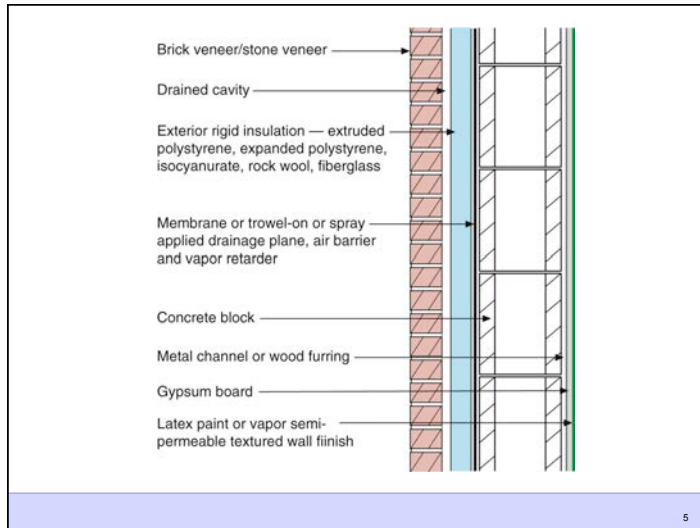

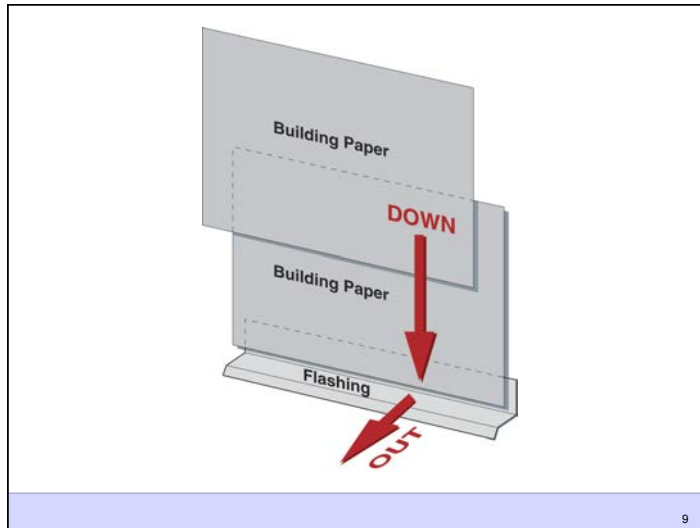

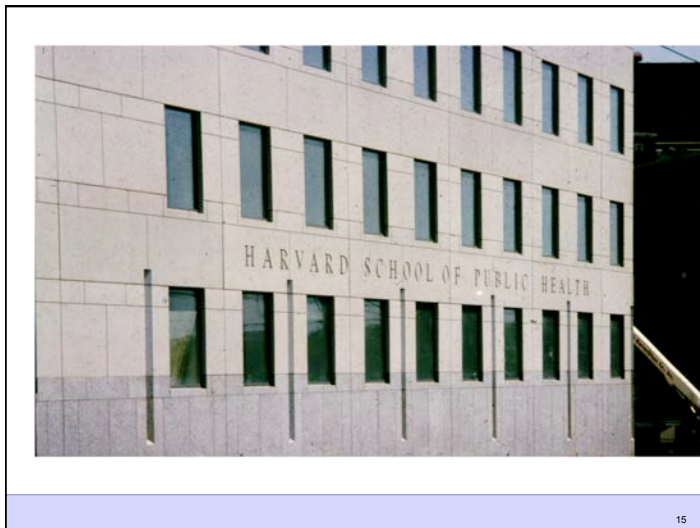
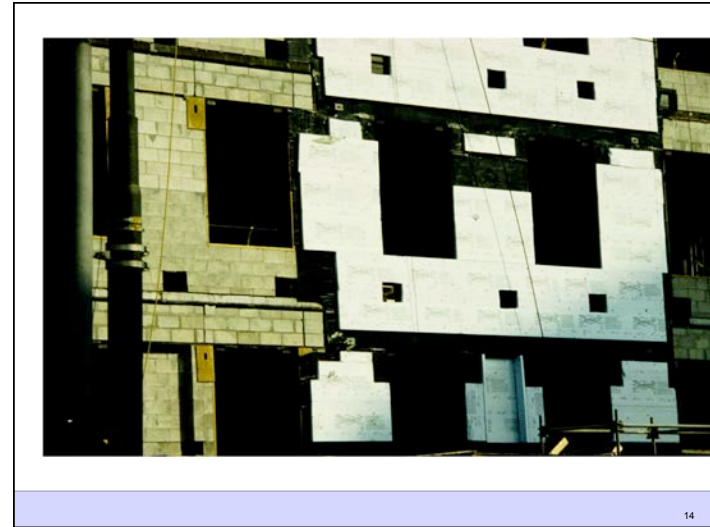

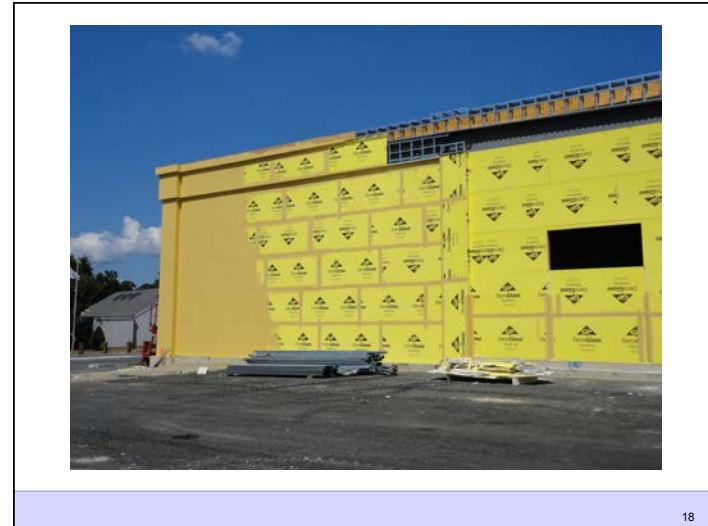
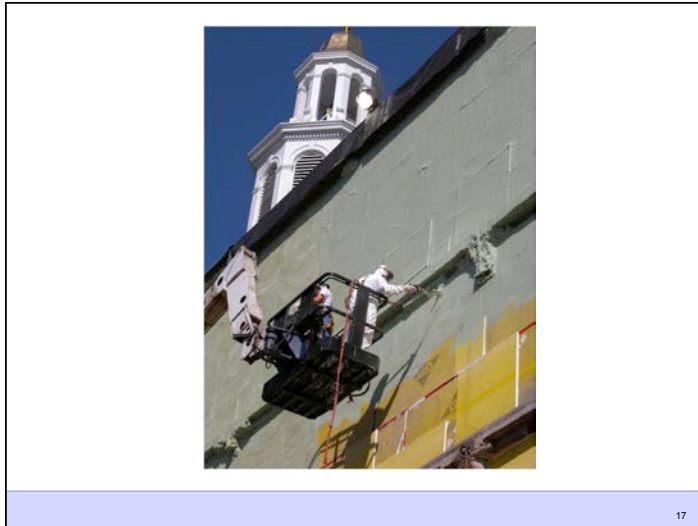

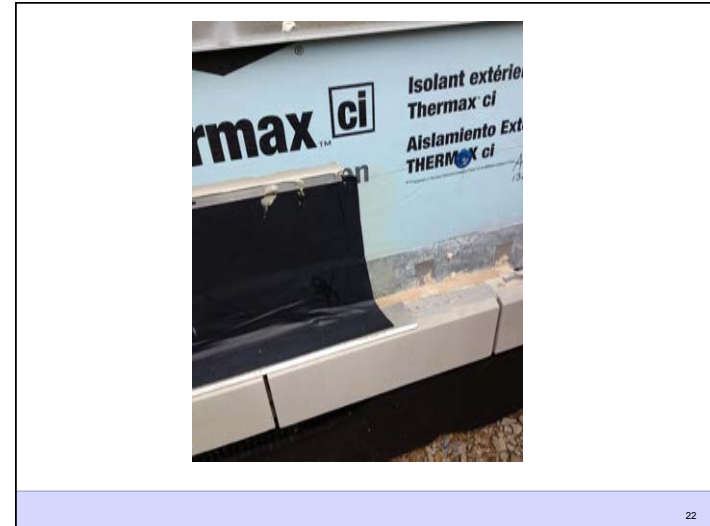
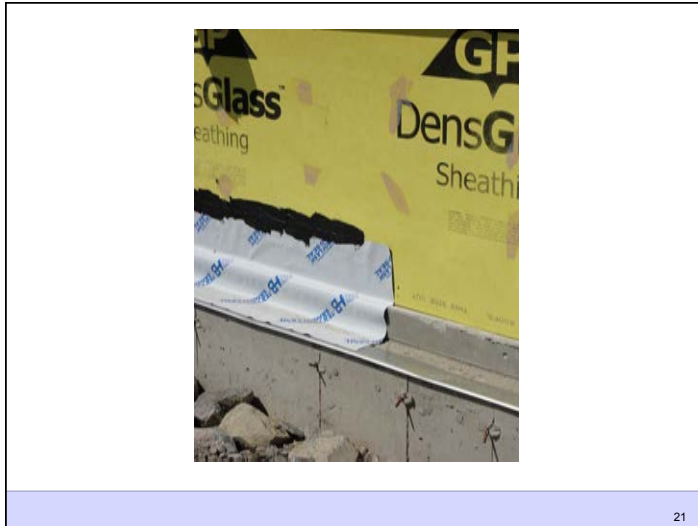

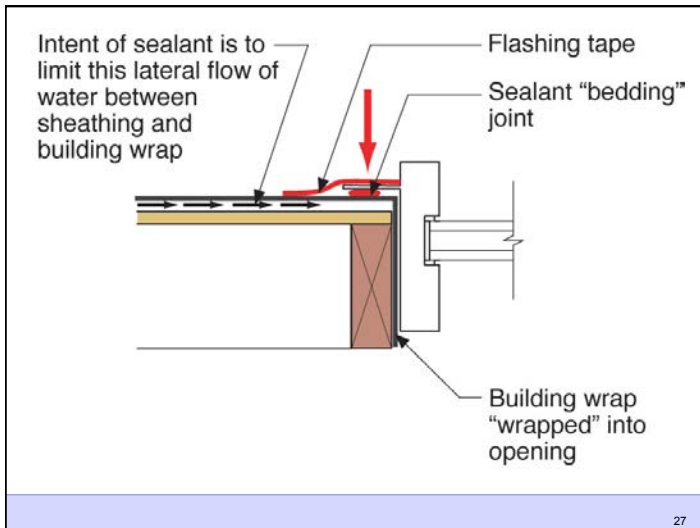
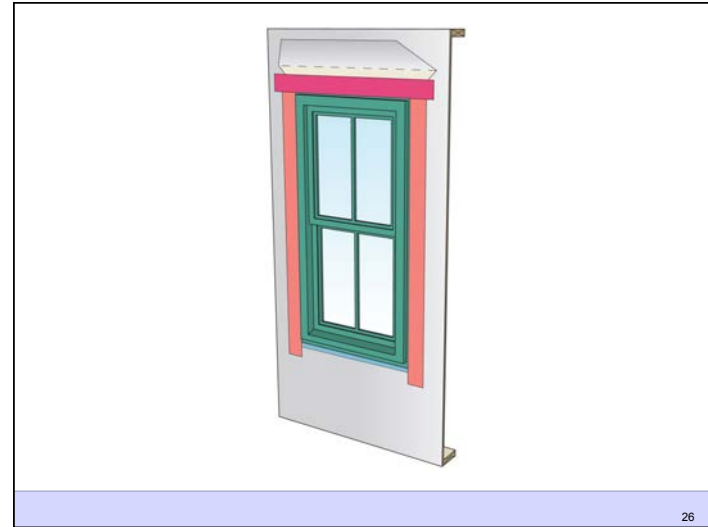







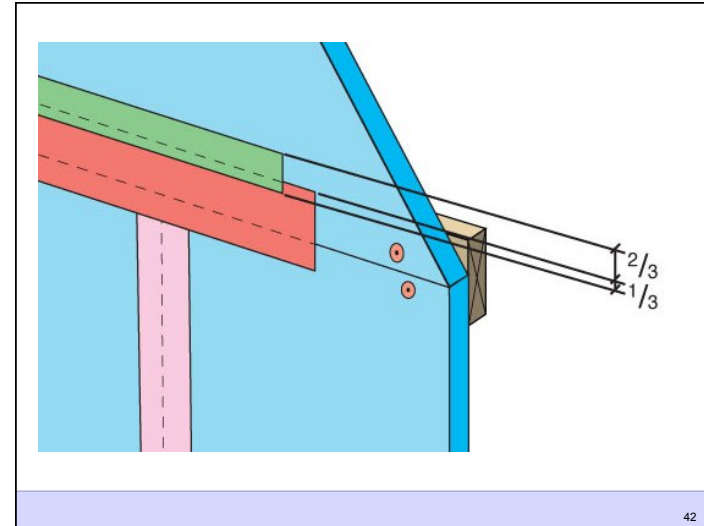

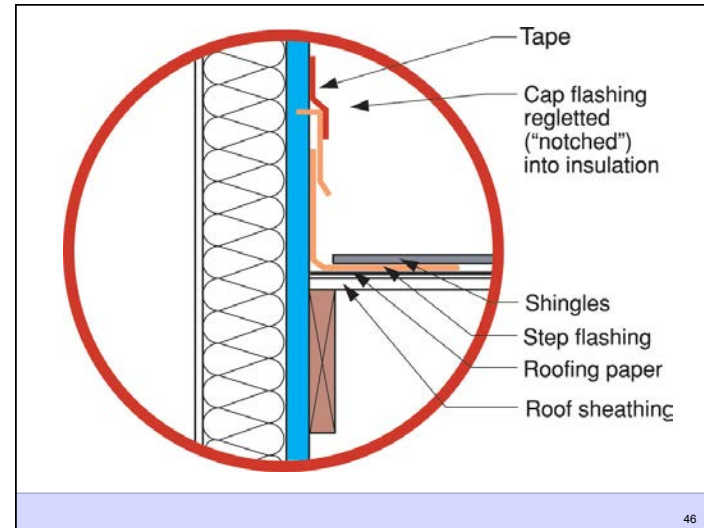

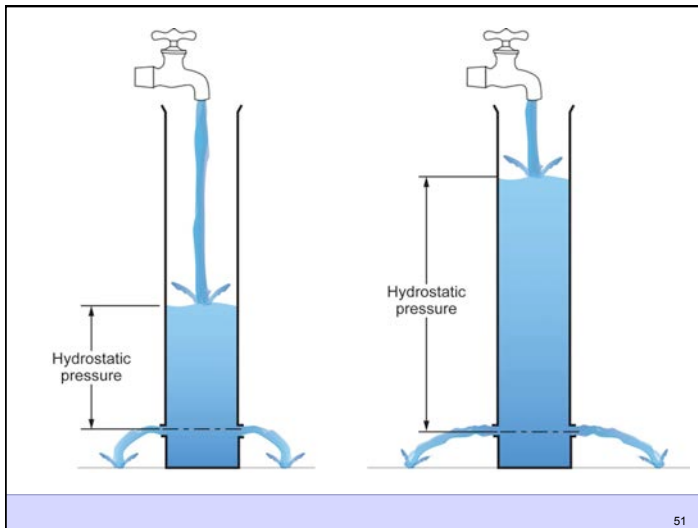
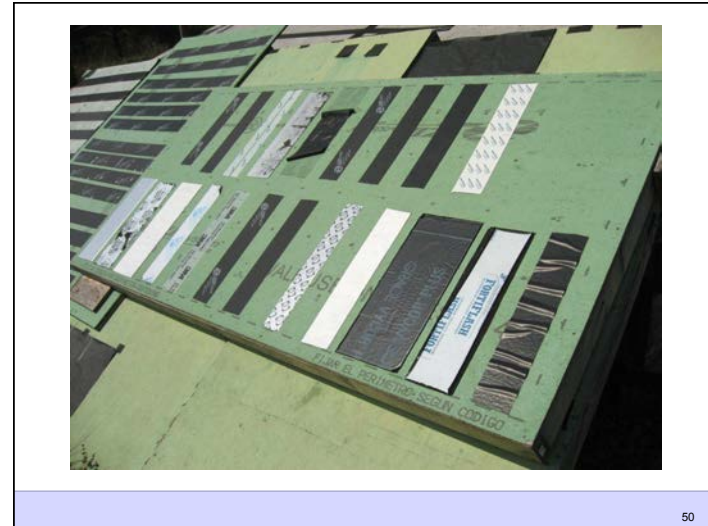

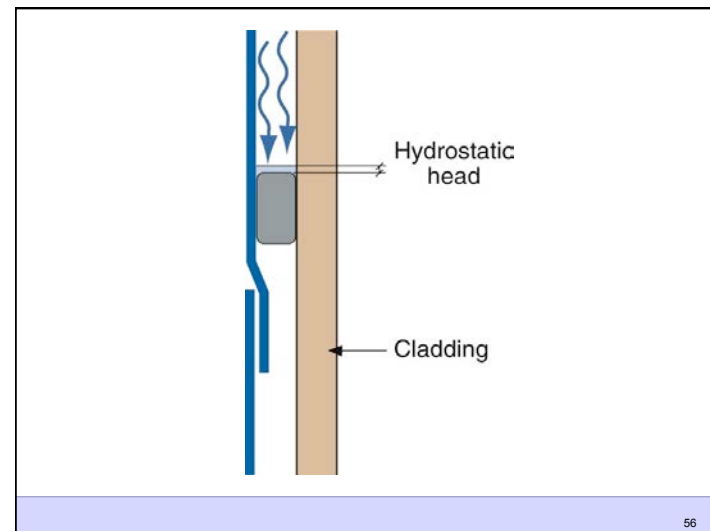
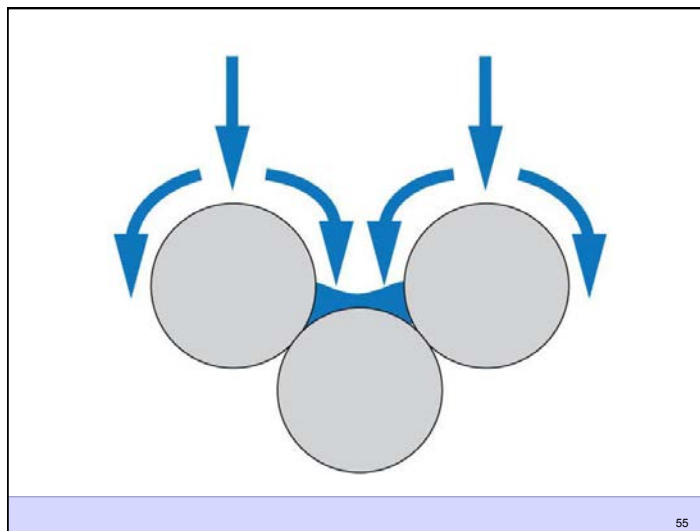
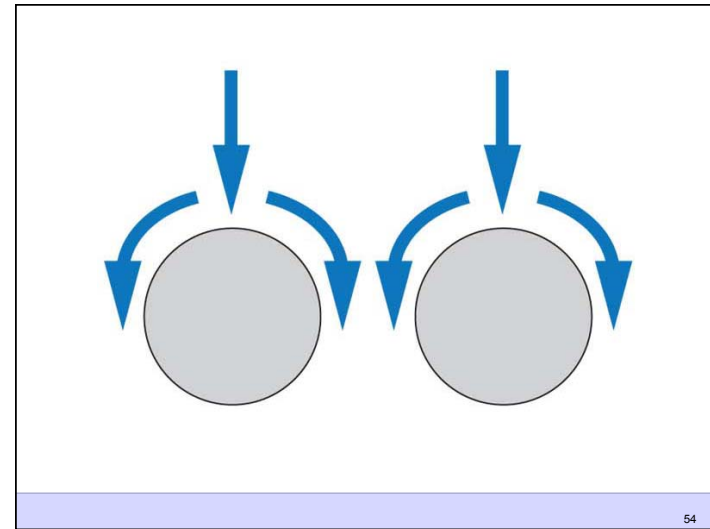
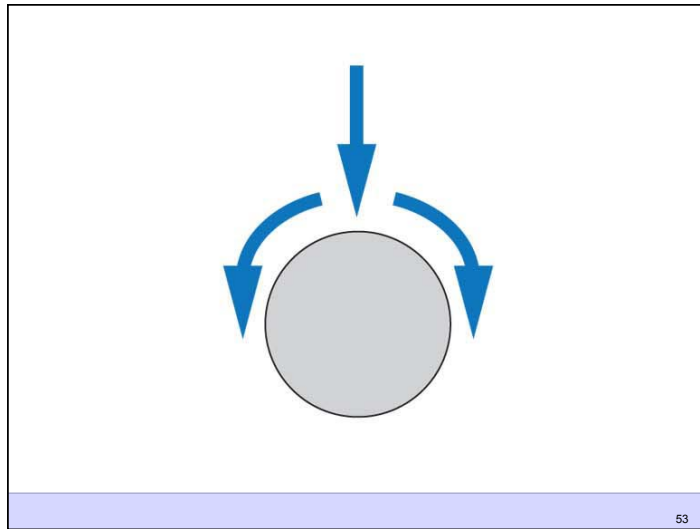

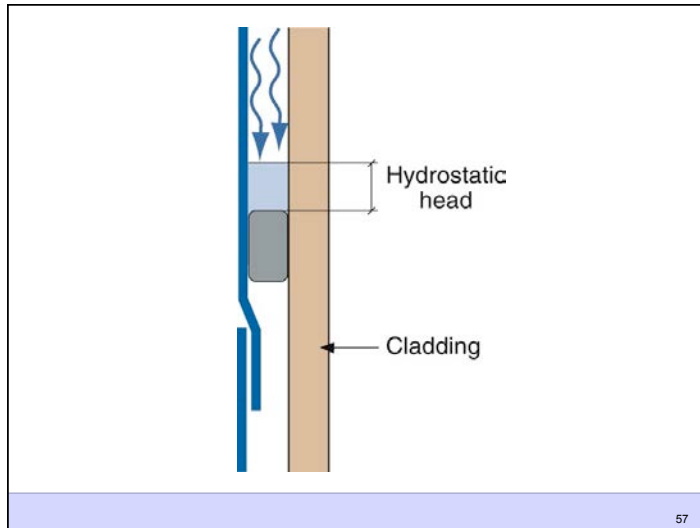

57

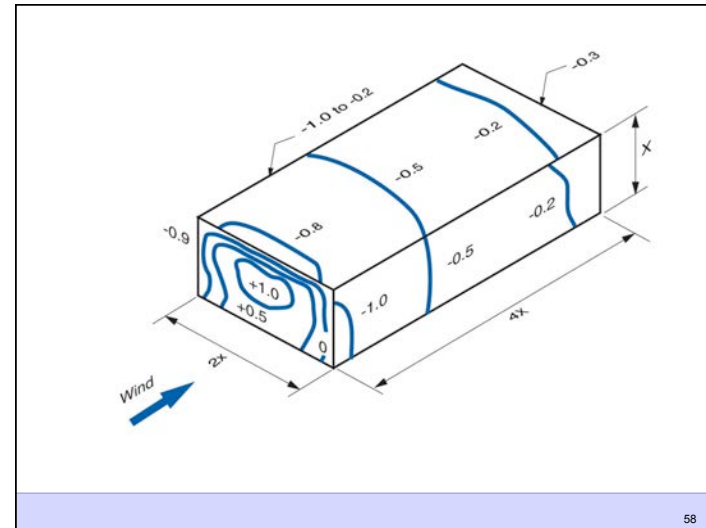

58

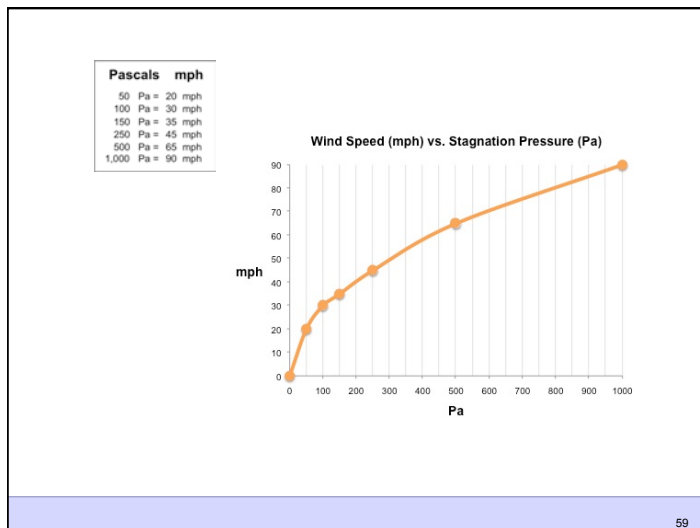

59



60



61



62



63

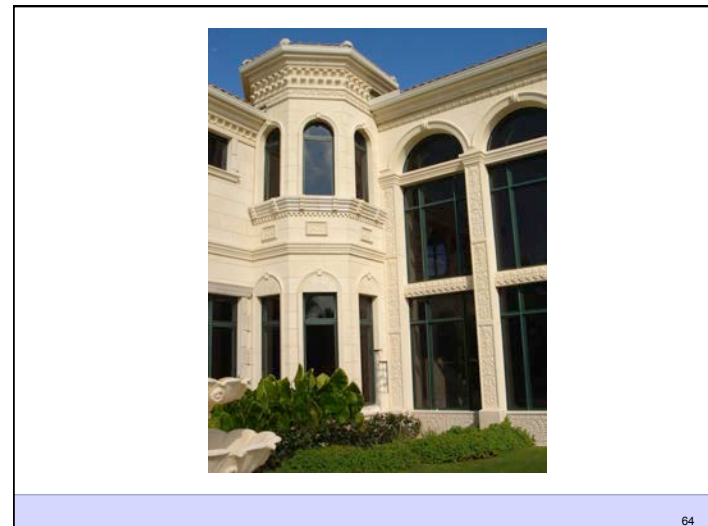

64

