

Joseph Lstiburek, Ph.D., P.Eng, ASHRAE Fellow

Building Science

Adventures In Building Science

www.buildingscience.com

Life is Tough Enough As it Is...

Building Science Corporation

Joseph Lstiburek 2

Life is Tough Enough As it Is...
It's Harder When You Are Stupid

Building Science Corporation

Joseph Lstiburek 3

Don't Do Stupid Things

Building Science Corporation

Joseph Lstiburek 4

Buildings Get Wet From The Outside
Buildings Get Wet From The Inside
Buildings Start Out Wet
Wet Happens

Building Science Corporation Joseph Lstiburek 5

Buildings Must Be Designed To Dry

Building Science Corporation Joseph Lstiburek 6

Buildings Can Dry To The Outside
Buildings Can Dry To The Inside
Buildings Can Dry To Both Sides

Building Science Corporation Joseph Lstiburek 7

2nd Law of Thermodynamics

Building Science Corporation Joseph Lstiburek 8

Heat Flow Is From Warm To Cold
 Moisture Flow Is From Warm To Cold
 Moisture Flow Is From More To Less
 Air Flow Is From A Higher Pressure to a
 Lower Pressure
 Gravity Acts Down

Building Science Corporation

Joseph Lstiburek 9



Building Science Corporation

Joseph Lstiburek 10

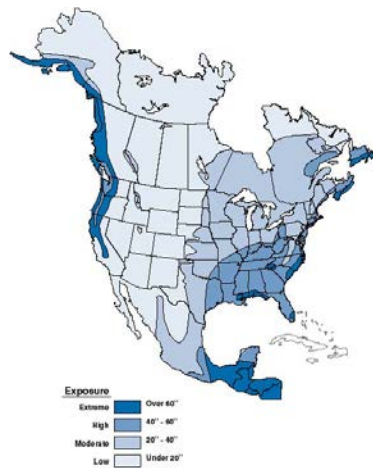

Building Science Corporation

Joseph Lstiburek 11

Don't Do Stupid Things

Building Science Corporation

Joseph Lstiburek 12

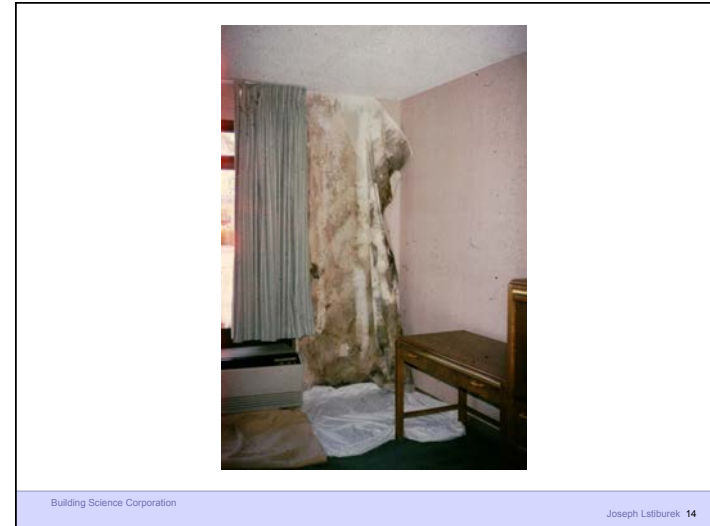



Building Science Corporation

Joseph Lstiburek 17

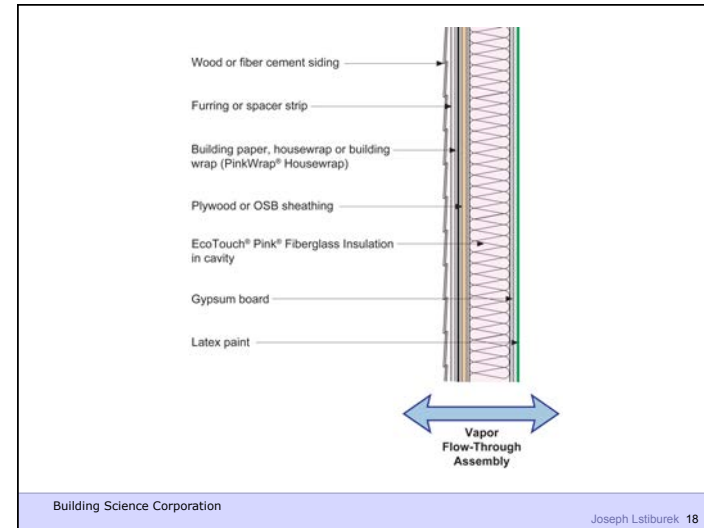

Building Science Corporation

Joseph Lstiburek 18

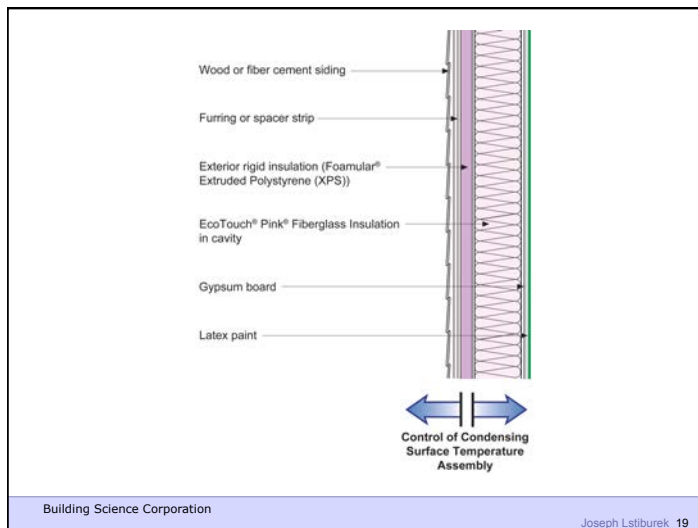

Building Science Corporation

Joseph Lstiburek 19

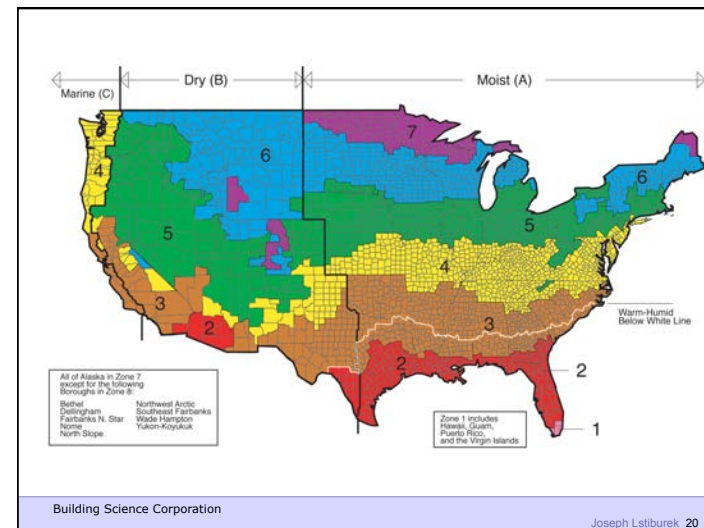

Building Science Corporation

Joseph Lstiburek 20

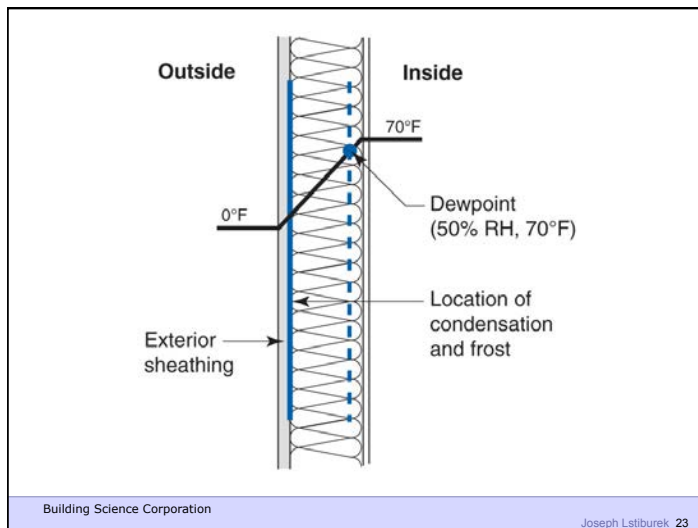
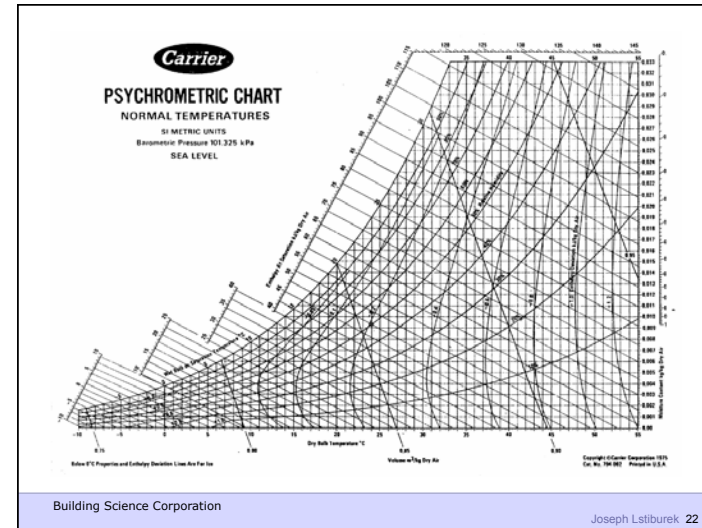
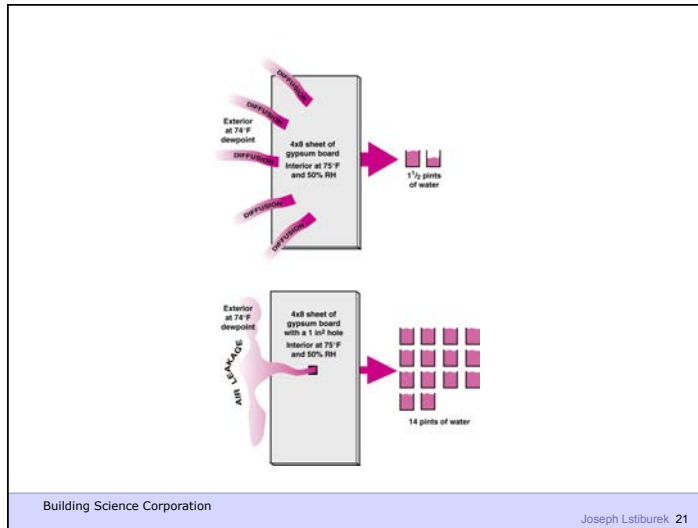

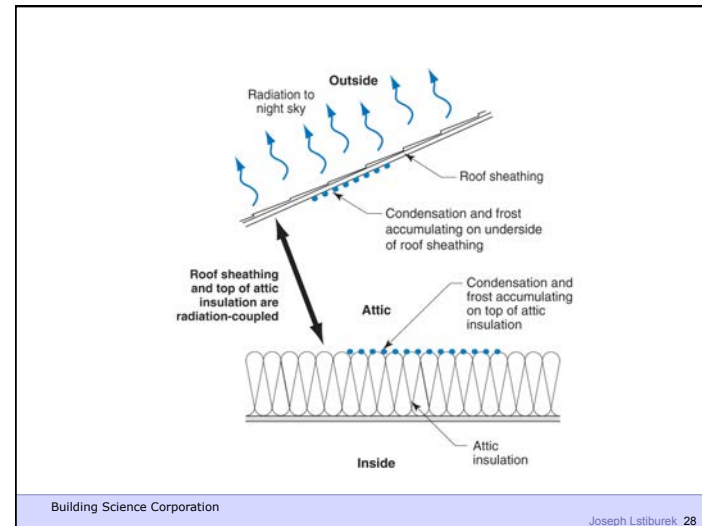
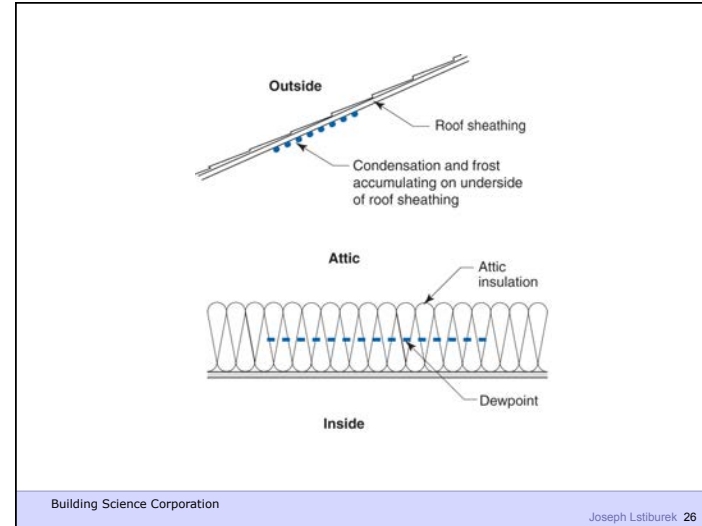
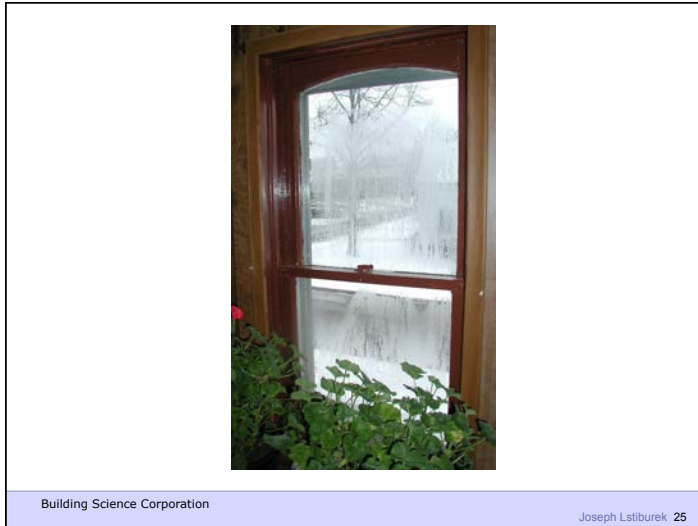



Building Science Corporation

Joseph Lstiburek 29



Building Science Corporation

Joseph Lstiburek 30

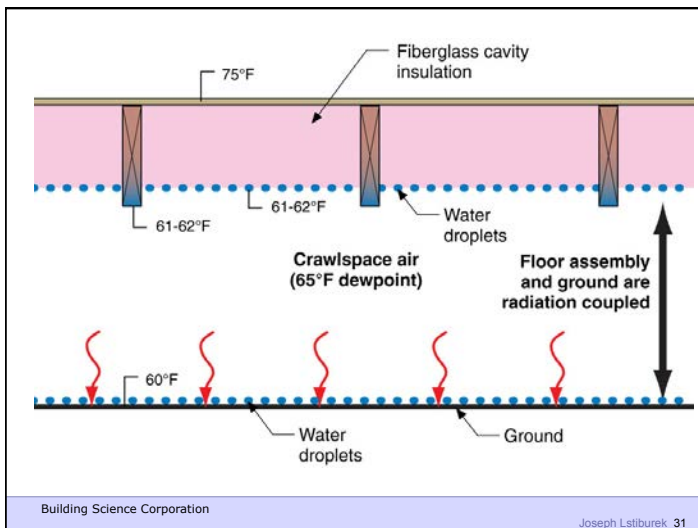

Building Science Corporation

Joseph Lstiburek 31

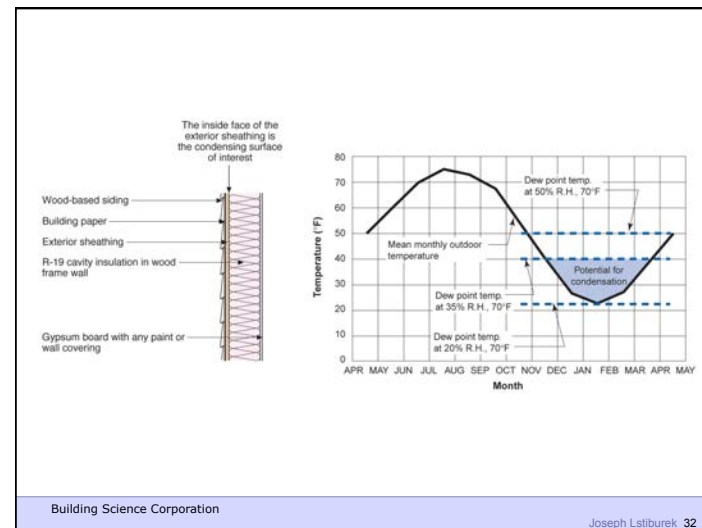

Building Science Corporation

Joseph Lstiburek 32

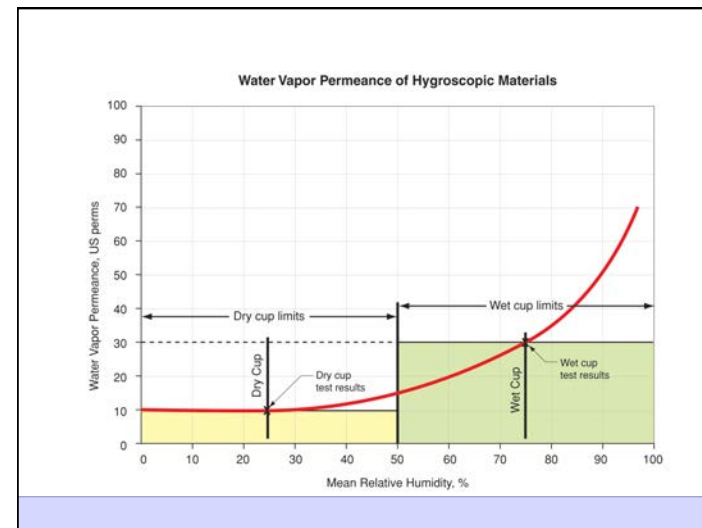
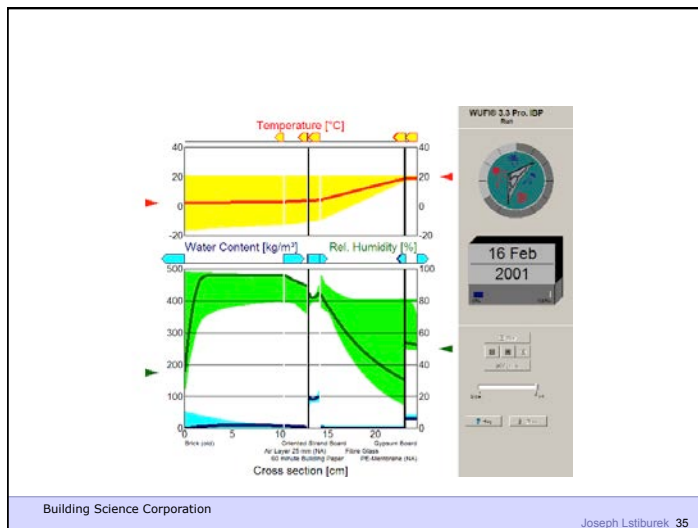
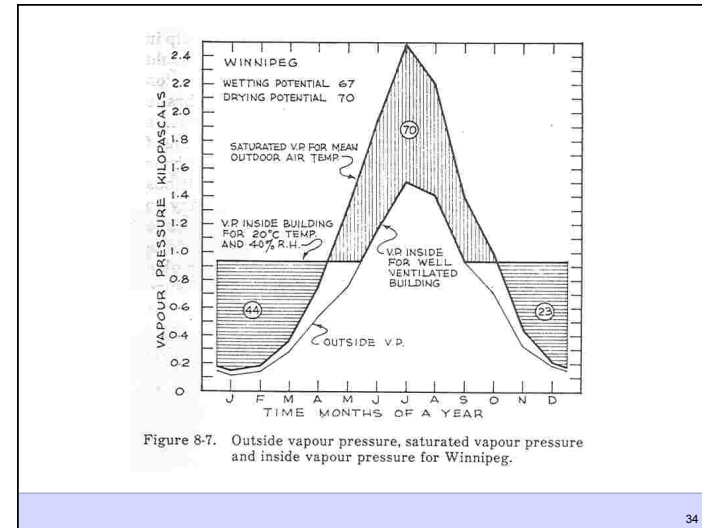
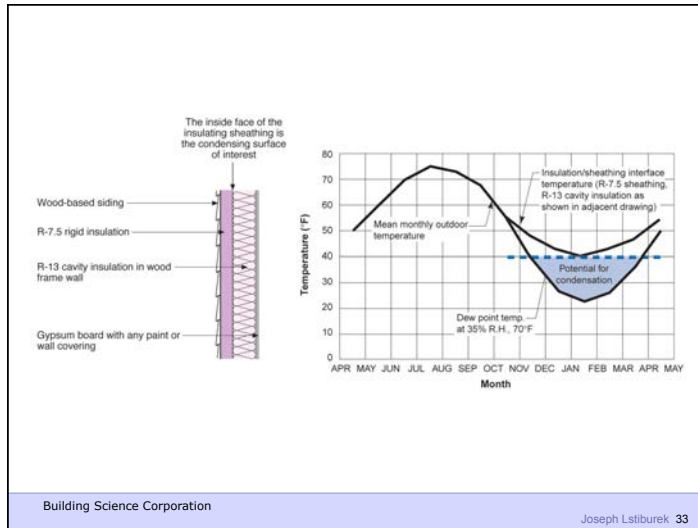

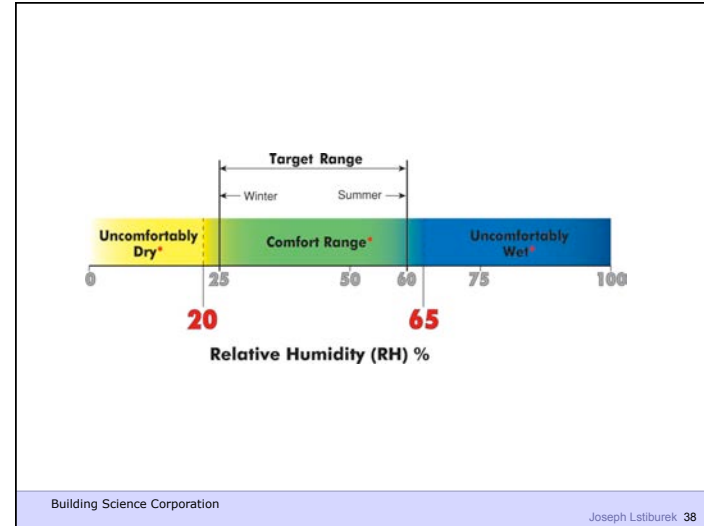

Building Science Corporation

Joseph Lstiburek 38

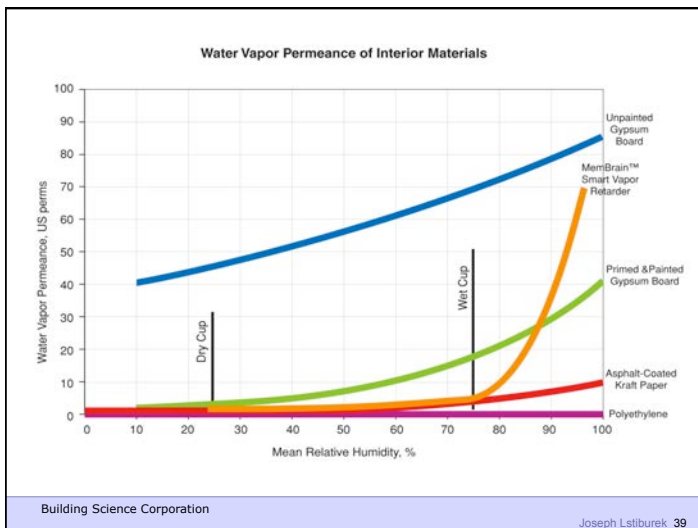

Building Science Corporation

Joseph Lstiburek 39

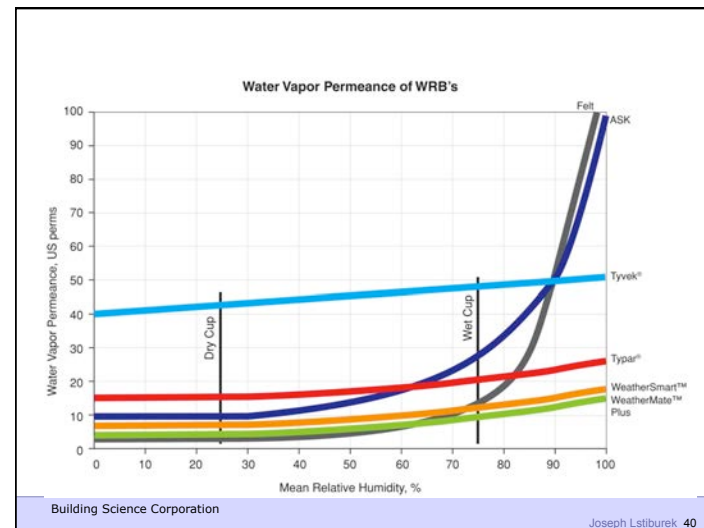

Building Science Corporation

Joseph Lstiburek 40

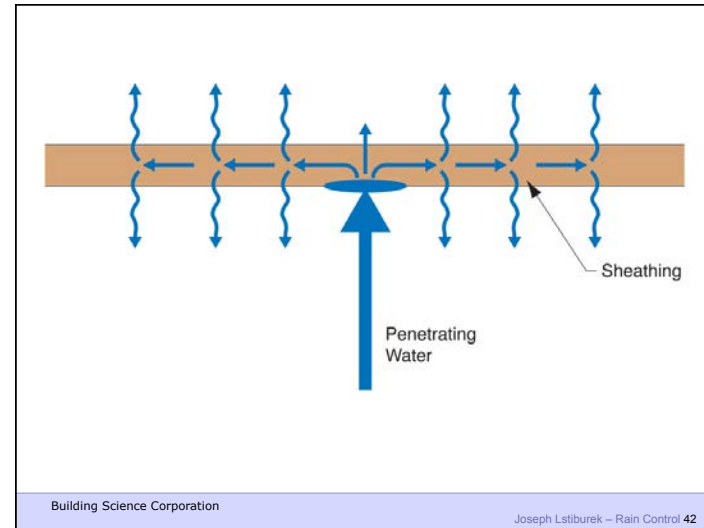
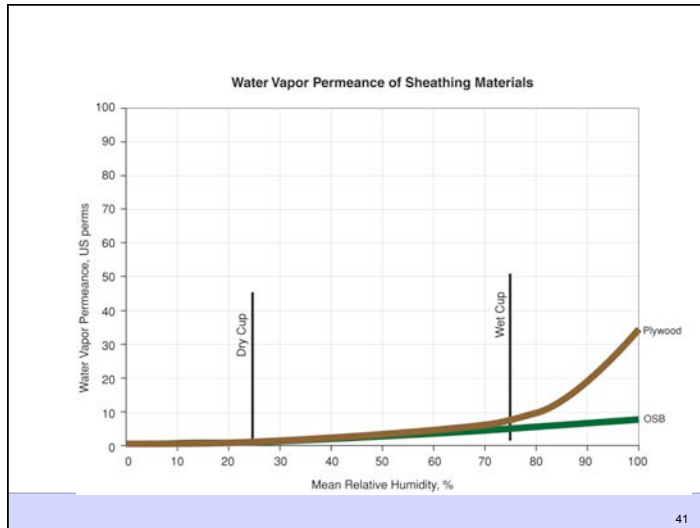

Building Science Corporation

Joseph Lstiburek – Rain Control 42

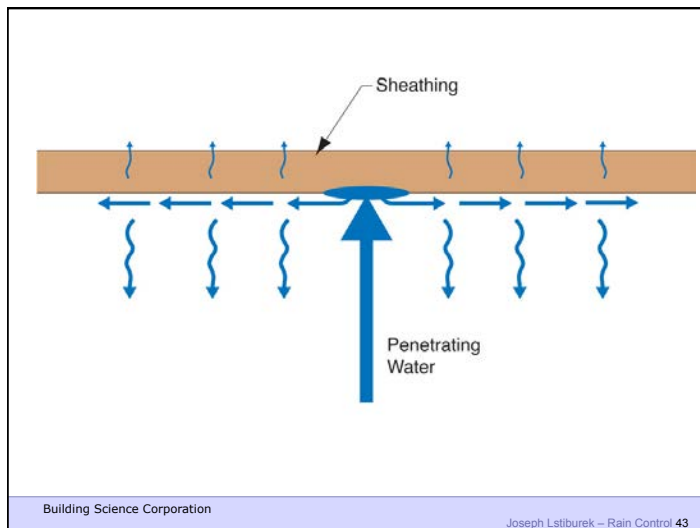

Building Science Corporation

Joseph Lstiburek – Rain Control 43



Building Science Corporation

Joseph Lstiburek – Rain Control 44

Rain Screen

Building Science Corporation Joseph Lstiburek 45

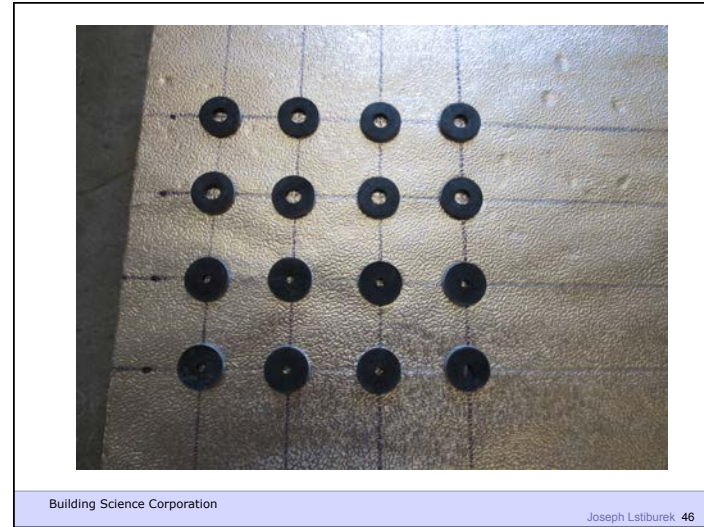

Beer Screen?

Building Science Corporation Joseph Lstiburek 47

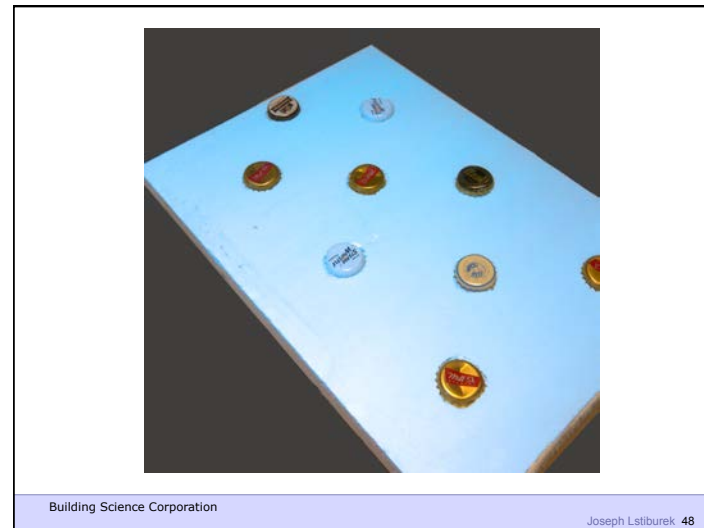

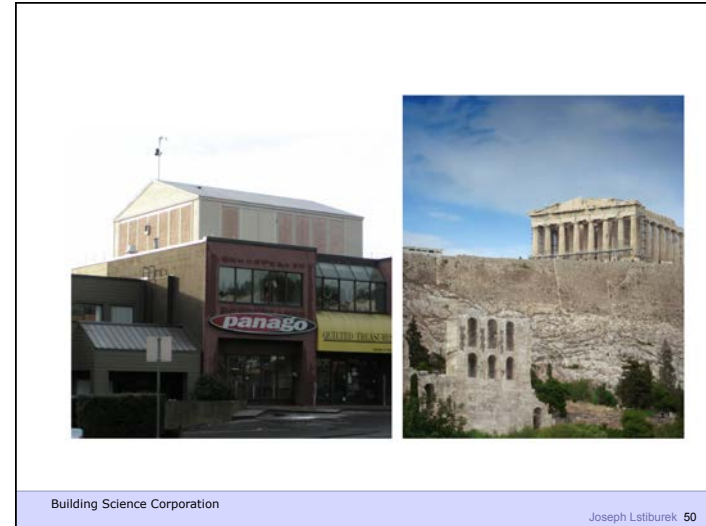
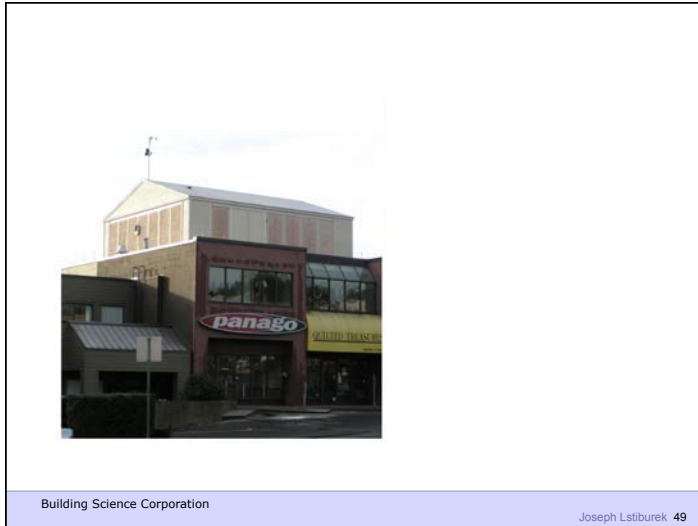



If You Need To Run A Hygrothermal Model
To Figure Out If Your Wall Works You
Have The Wrong Design

Building Science Corporation

Joseph Lstiburek 54

Water Control Layer
Air Control Layer
Vapor Control Layer
Thermal Control Layer

Building Science Corporation

Joseph Lstiburek 55

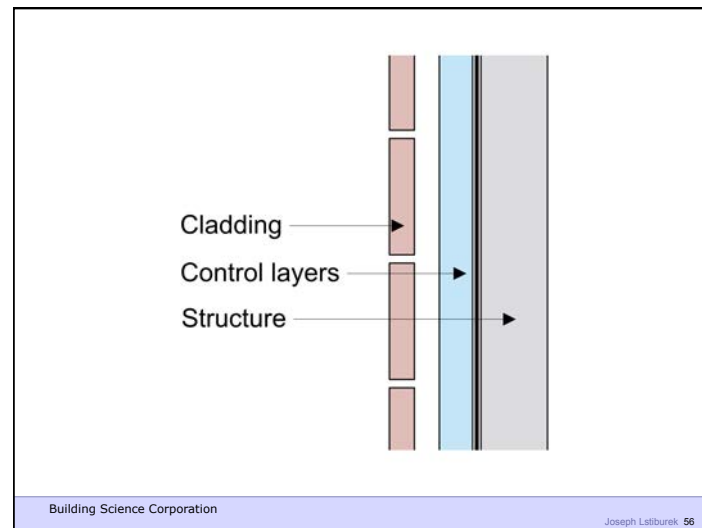

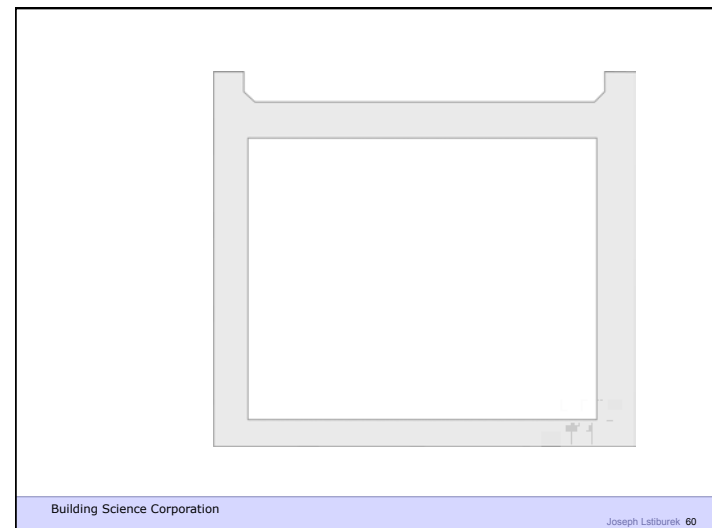
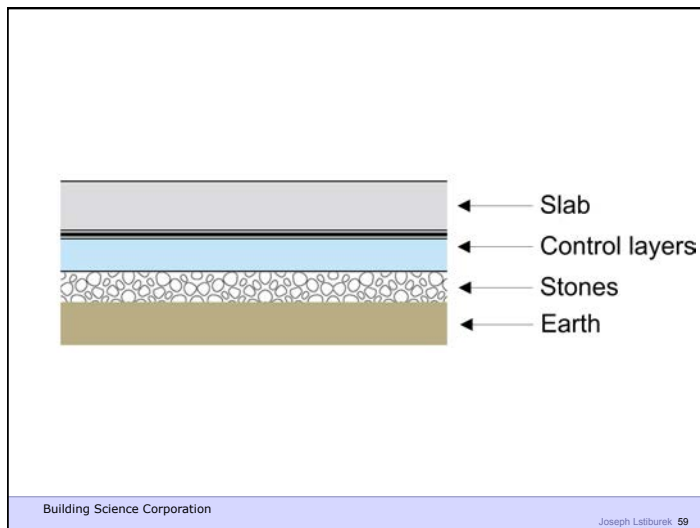
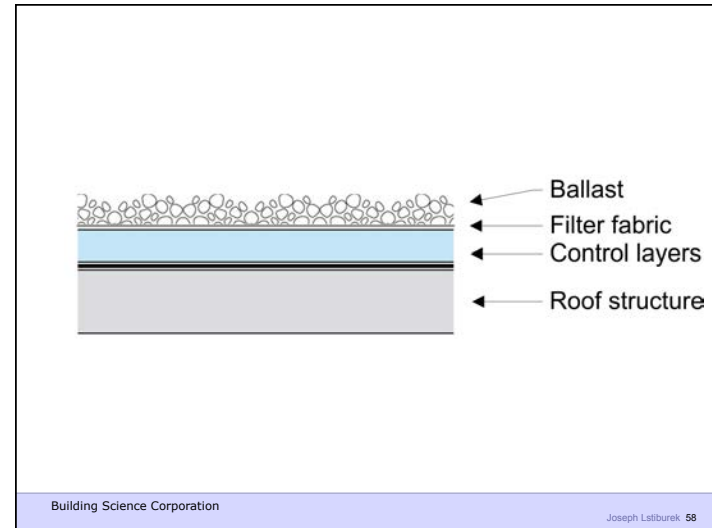
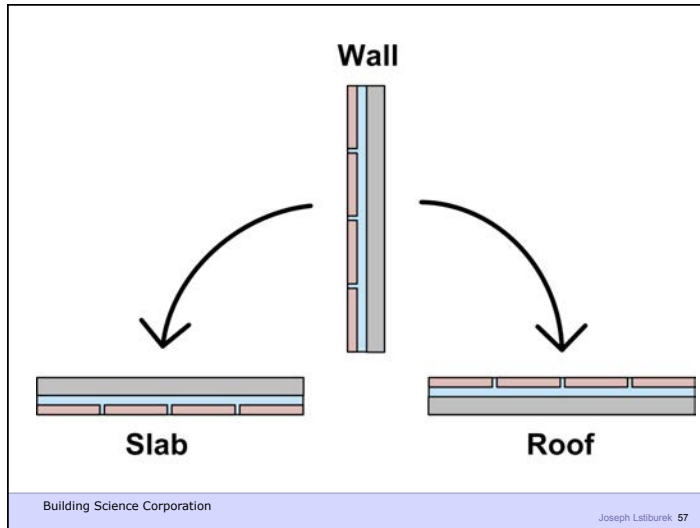

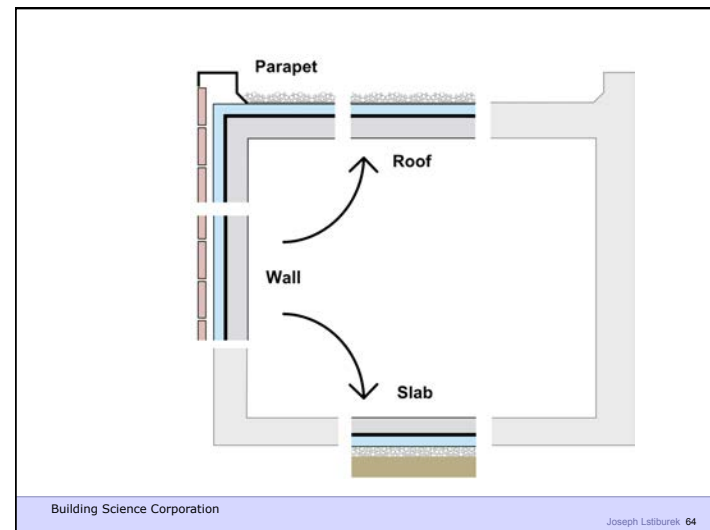
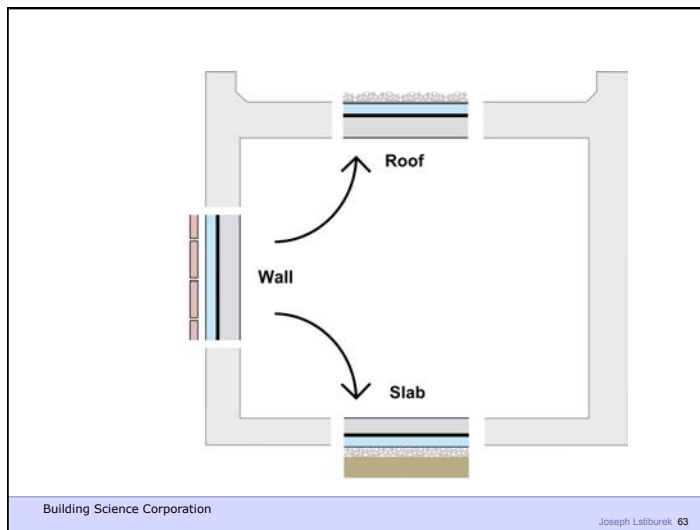
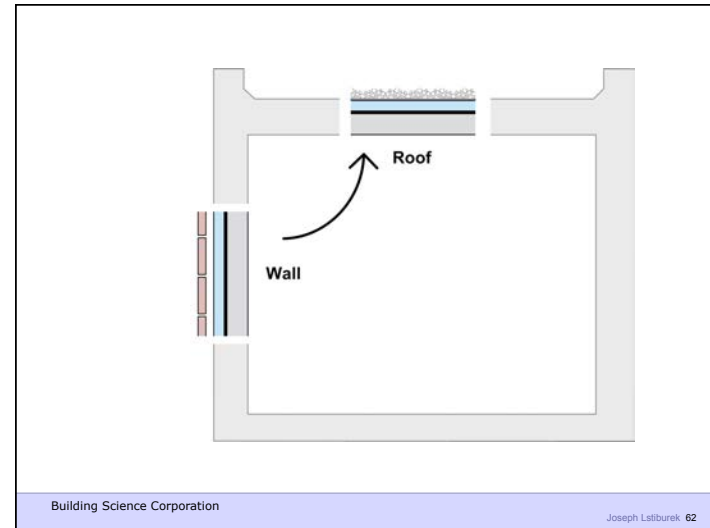
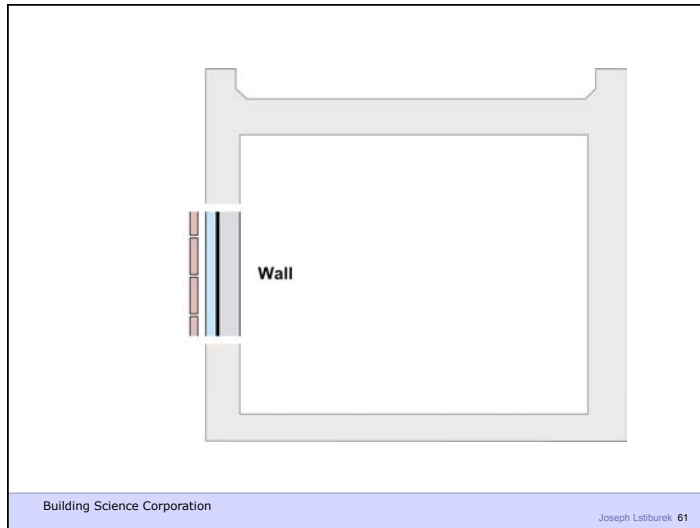

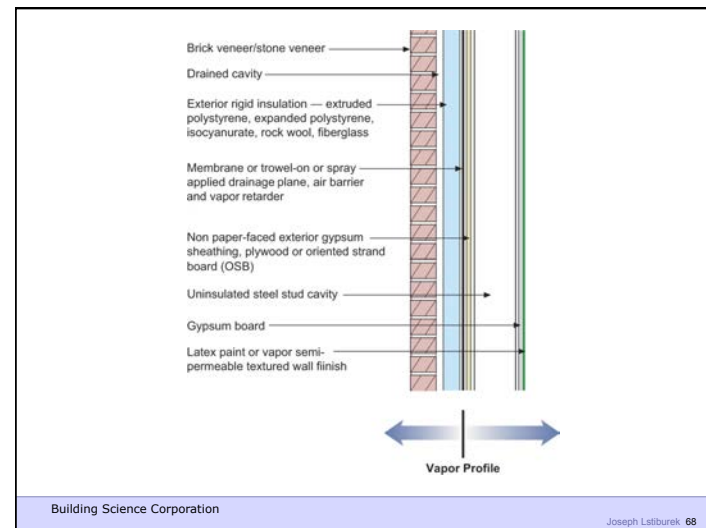
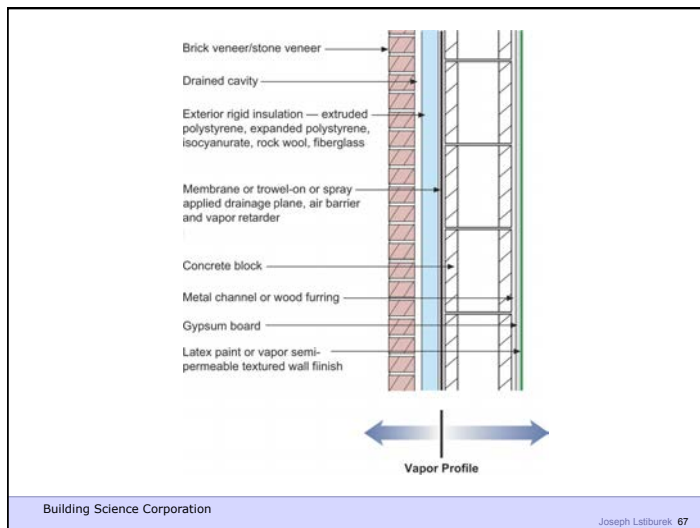
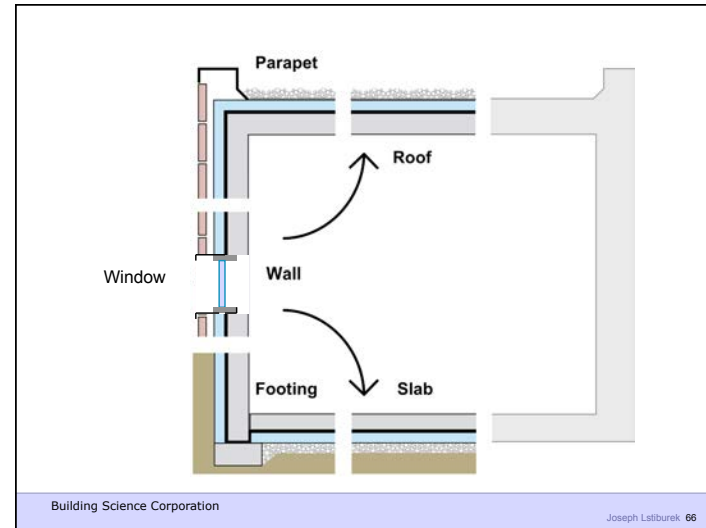
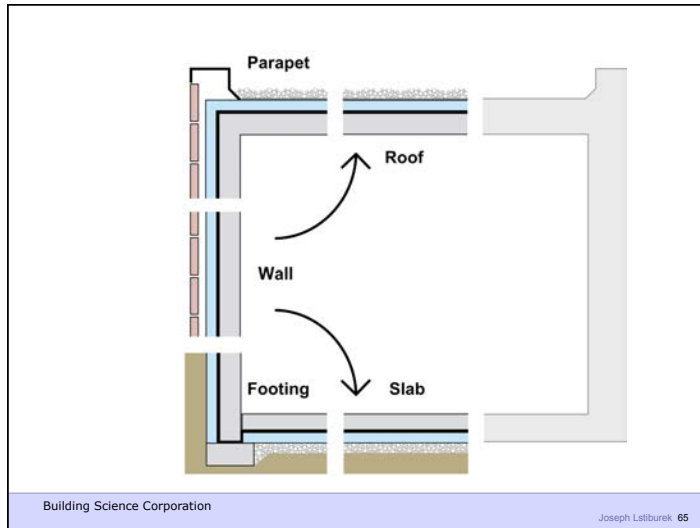

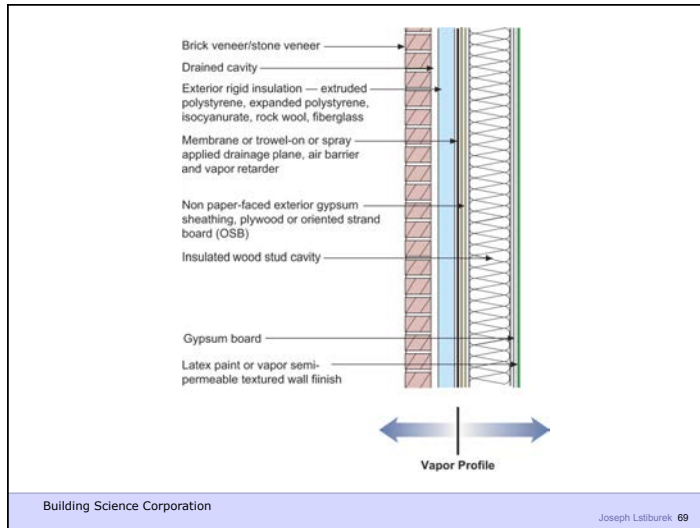

Commercial Enclosure: Simple Layers

- Structure
- Rain/Air/Vapor
- Insulation
- Finish

Building Science Corporation
 Joseph Lstiburek 70

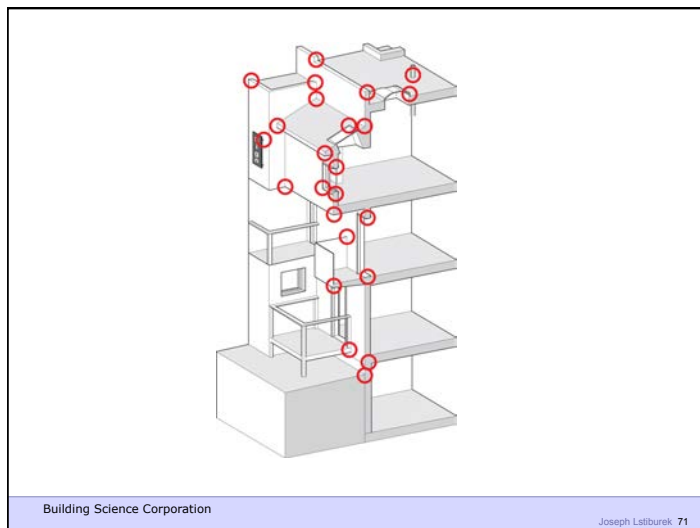

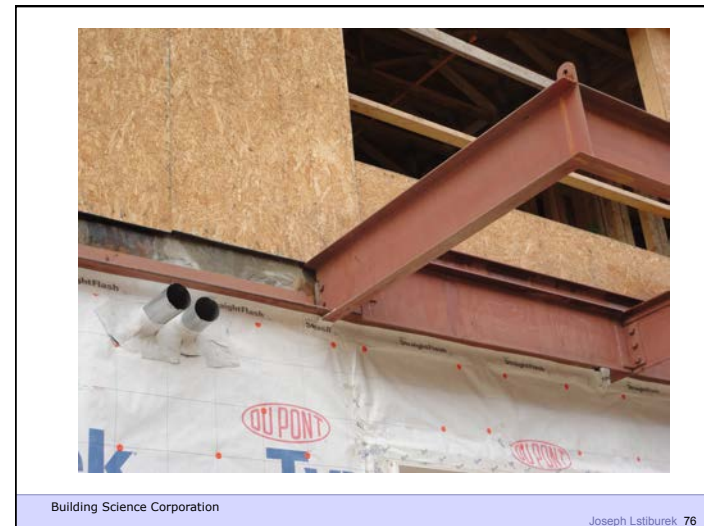
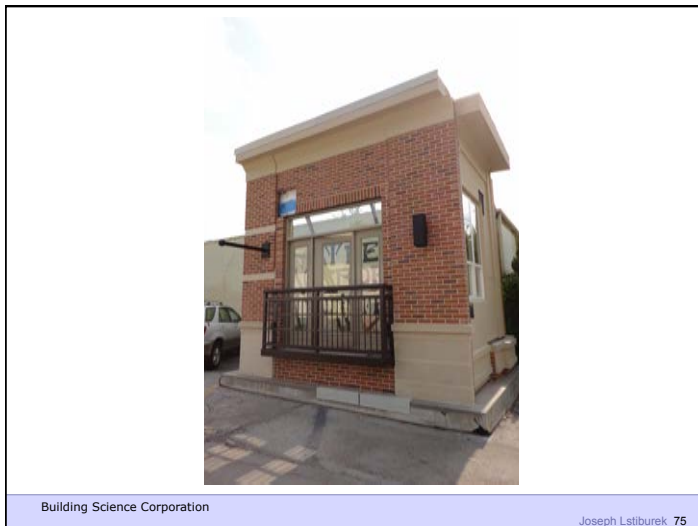

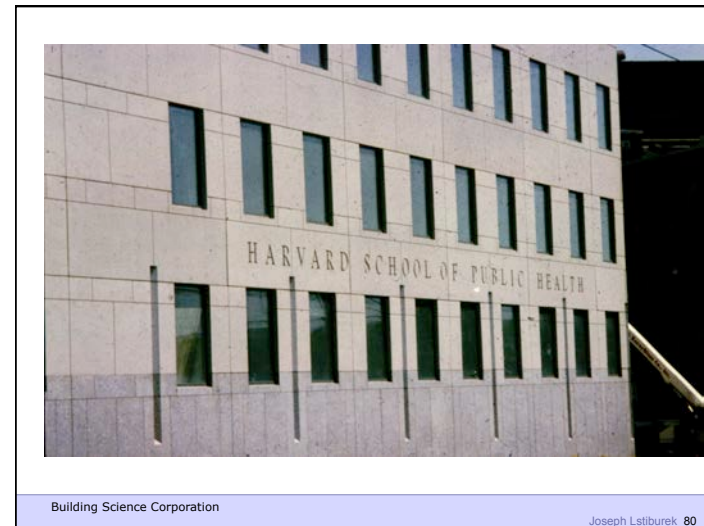
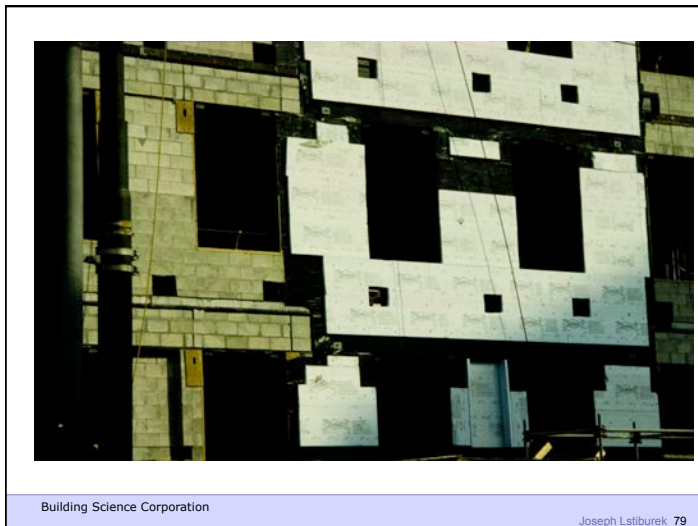

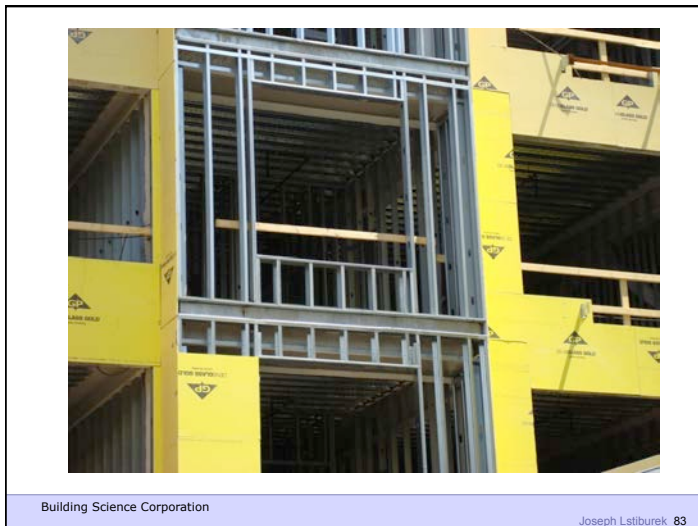

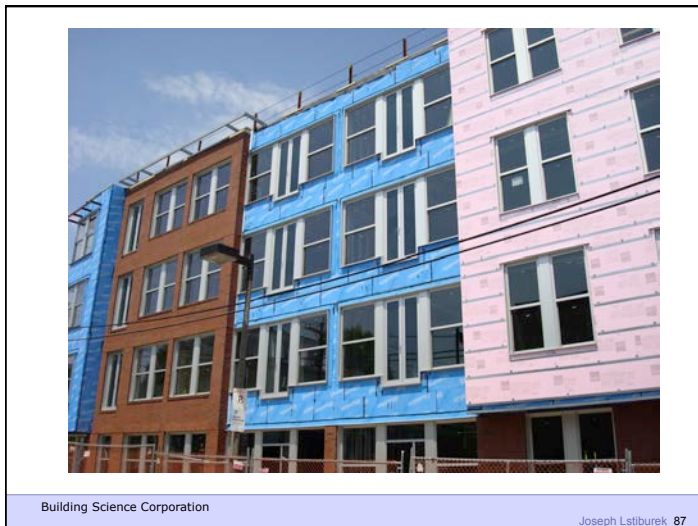
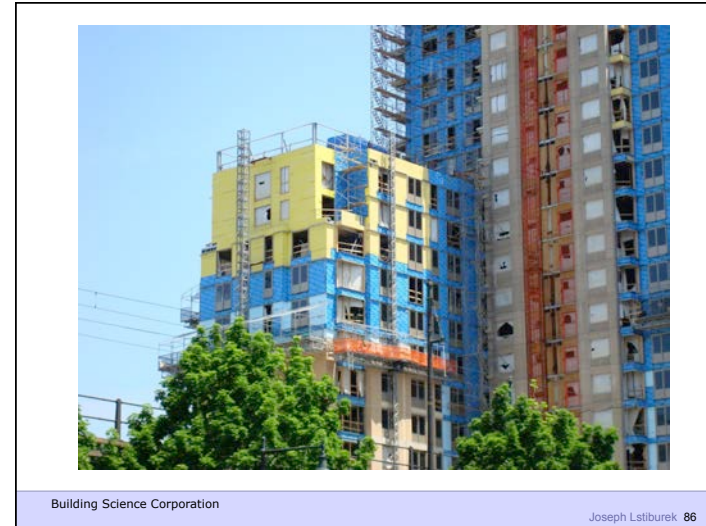



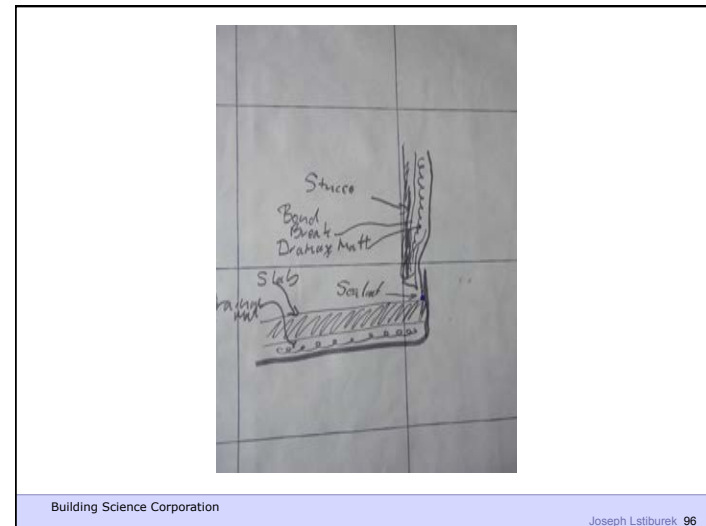
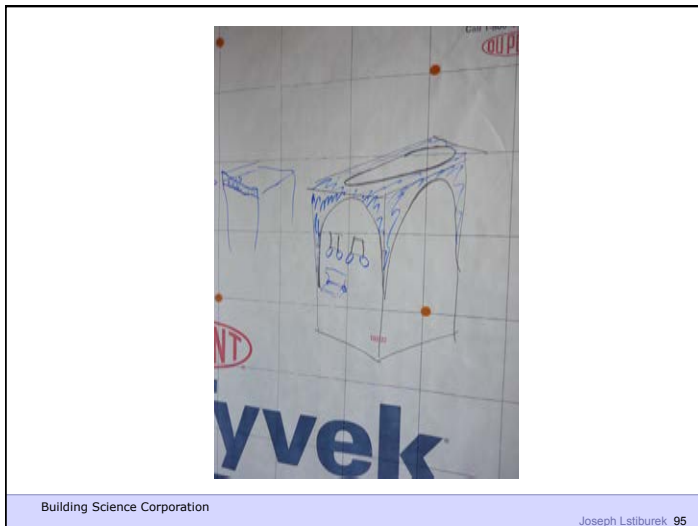

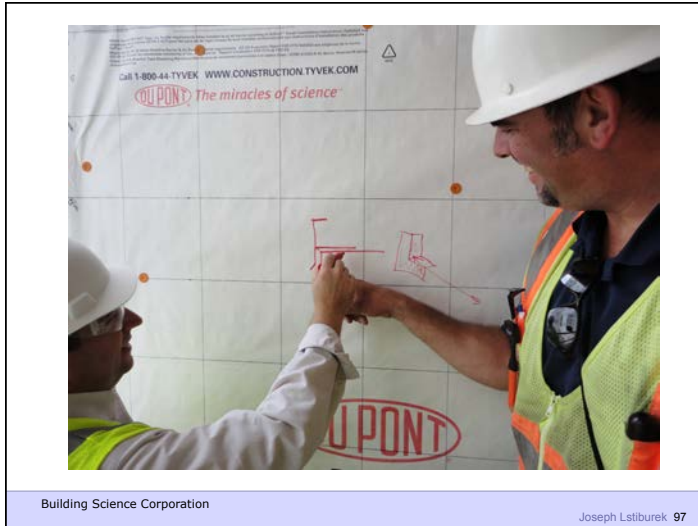

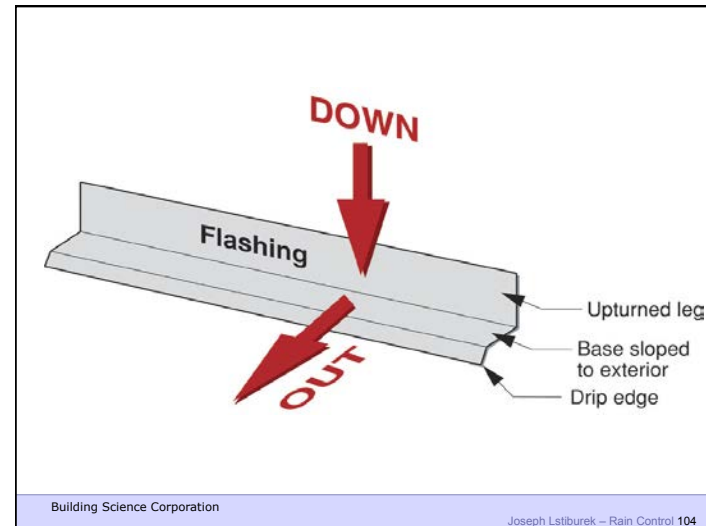
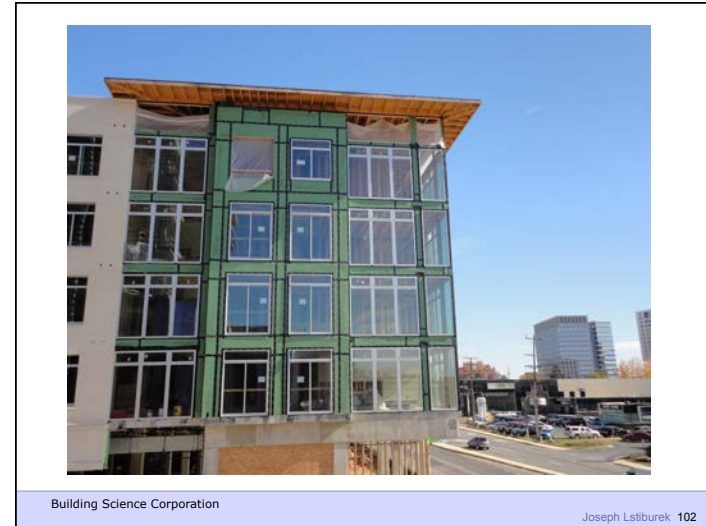

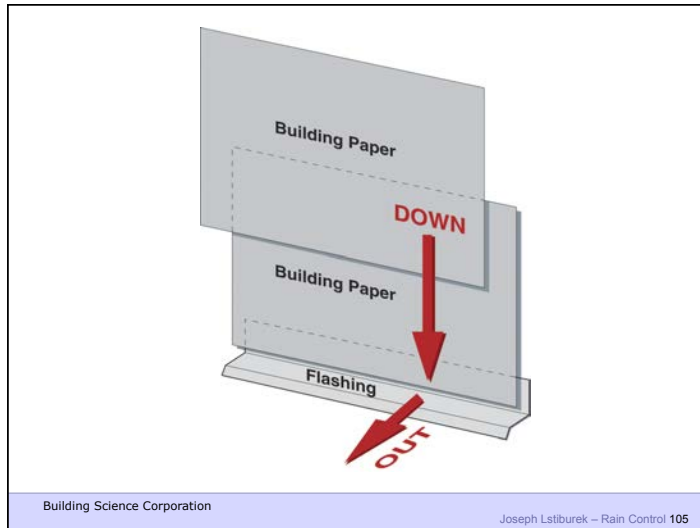

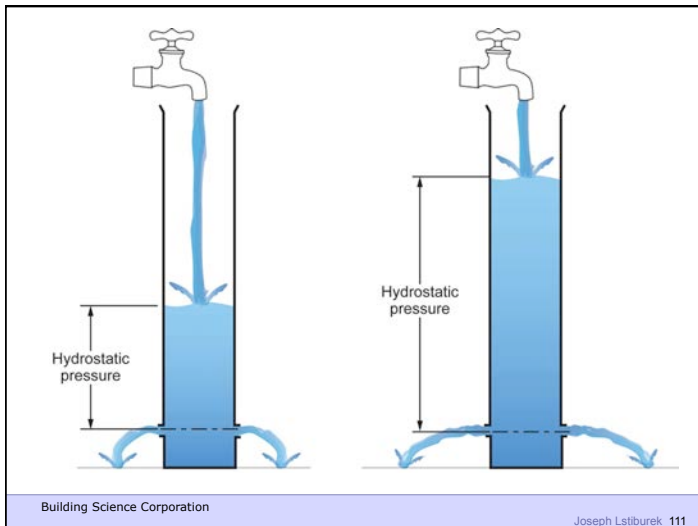

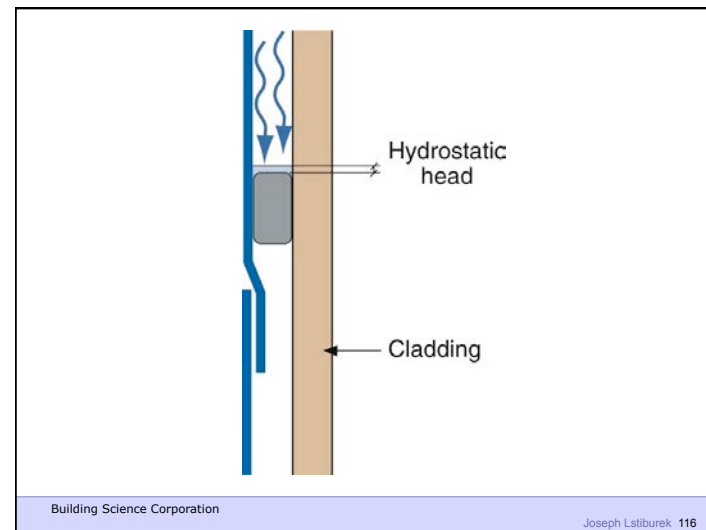
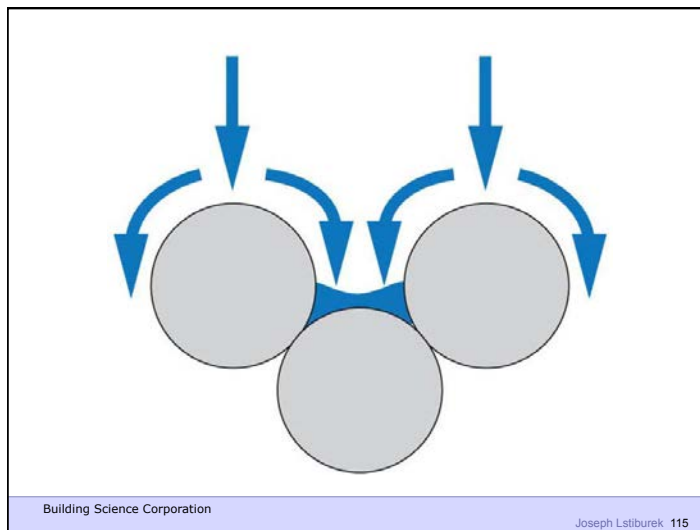
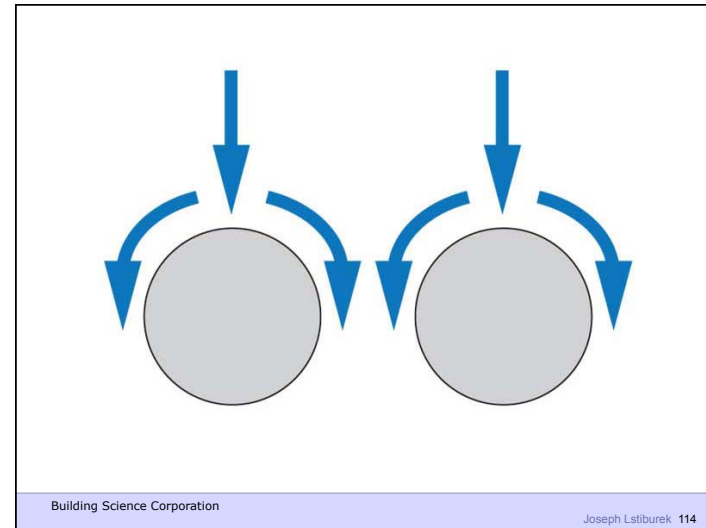
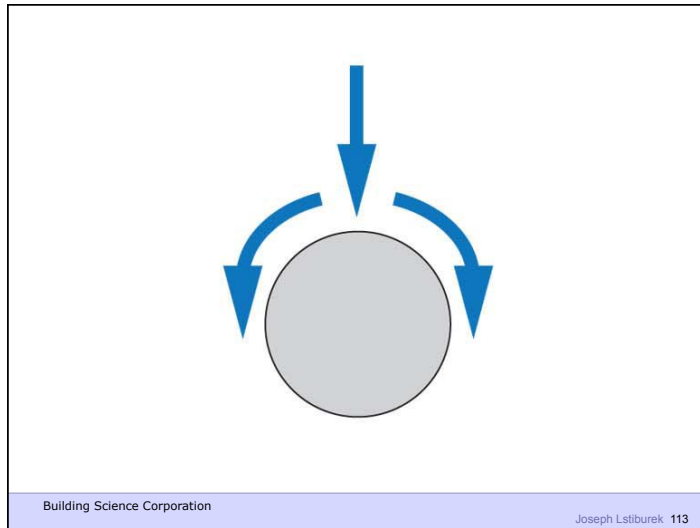

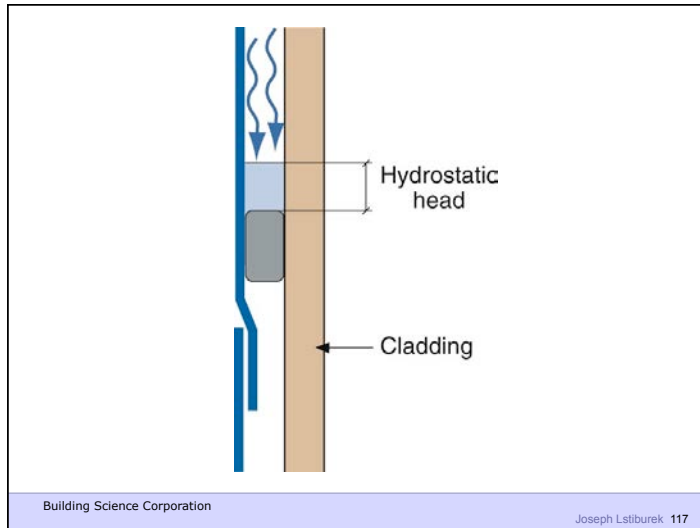

Building Science Corporation

Joseph Lstiburek 117

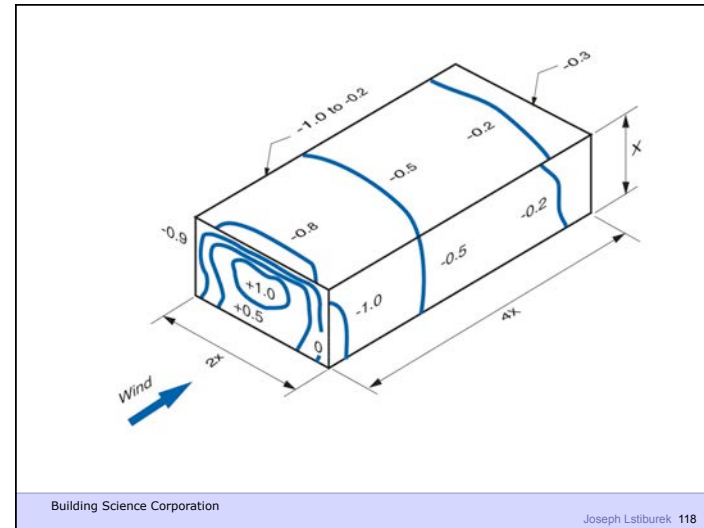

Building Science Corporation

Joseph Lstiburek 118

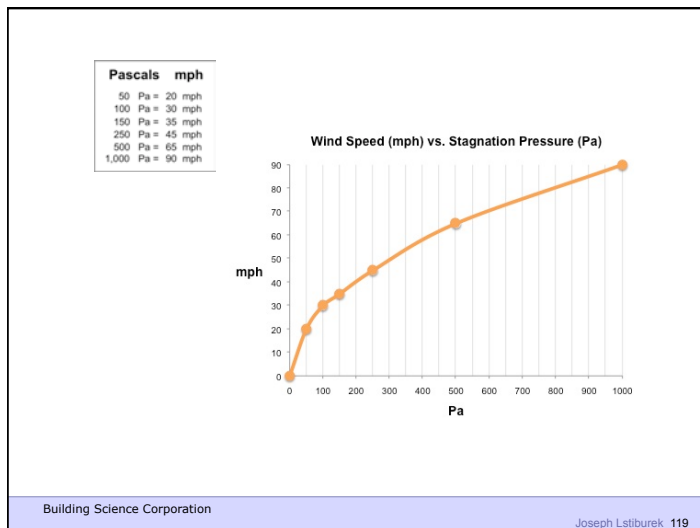

Building Science Corporation

Joseph Lstiburek 119



Building Science Corporation

Joseph Lstiburek 120

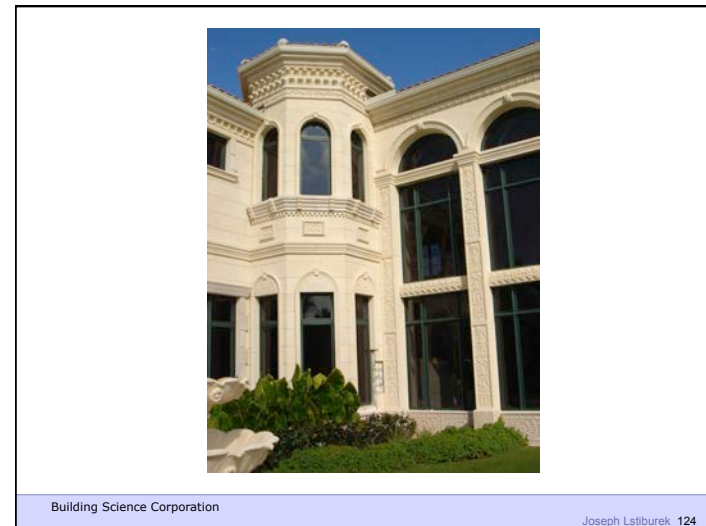
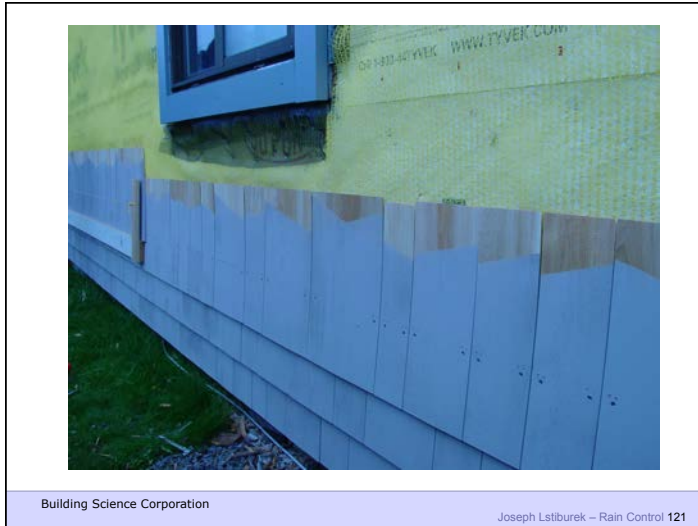

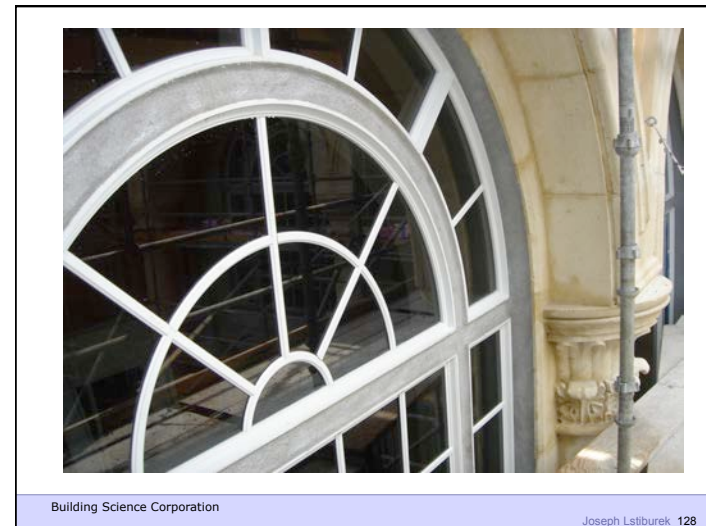
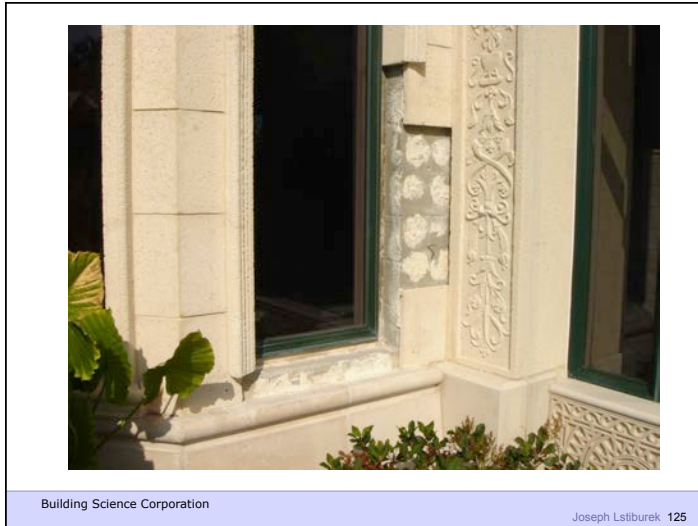

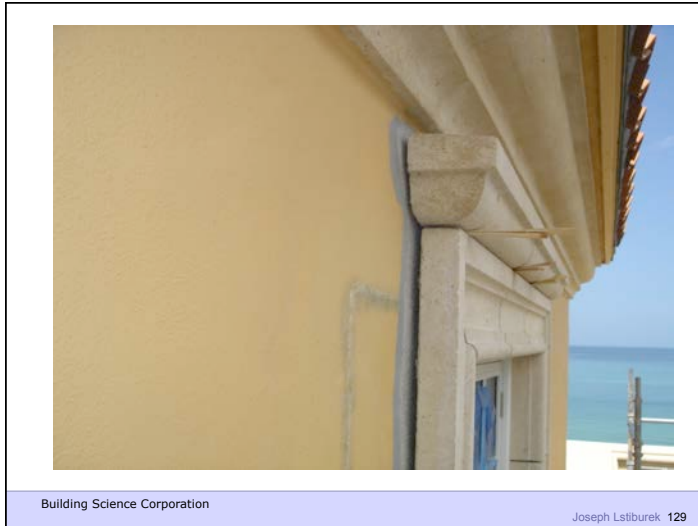

Building Science Corporation

Joseph Lstiburek 129

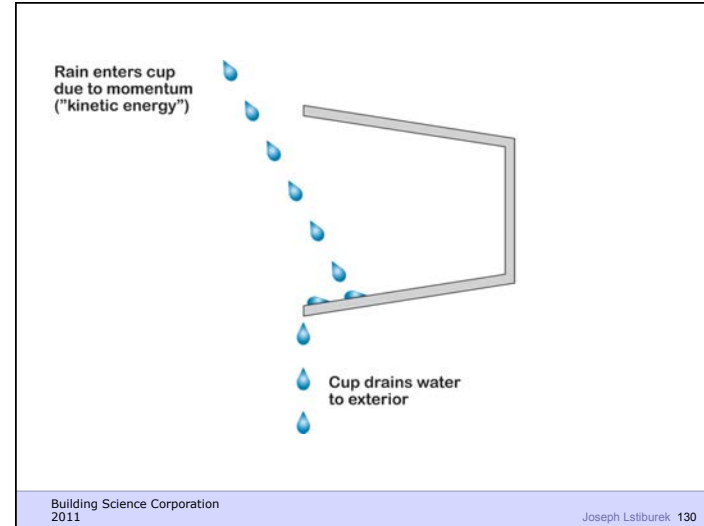

Building Science Corporation 2011

Joseph Lstiburek 130

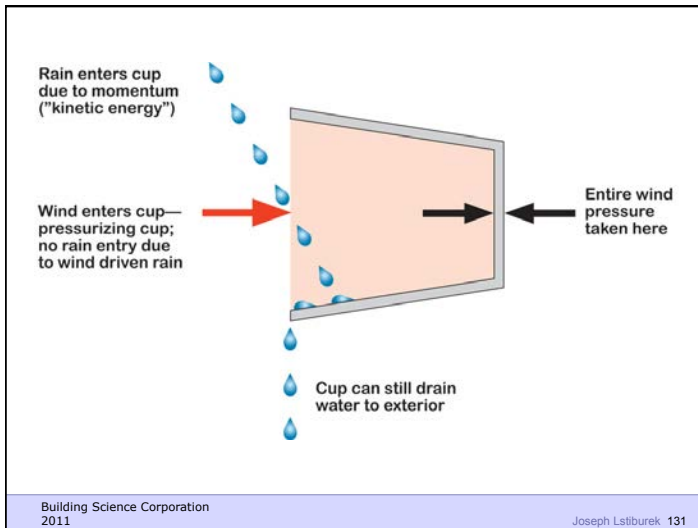

Building Science Corporation 2011

Joseph Lstiburek 131

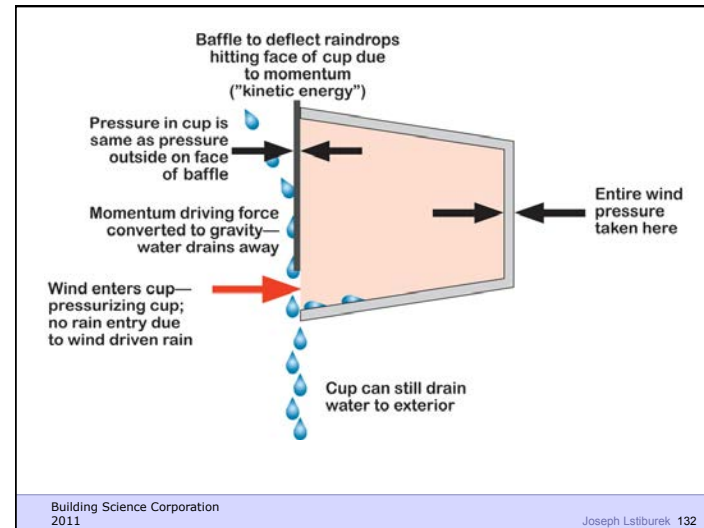

Building Science Corporation 2011

Joseph Lstiburek 132

