

Joseph Lstiburek, Ph.D., P.Eng, ASHRAE Fellow

Building Science

Adventures In Building Science

www.buildingscience.com

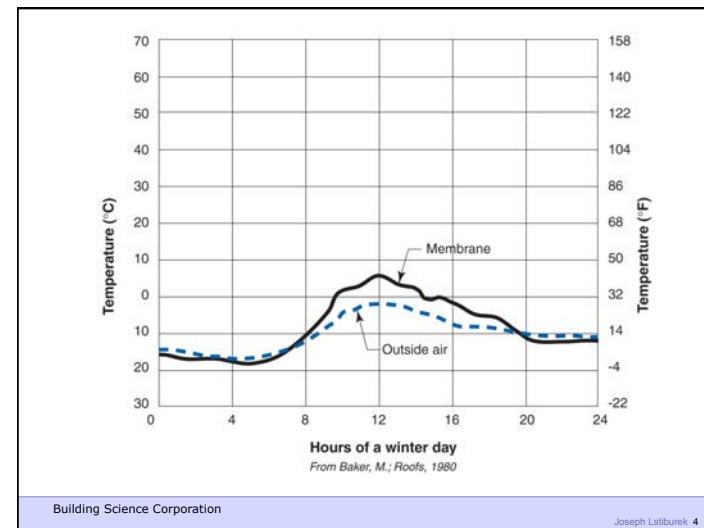
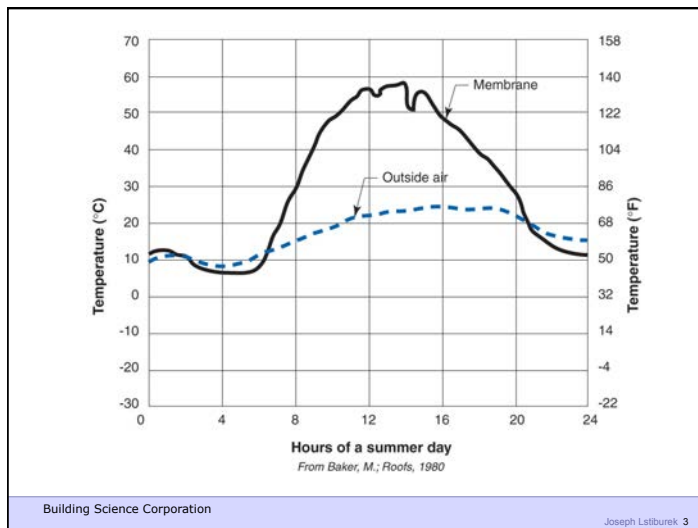
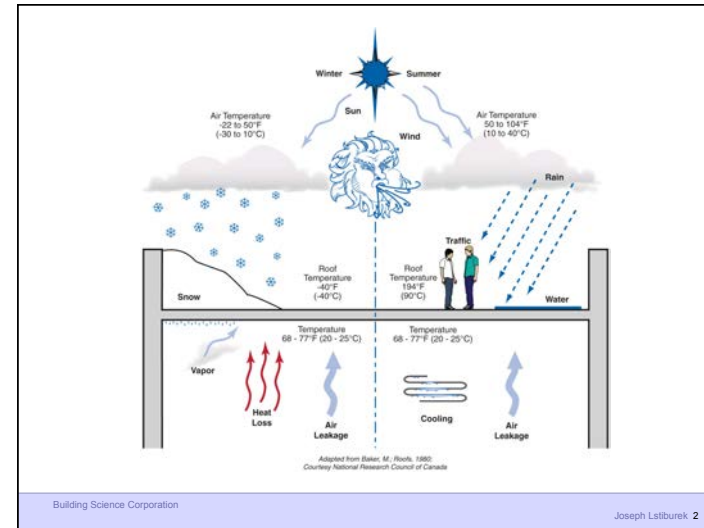

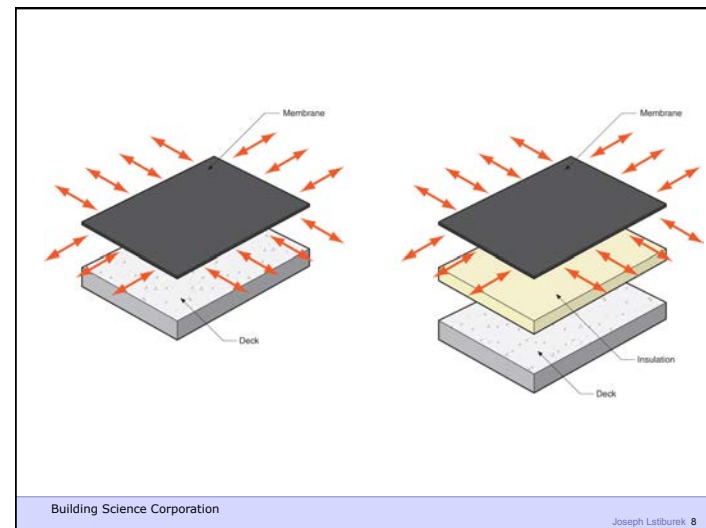
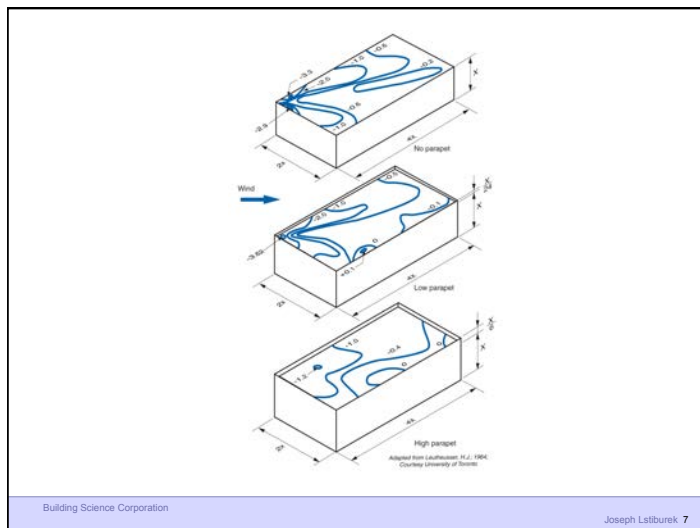
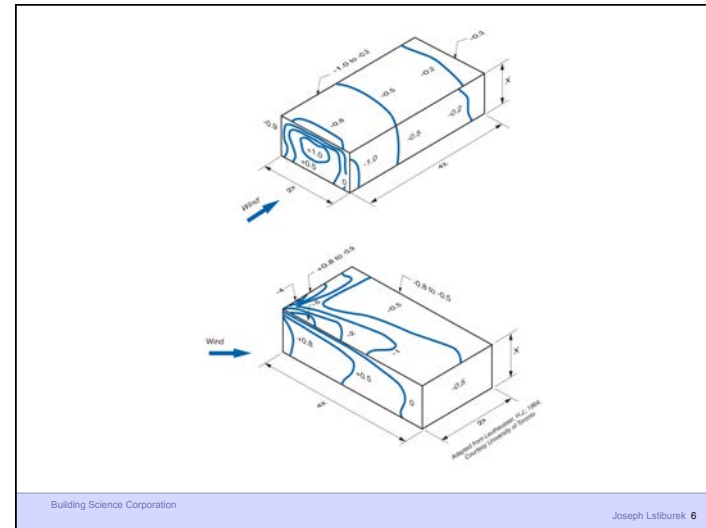
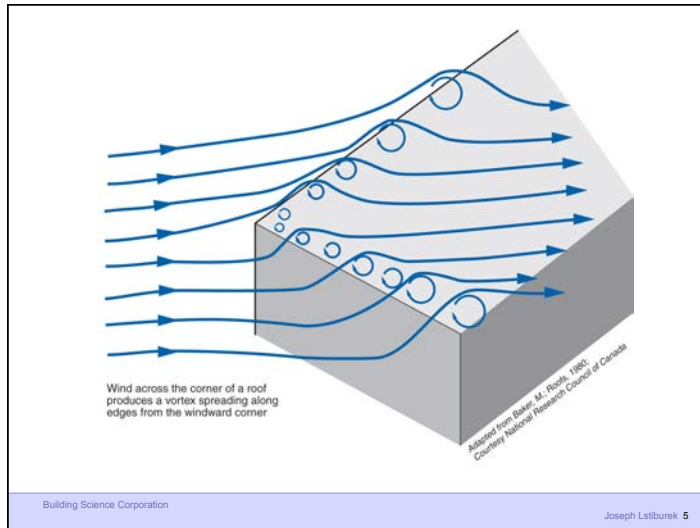

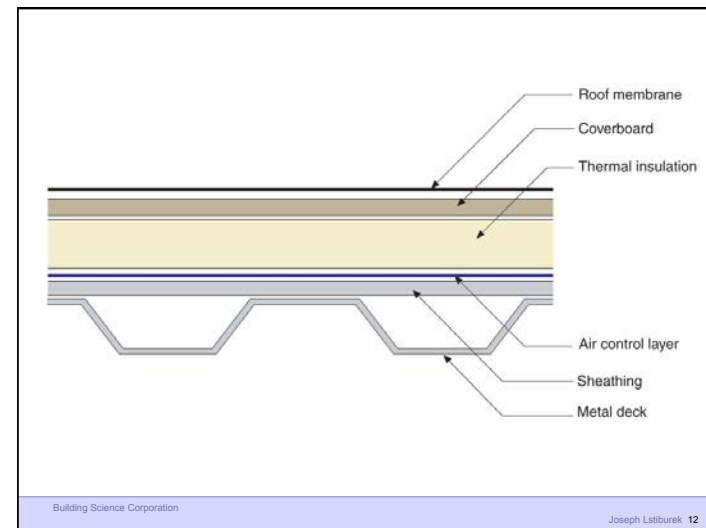
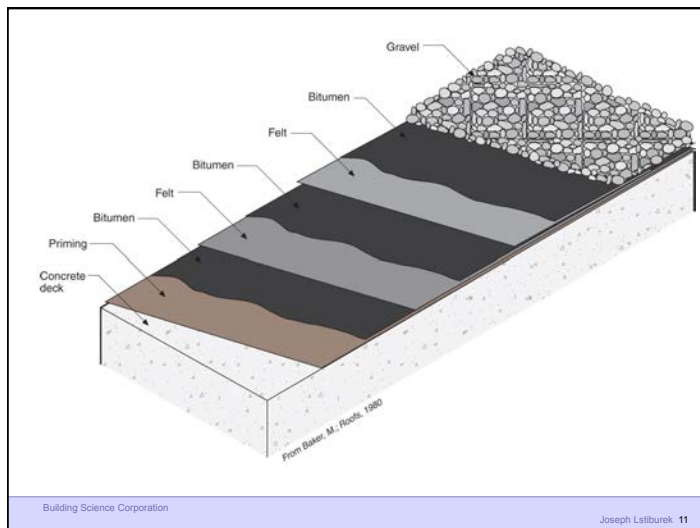
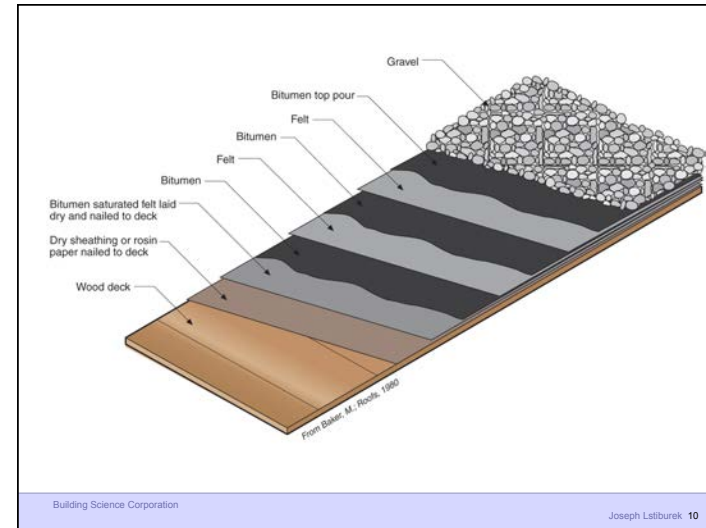
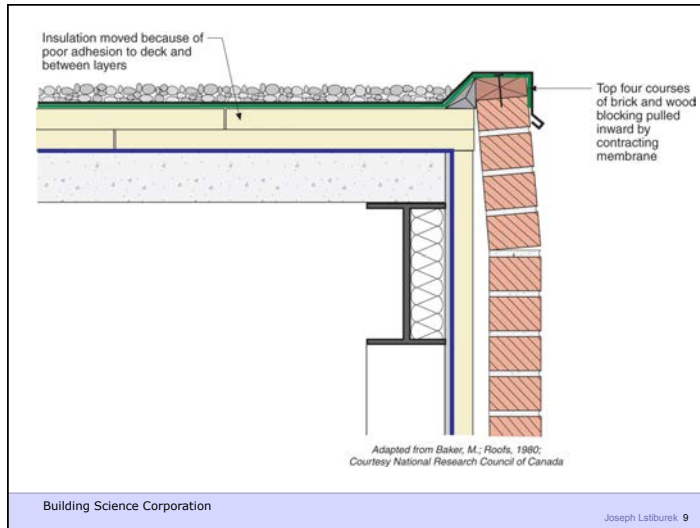

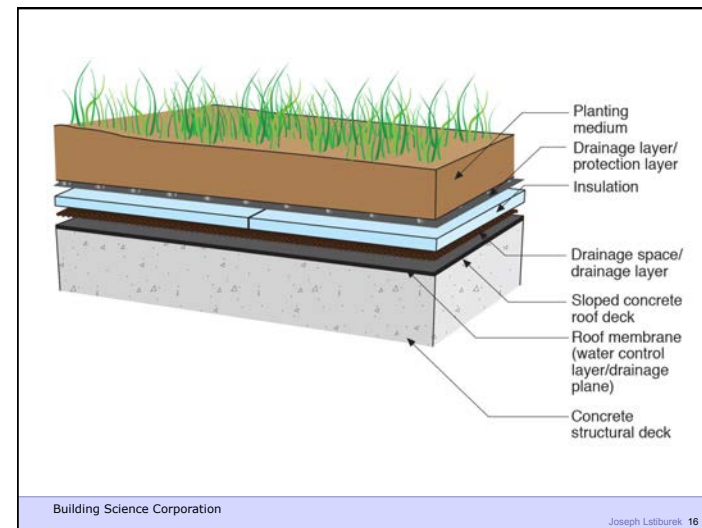
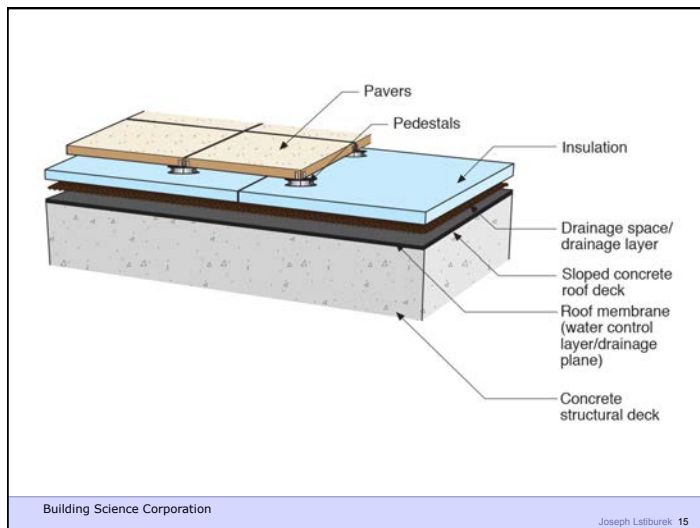
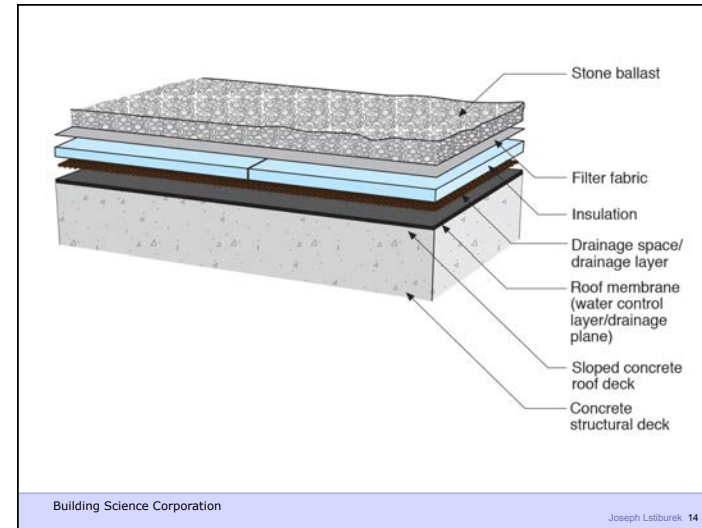
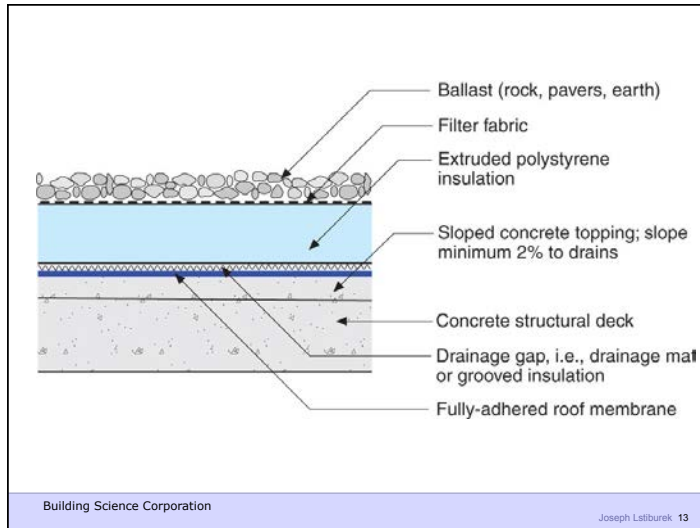

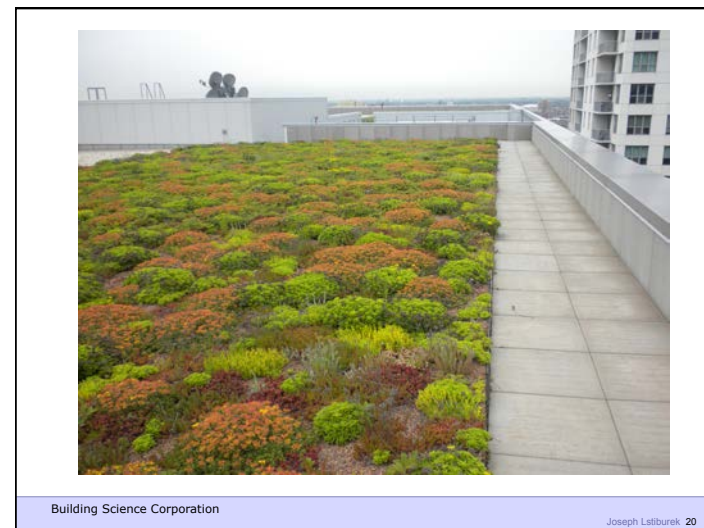
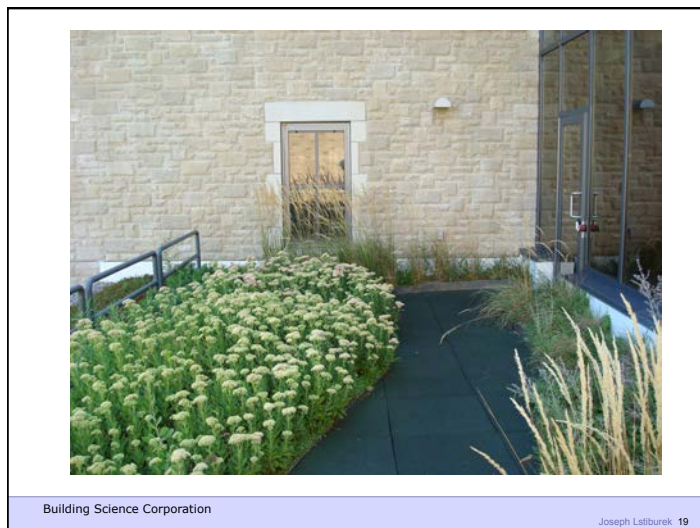
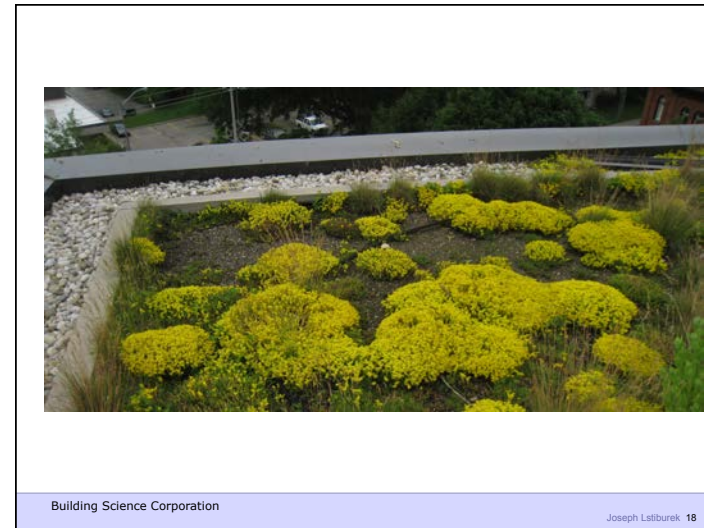
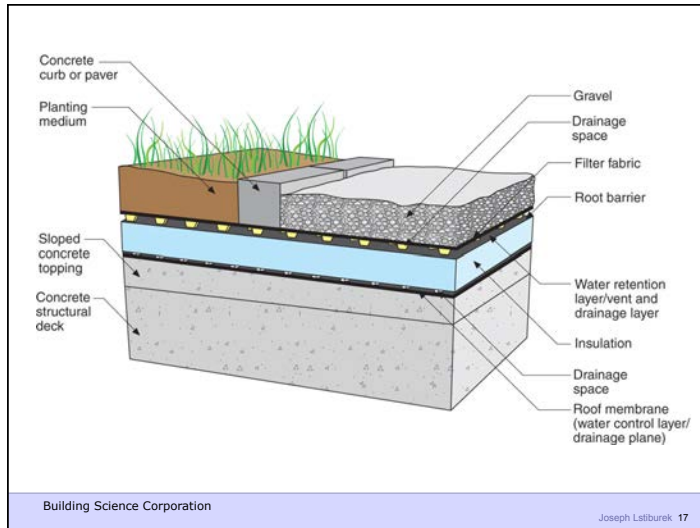

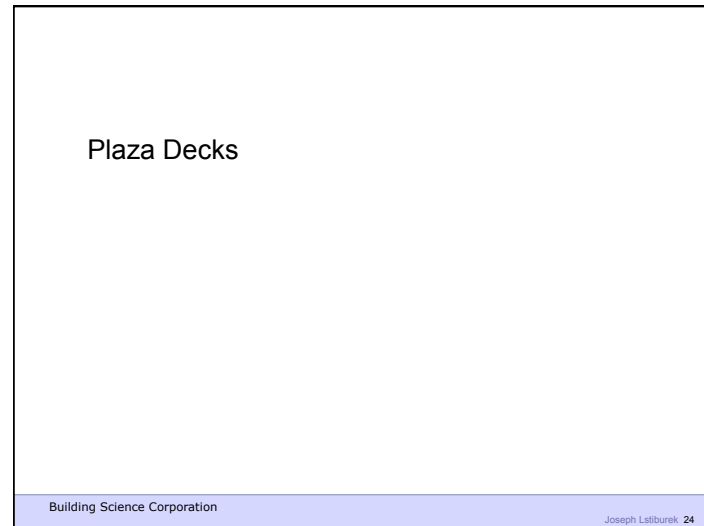
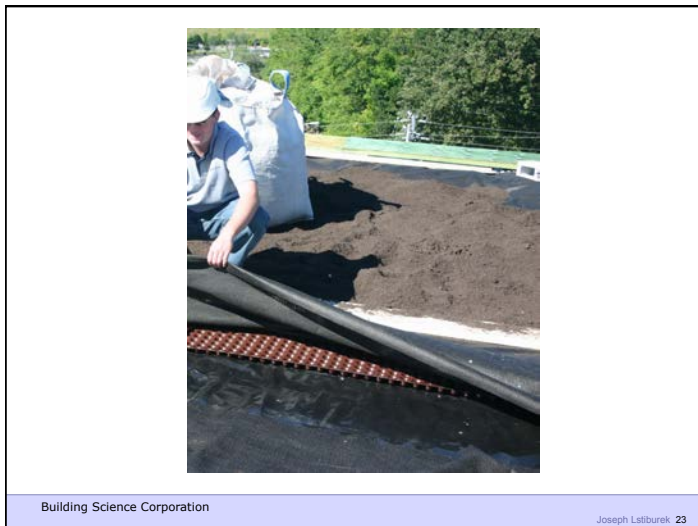
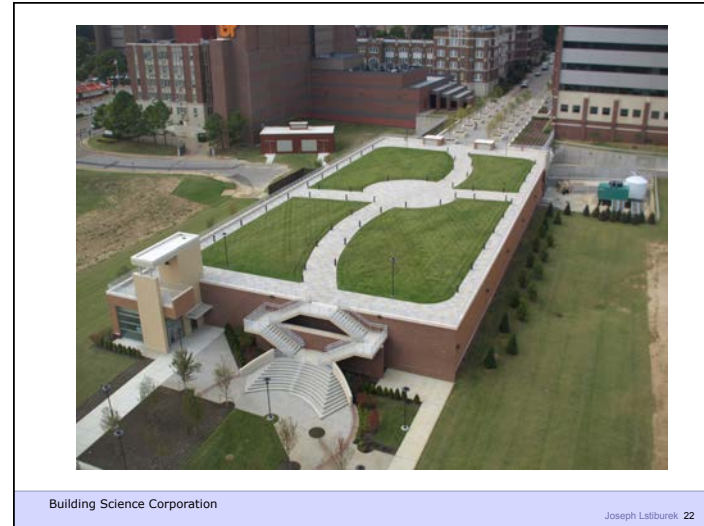
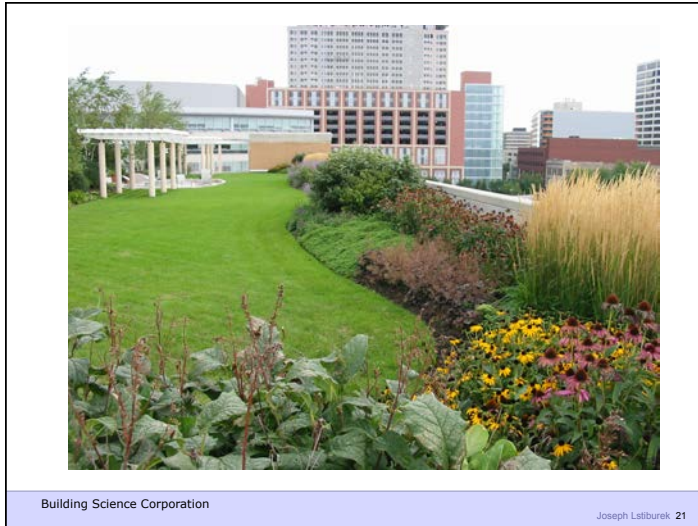

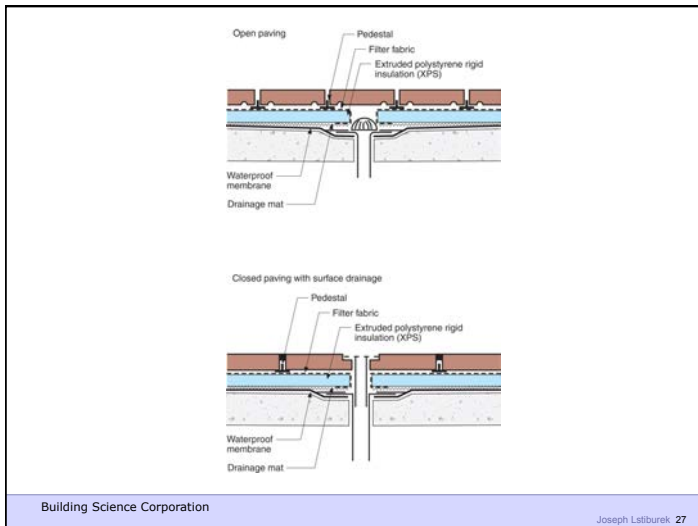
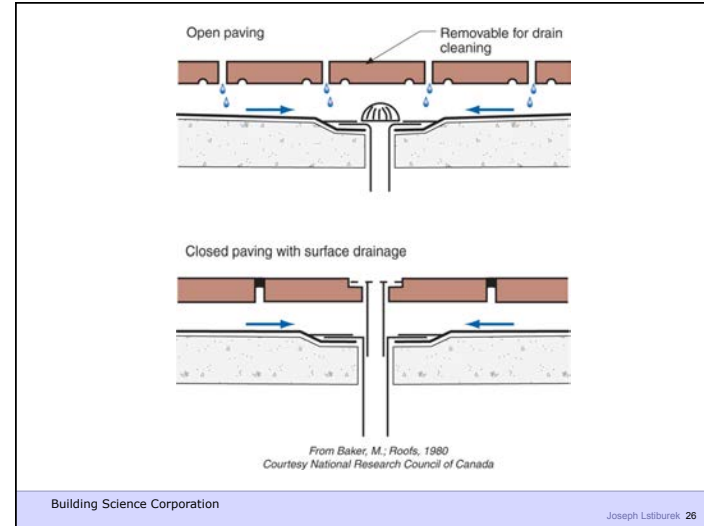

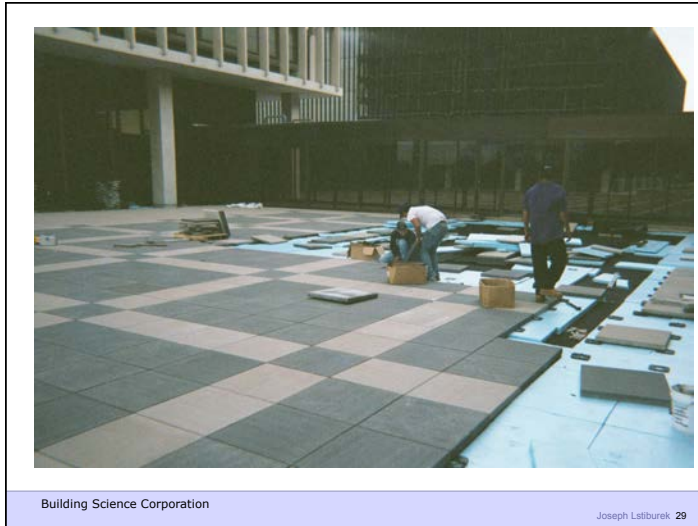

Plaza Decks
Gravity
Drainage Space
Capillary Break
Protection
Isolation

Building Science Corporation

Joseph Lstiburek 30

Plaza Decks
Gravity
Drainage Space
Capillary Break
Protection
Isolation
...oh and you better get it right.....

Building Science Corporation

Joseph Lstiburek 31

Plaza Decks Are Really Protected
Membrane Roofs

Building Science Corporation

Joseph Lstiburek 32

Plaza Decks Are Really Protected
Membrane Roofs
Not Easily Serviceable

Building Science Corporation Joseph Lstiburek 33

Plaza Decks Are Really Protected
Membrane Roofs
Not Easily Serviceable
Should Be Isolated And Protected From All
Other Building and Waterproofing
Components

Building Science Corporation Joseph Lstiburek 34

Plaza Deck Systems
Hot Fluid Applied Membranes
Cold Fluid Applied Membranes

Building Science Corporation Joseph Lstiburek 35



Building Science Corporation Joseph Lstiburek 36

Osmosis

Building Science Corporation

Joseph Lstiburek 37

Paver
Pedestal
Filter fabric
Extruded polystyrene rigid insulation (XPS)
Concrete slab
Membrane

Building Science Corporation

Joseph Lstiburek 38

Vapor diffusion
Top of membrane is wet

Building Science Corporation

Joseph Lstiburek 39

Vapor diffusion
Pore condensation dissolves minerals creating solute

Building Science Corporation

Joseph Lstiburek 40

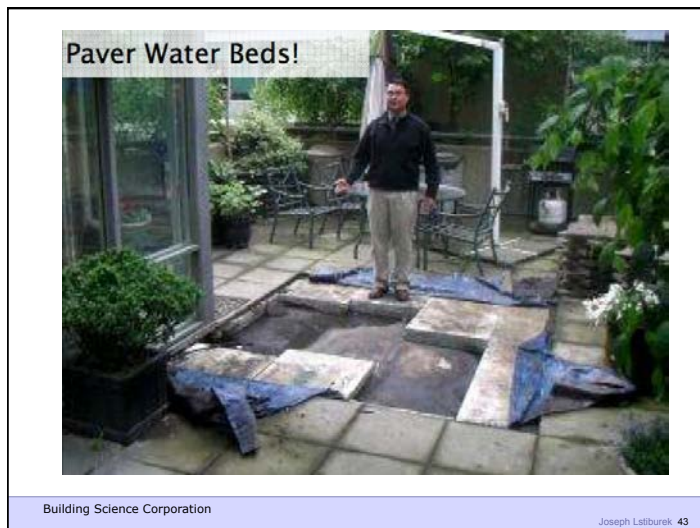
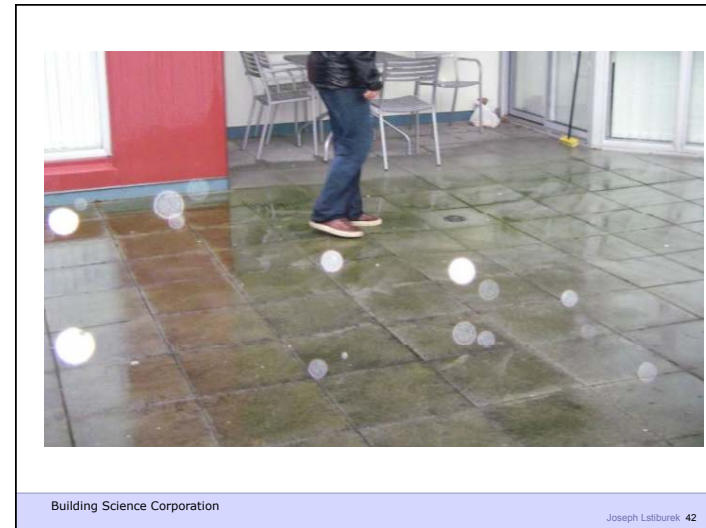
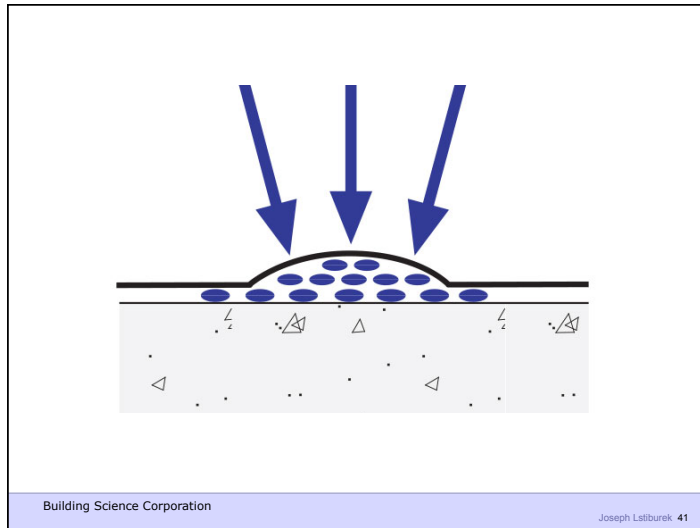

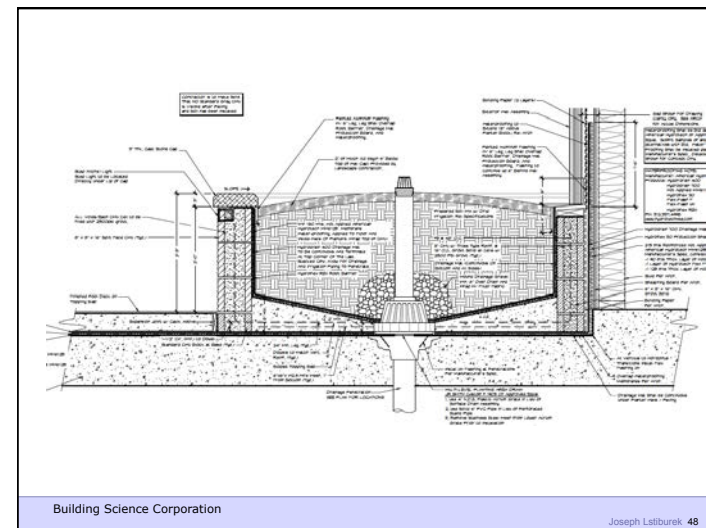
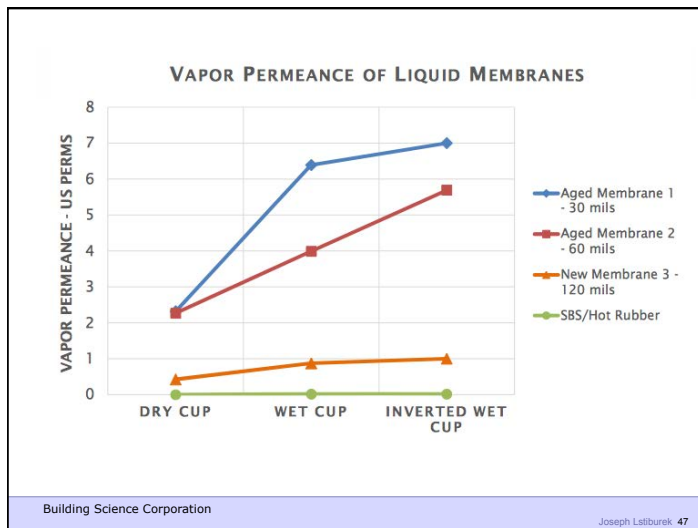

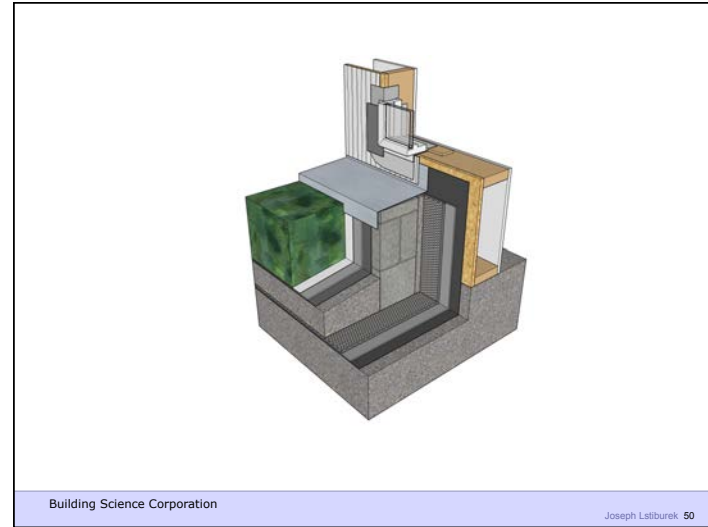
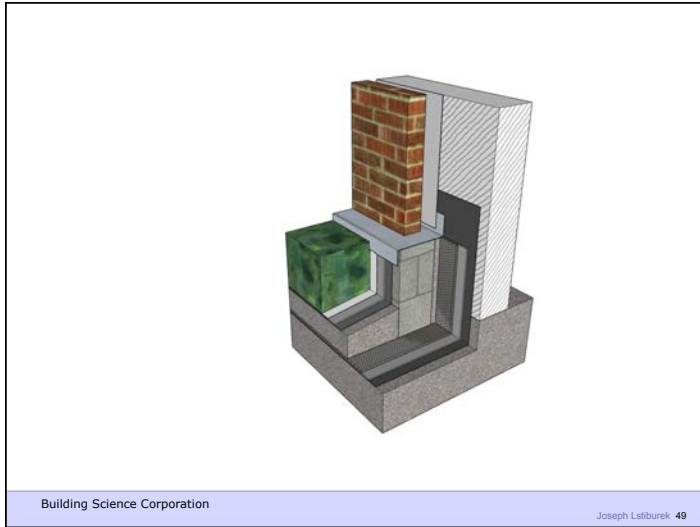

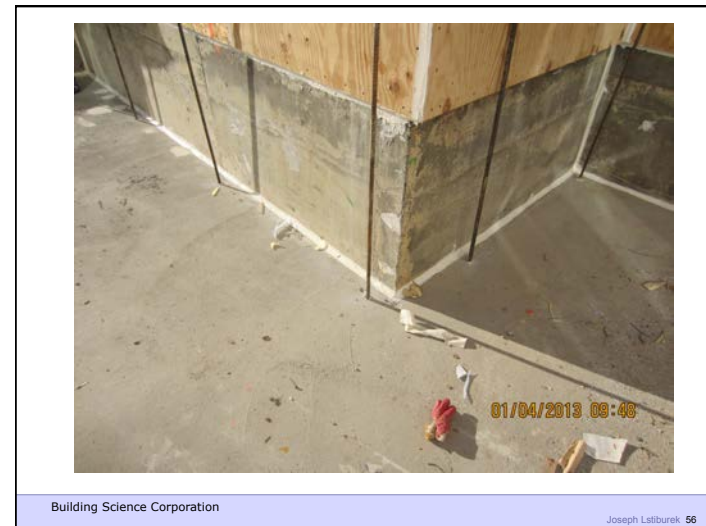
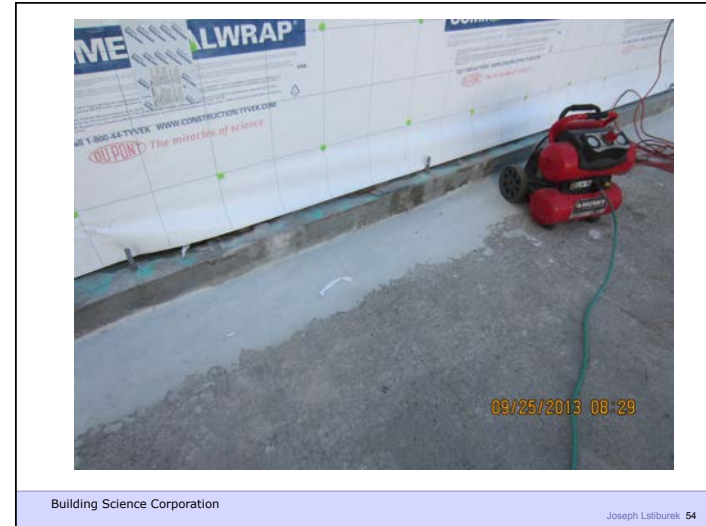
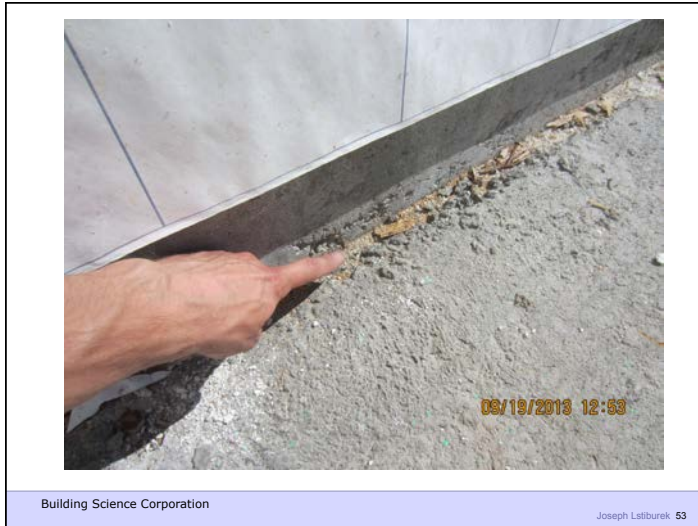

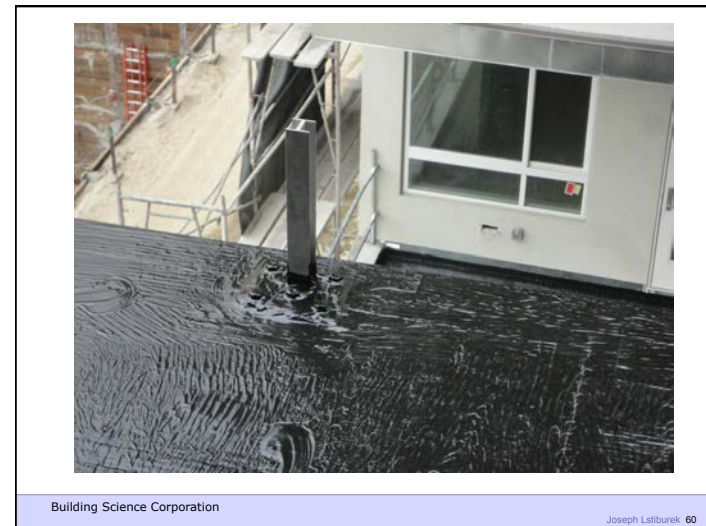
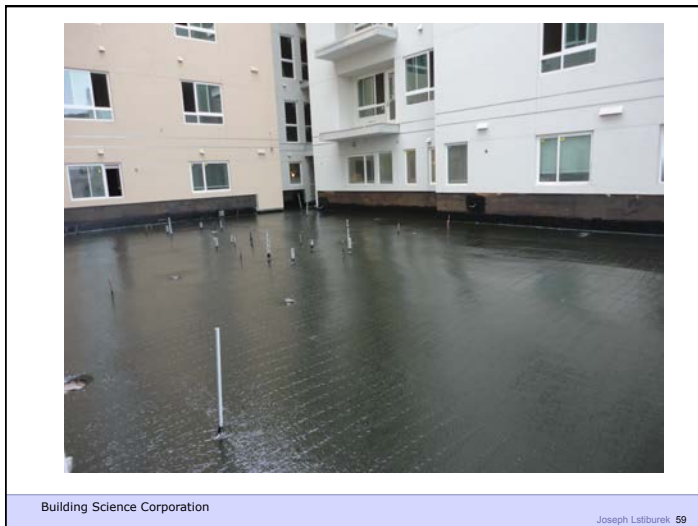

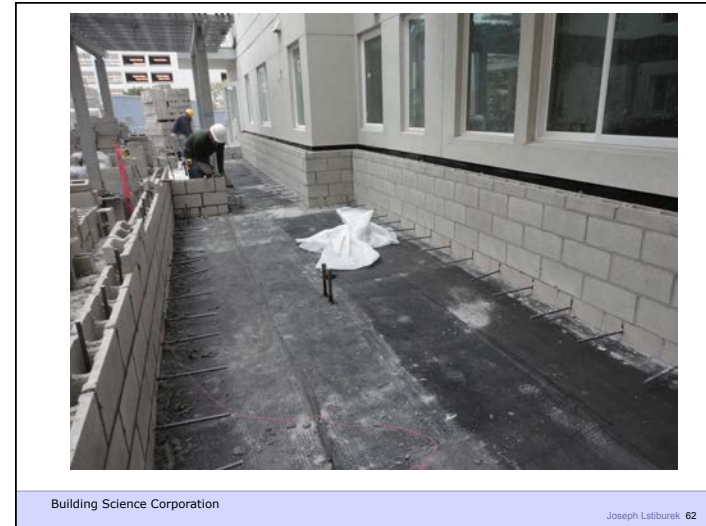

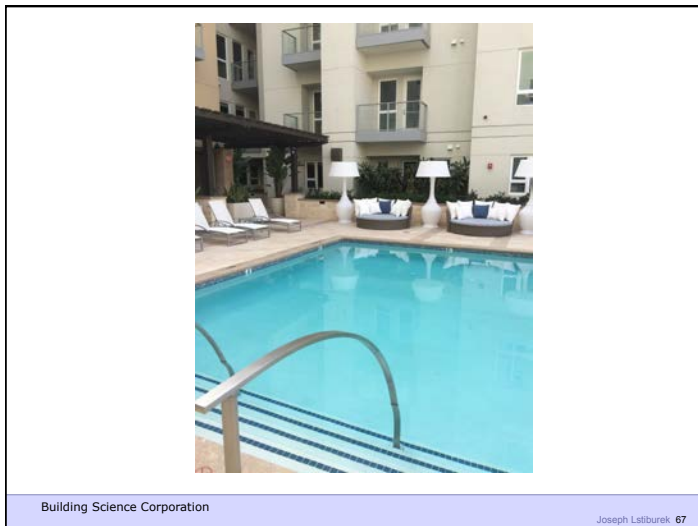

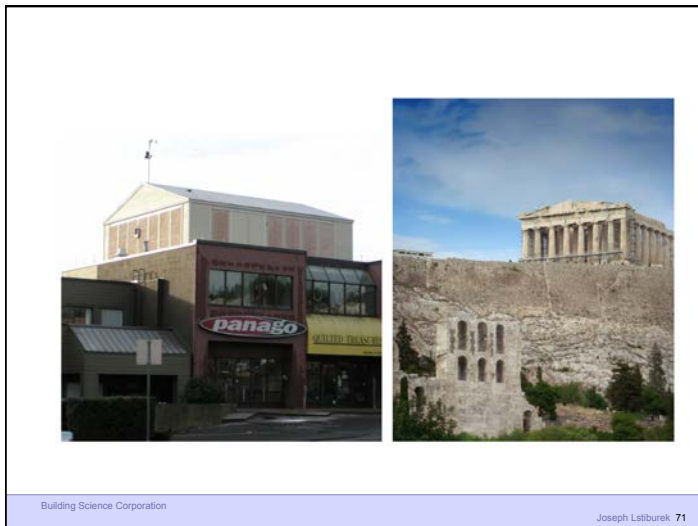
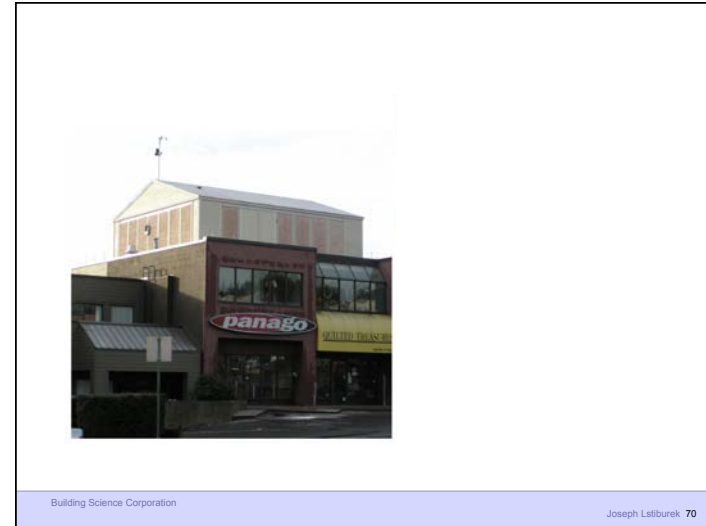
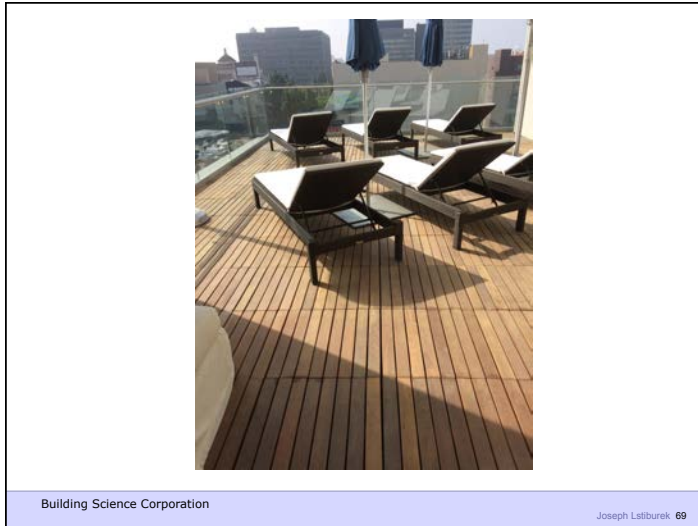

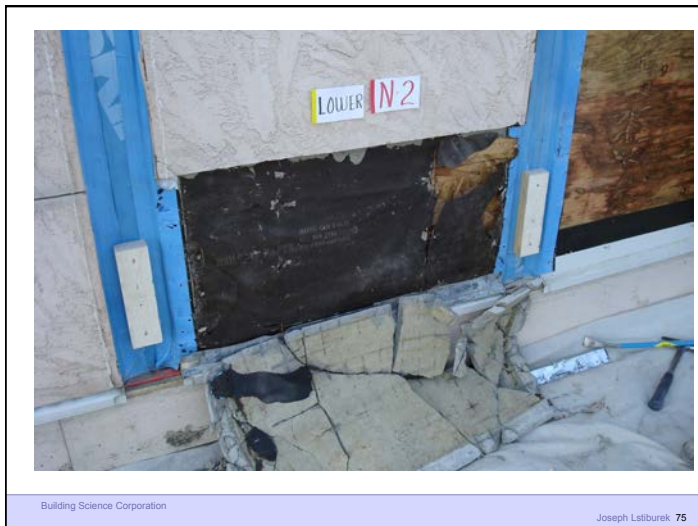
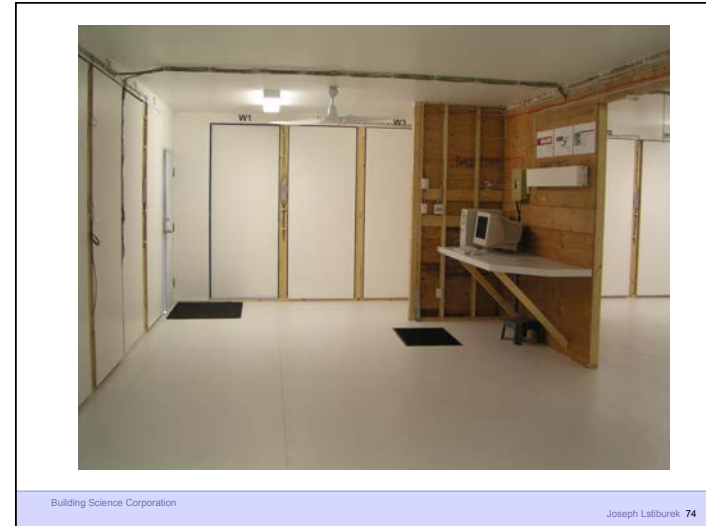
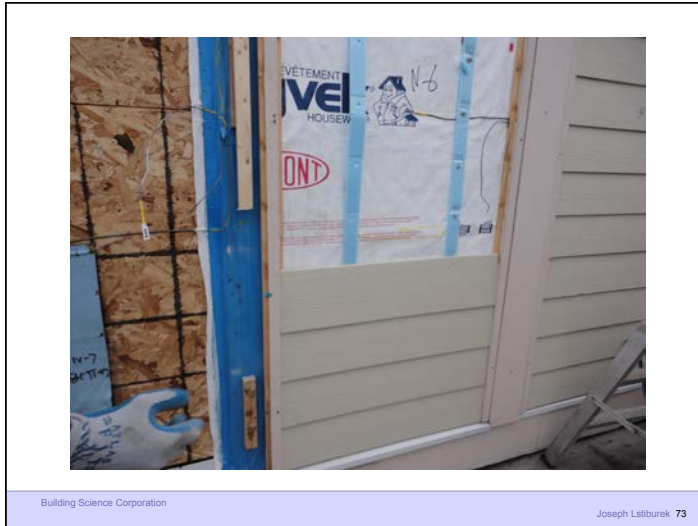

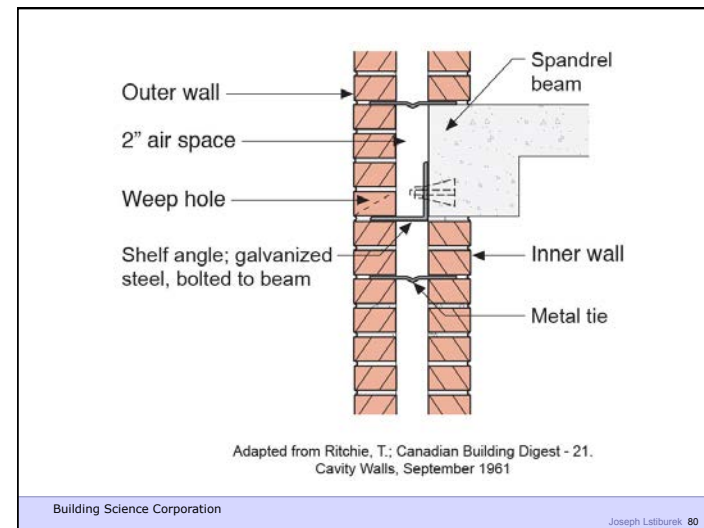
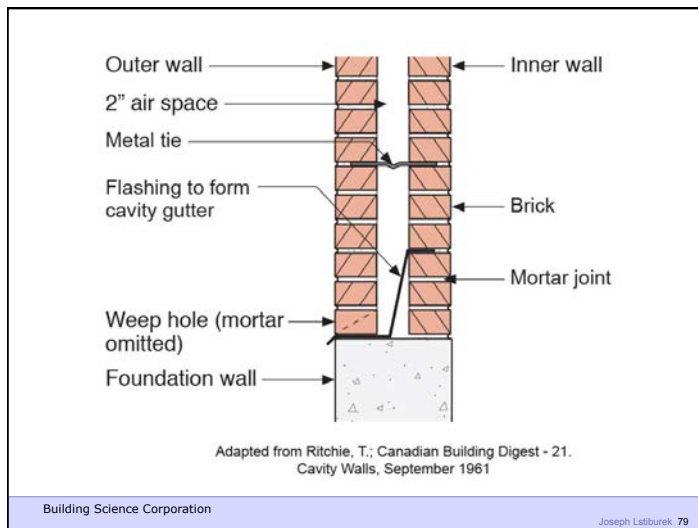
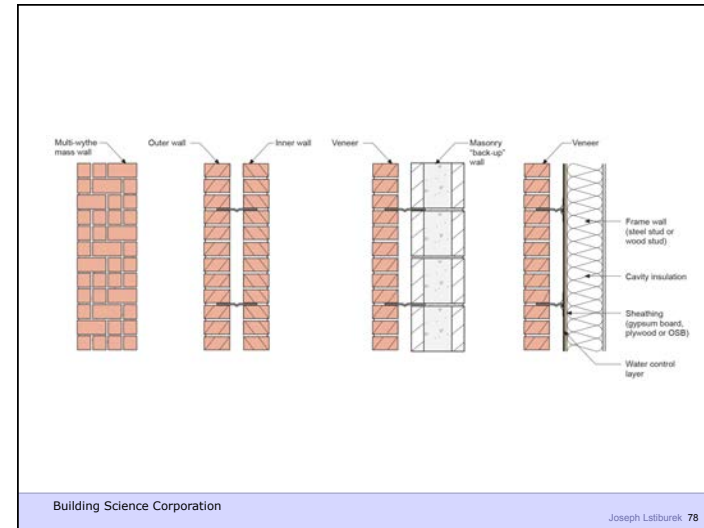

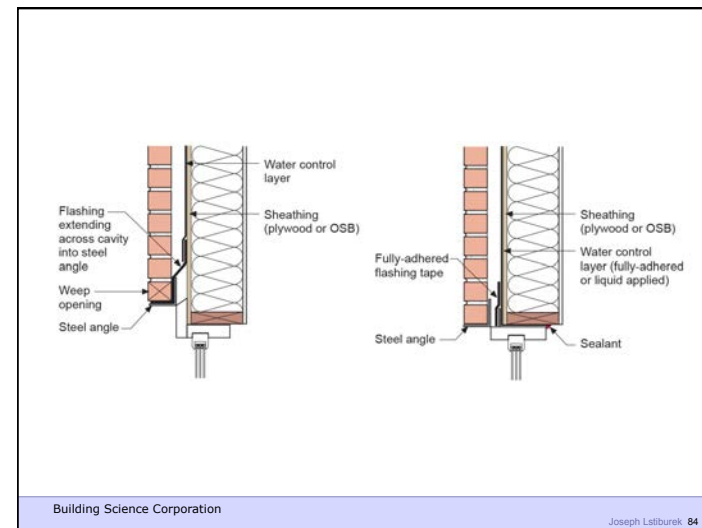
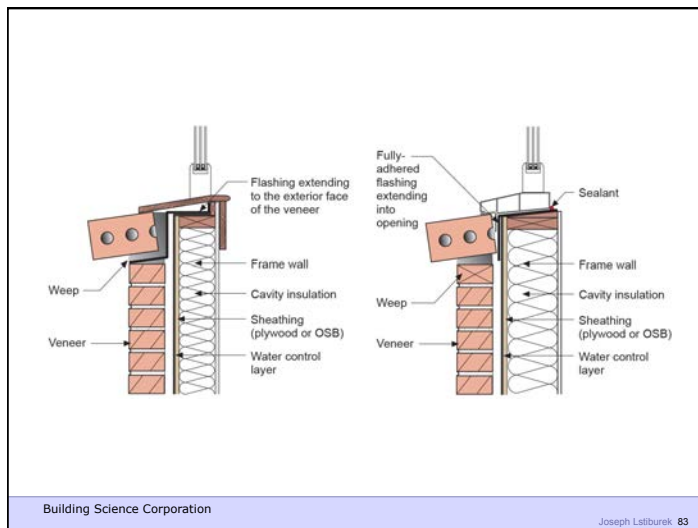
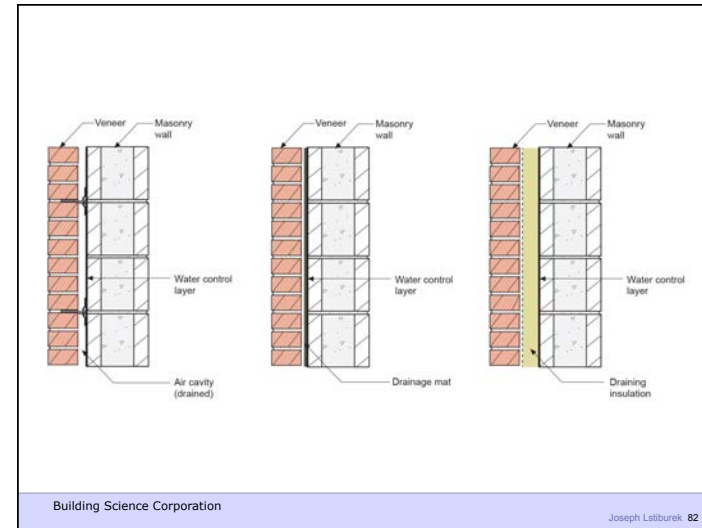
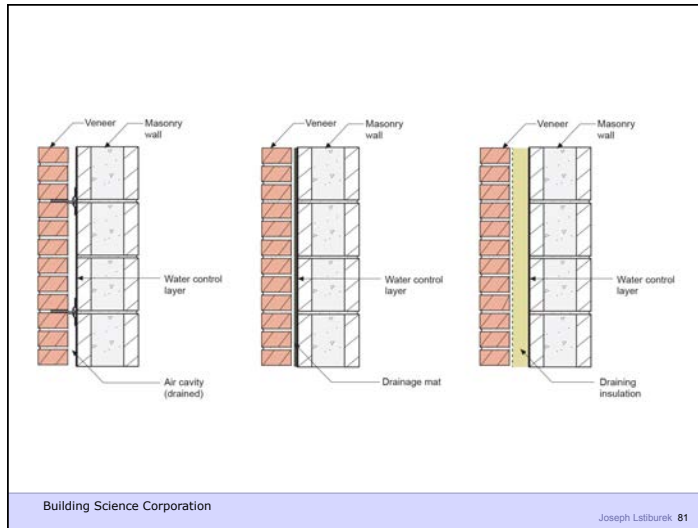



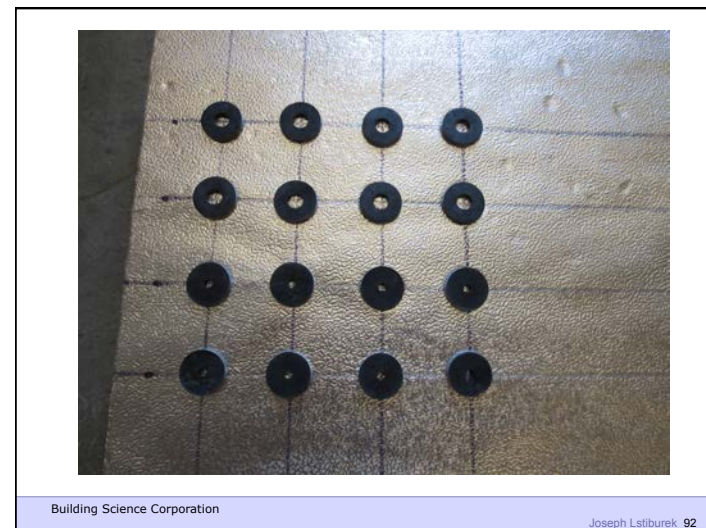
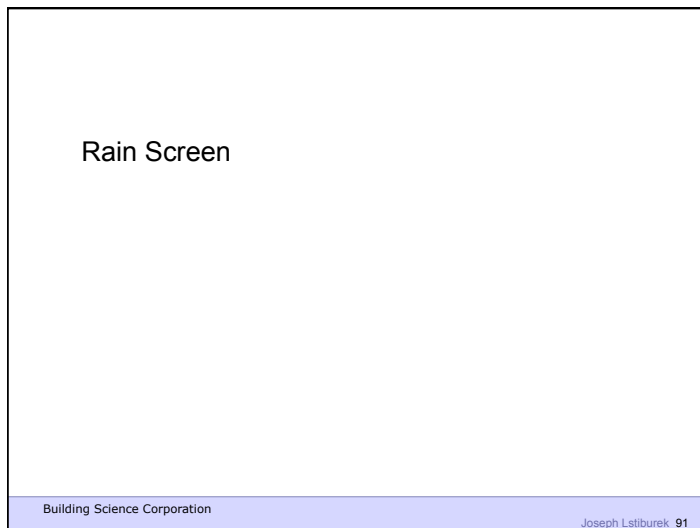
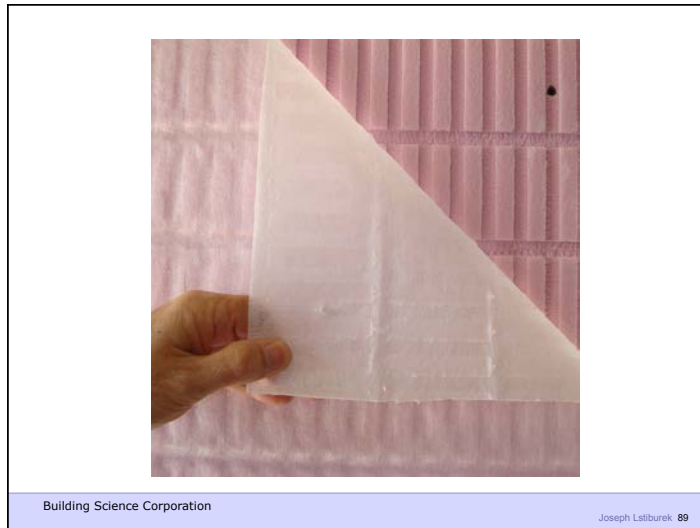

Beer Screen?

Building Science Corporation Joseph Lstiburek 93

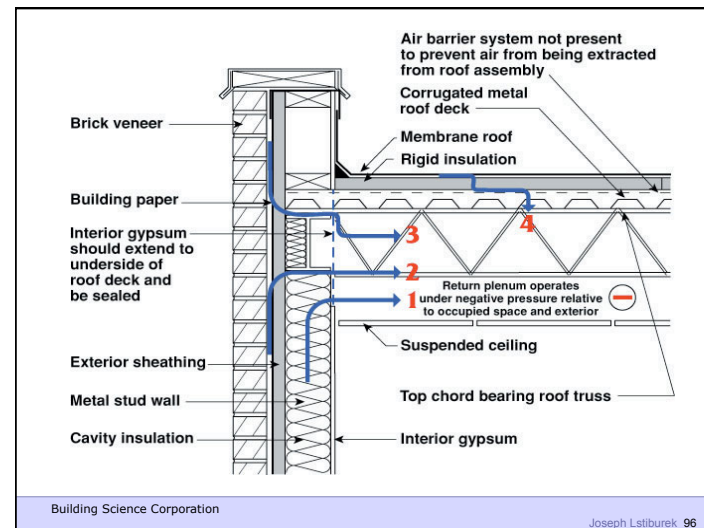
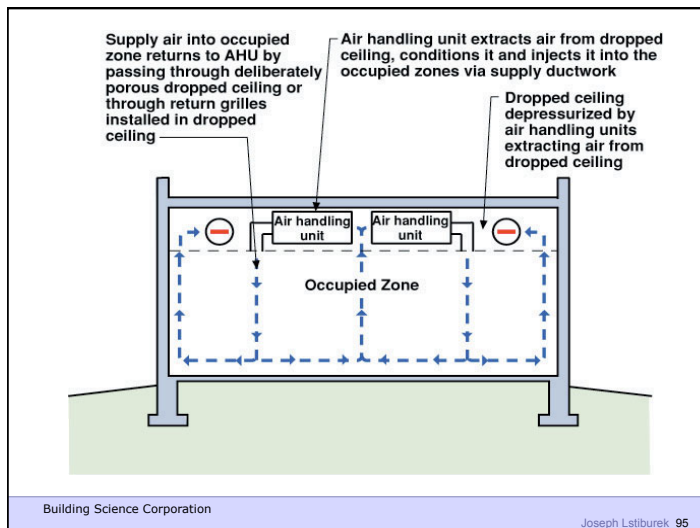
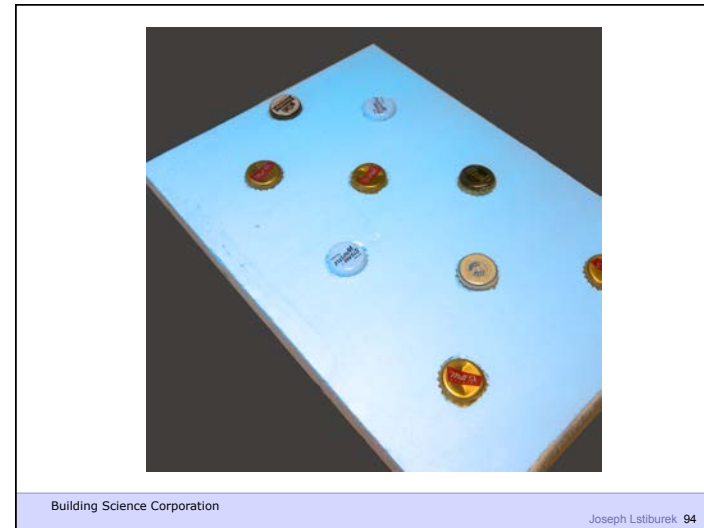

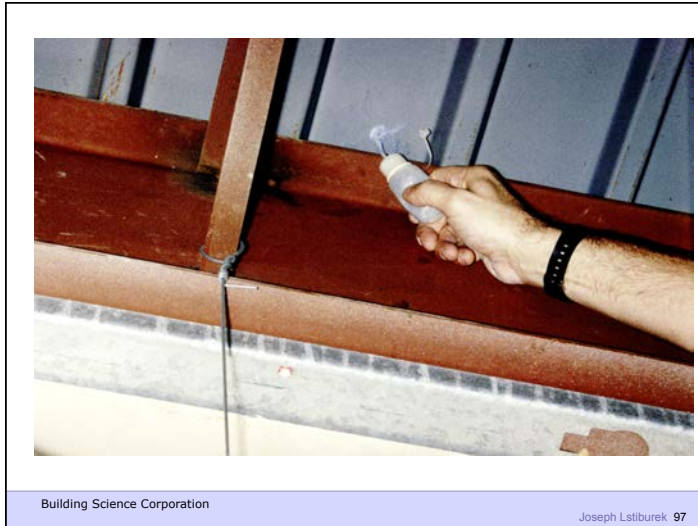

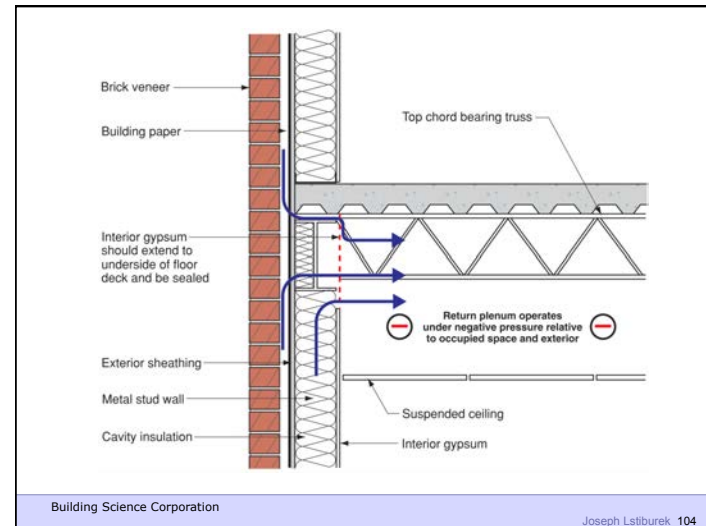
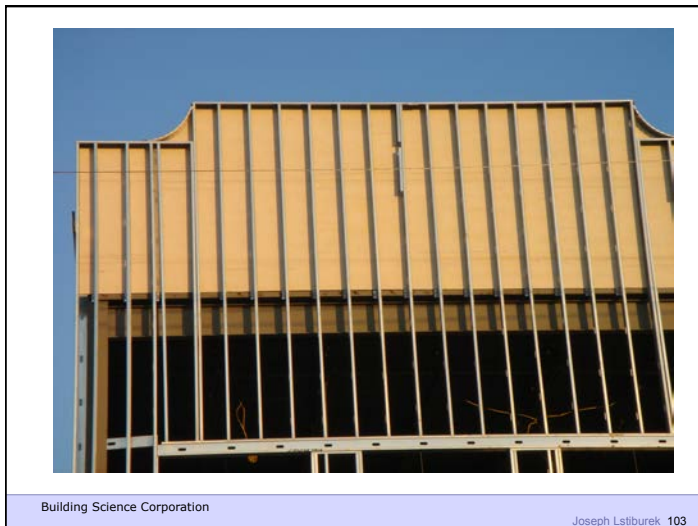
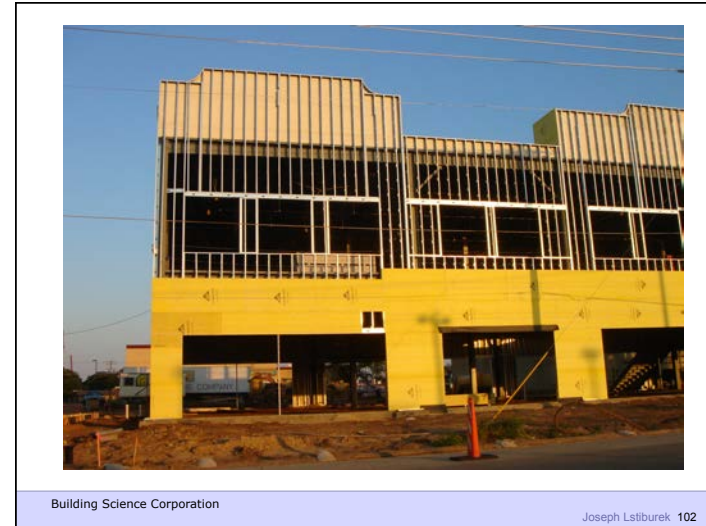
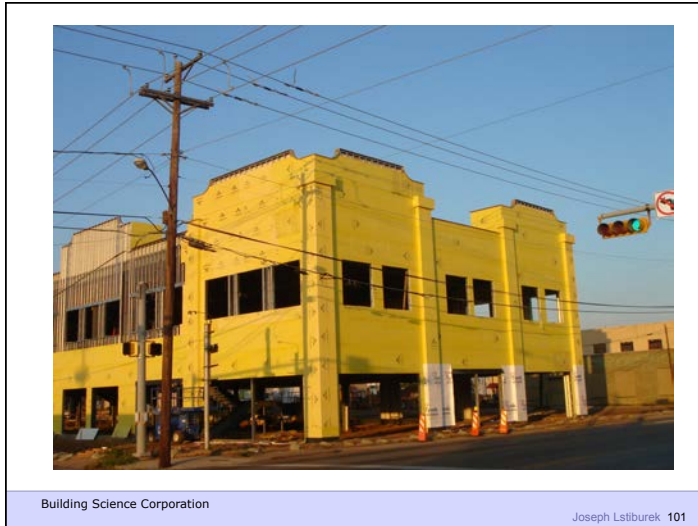

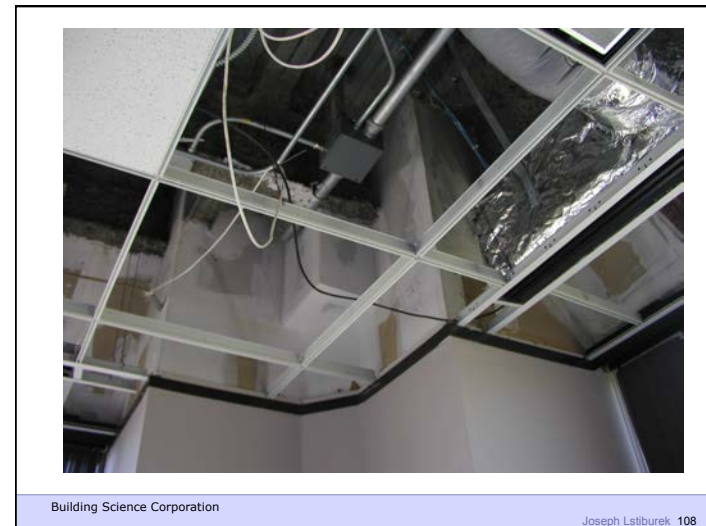
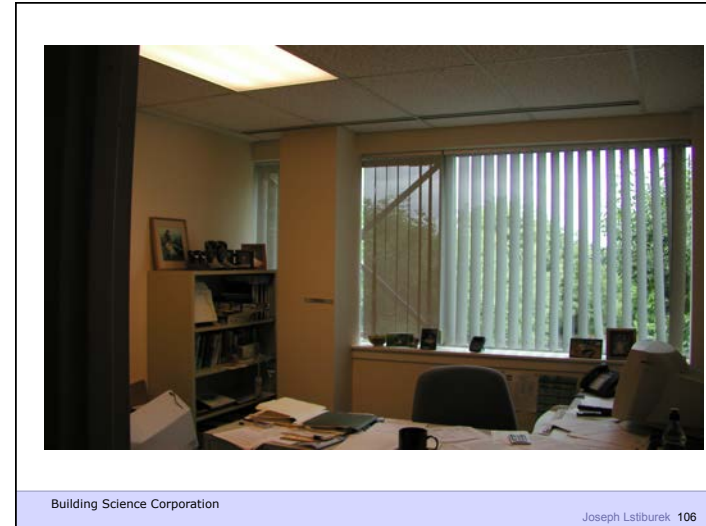



Building Science Corporation

Joseph Lstiburek 109



Building Science Corporation

Joseph Lstiburek 110

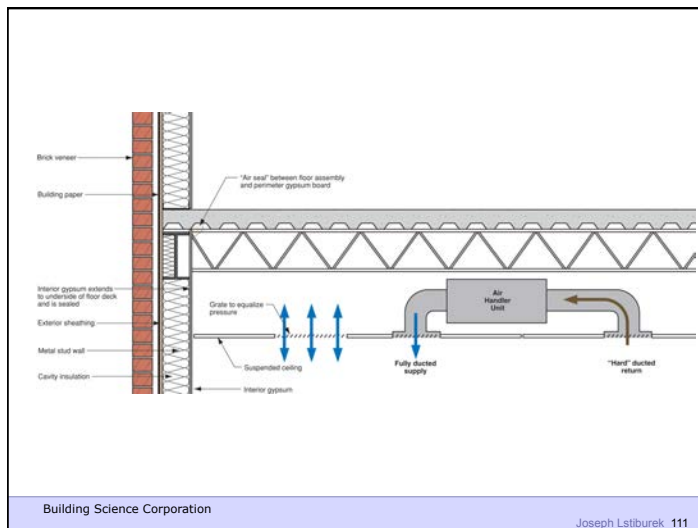

Building Science Corporation

Joseph Lstiburek 111

It's a Case of Black or White

Building Science Corporation

Joseph Lstiburek 112

It's a Case of Black or White
Arrhenius

Building Science Corporation Joseph Lstiburek 113

It's a Case of Black or White
Arrhenius
Every 10 degrees C – double the “badness”

Building Science Corporation Joseph Lstiburek 114

