

Joseph Lstiburek, Ph.D., P.Eng, ASHRAE Fellow

Building Science

Adventures In Building Science

www.buildingscience.com

Arrhenius Equation

Building Science Corporation

Joseph Lstiburek 2

For Every 10 Degree K Rise
Activation Energy Doubles

$$k = Ae^{-E_a/(RT)}$$

Damage Functions
Water
Heat
Ultra-violet Radiation

Vapor Pressure and Relative Humidity

Building Science Corporation

Joseph Lstiburek 5

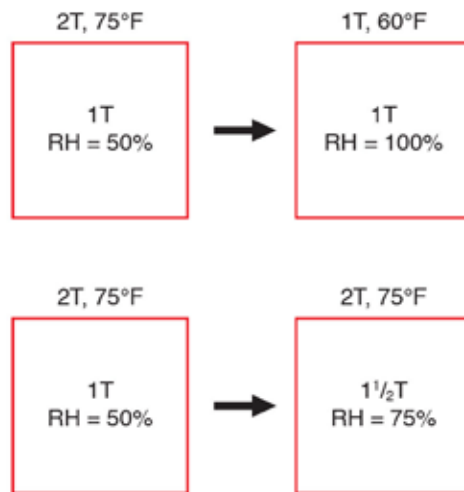

Building Science Corporation

Joseph Lstiburek 6

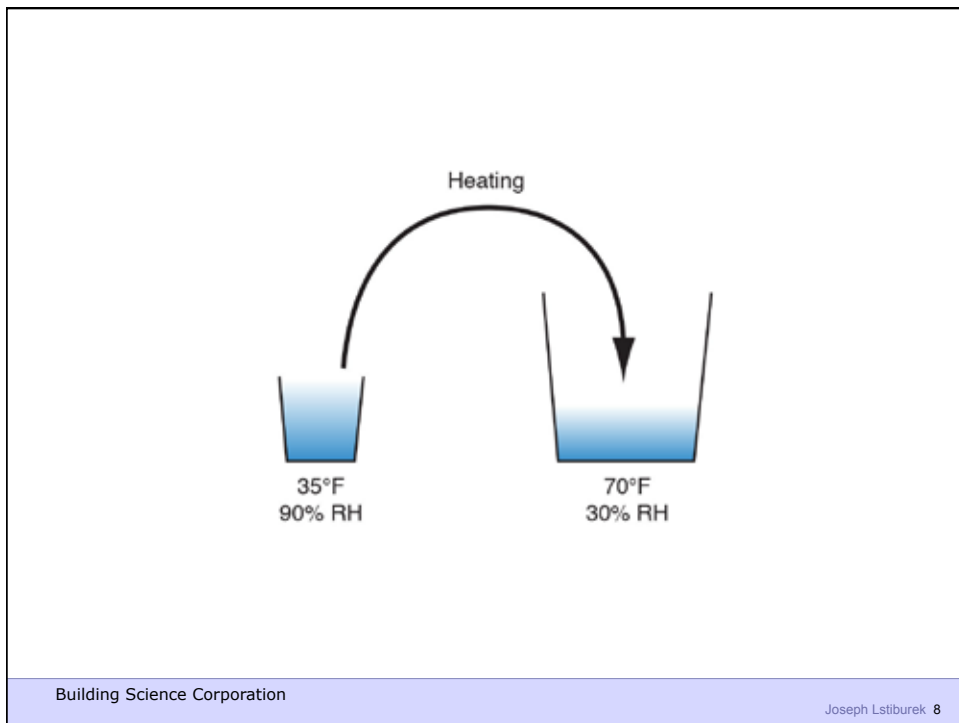
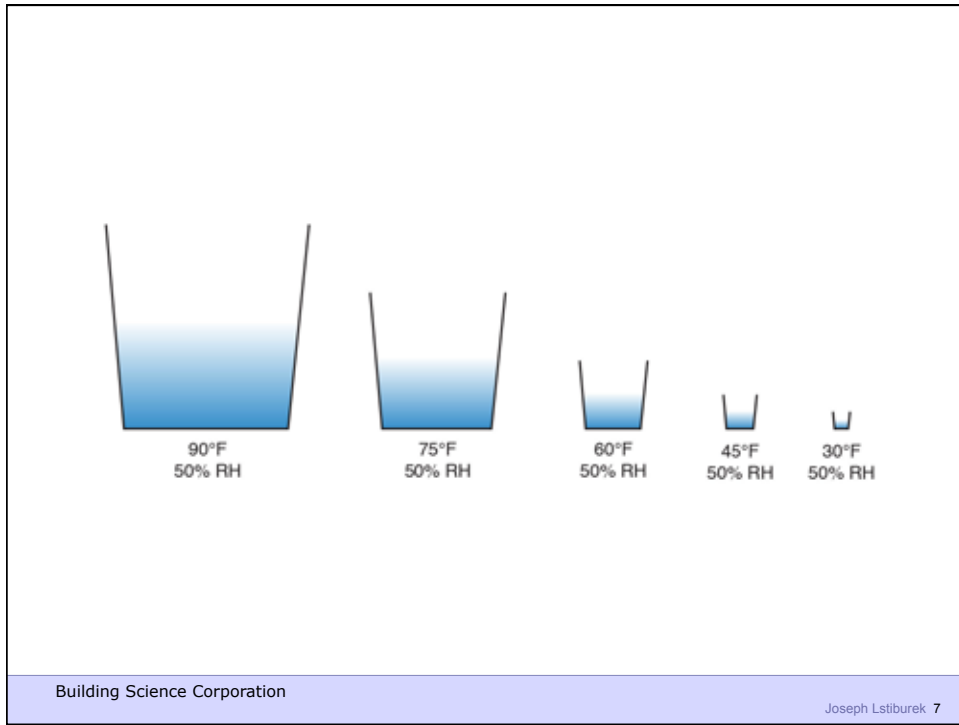

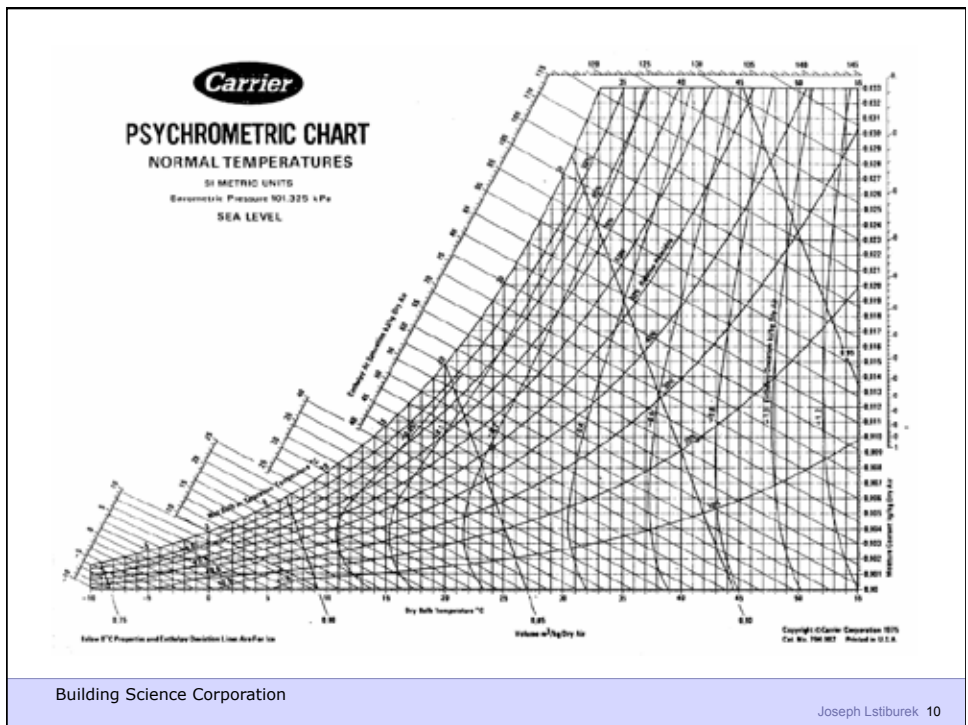
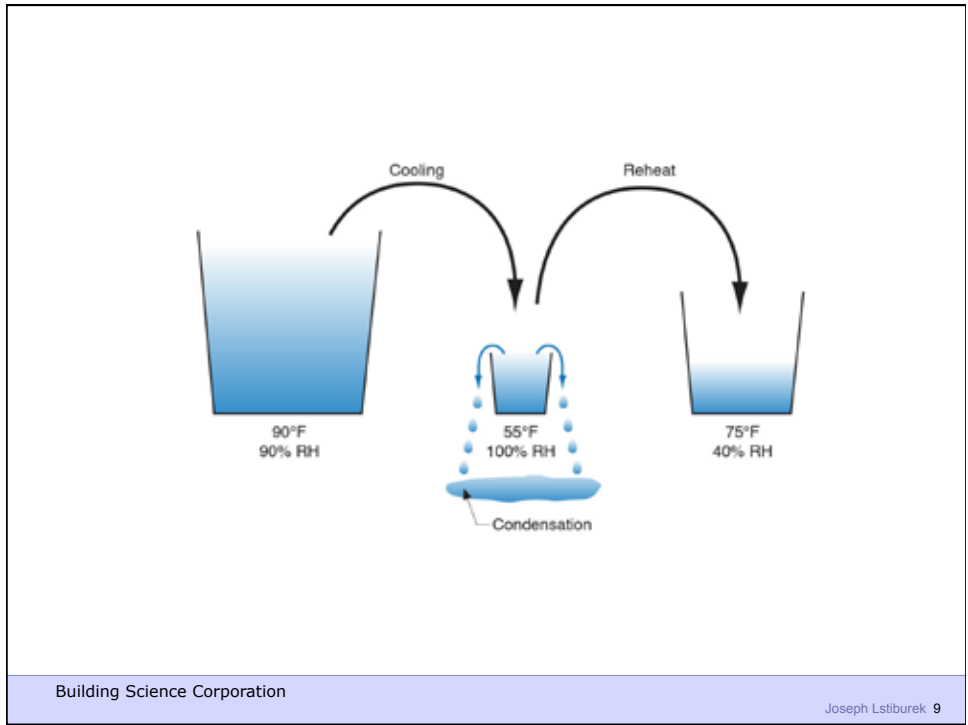

Sorption Isotherms

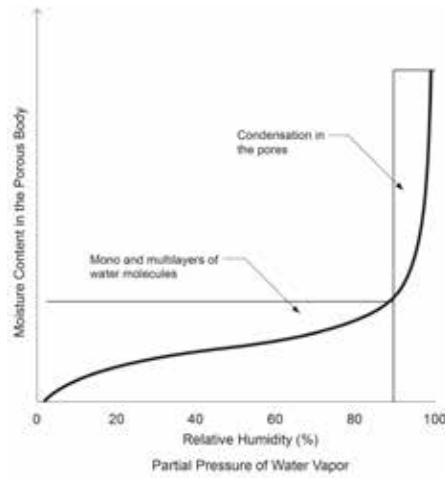

Change in the storage of moisture in a porous building material as the partial pressure of water vapor in the ambient air increases from zero to full saturation value at a given temperature.

Sorption Curve
From M.K. Kumaran, ASTM MN, 16-2nd Edition,
Moisture Control in Buildings, 2009

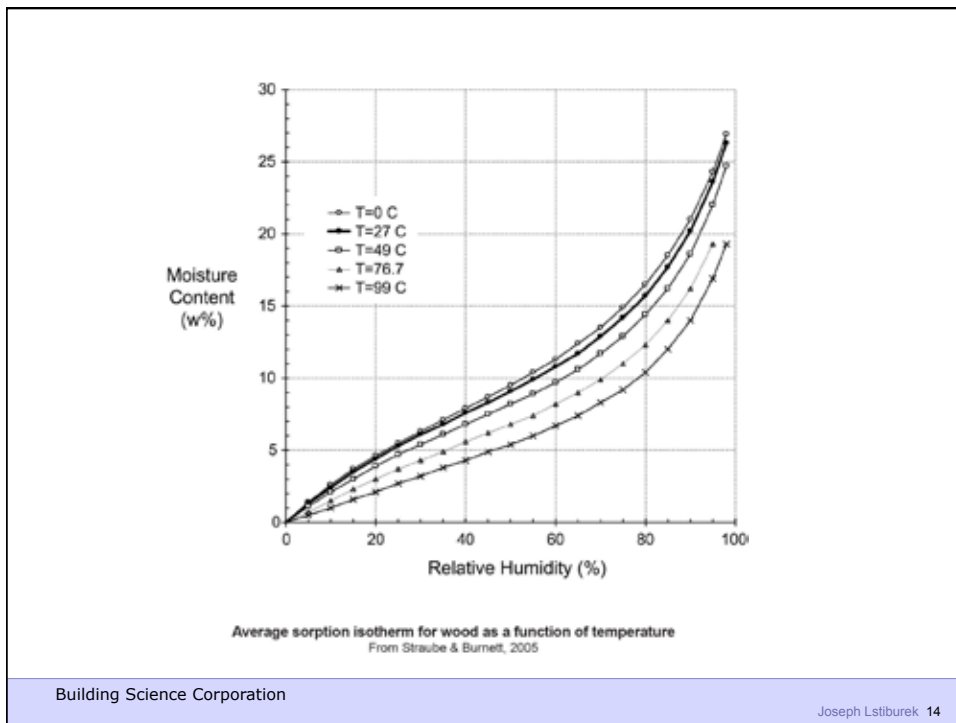
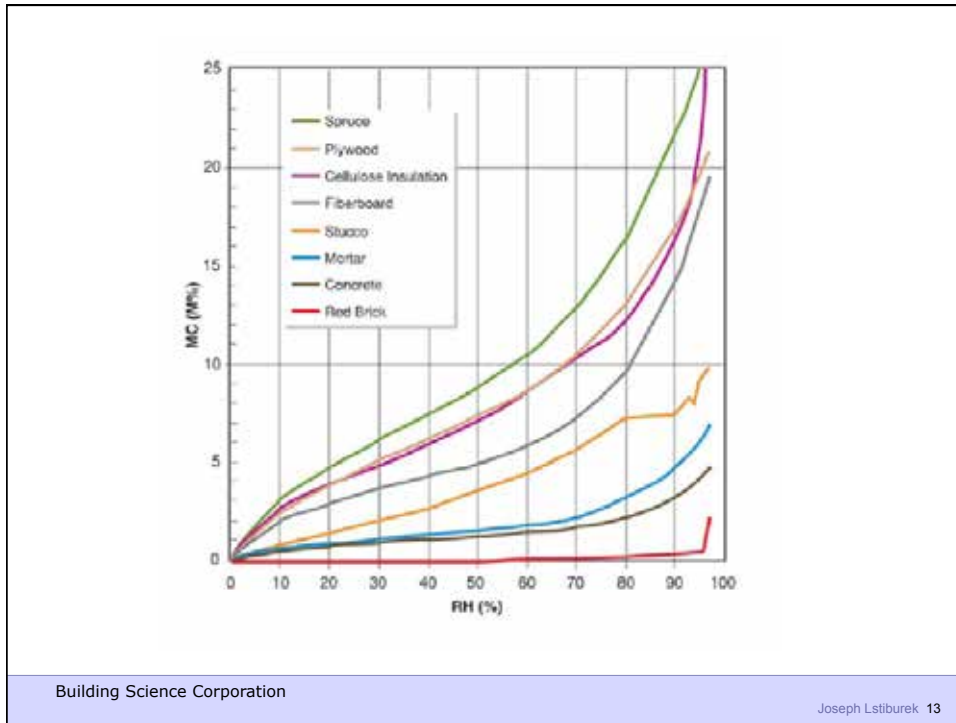

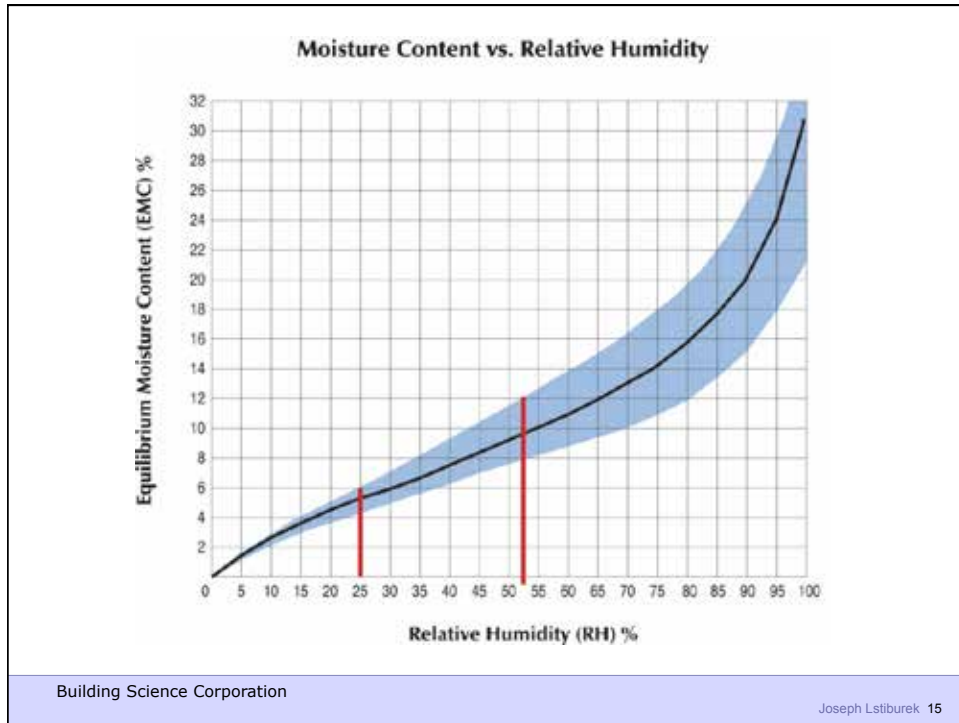

2nd Law of Thermodynamics

Building Science Corporation Joseph Lstiburek 16

Heat Flow Is From Warm To Cold
Moisture Flow Is From Warm To Cold
Moisture Flow Is From More To Less
Air Flow Is From A Higher Pressure to a
Lower Pressure
Gravity Acts Down



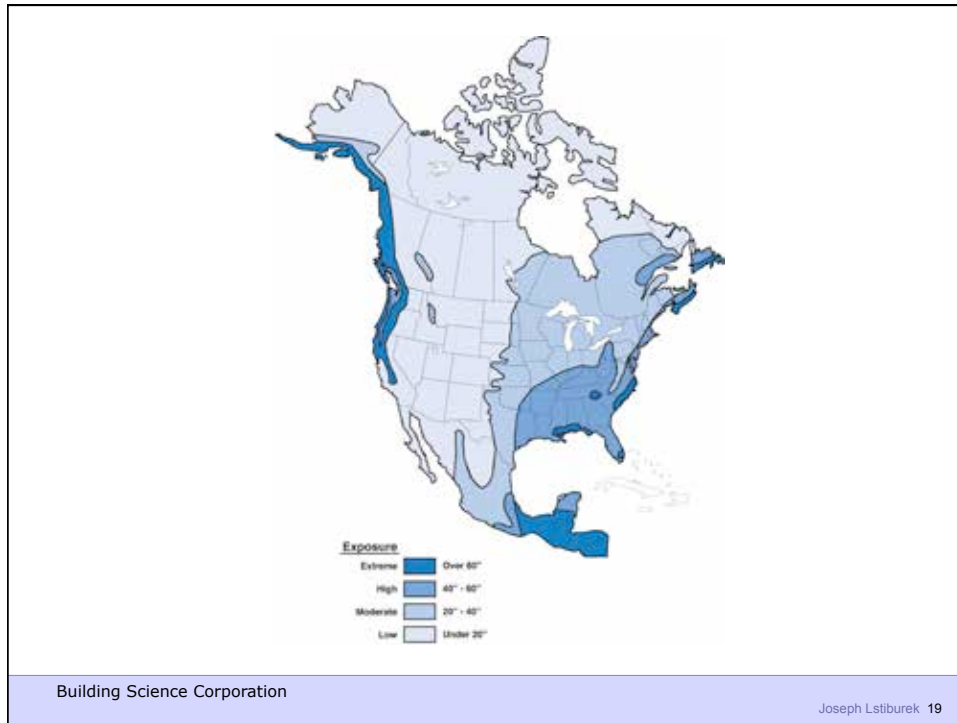

Vented Attics Are Climate Dependant

Building Science Corporation

Joseph Lstiburek 20

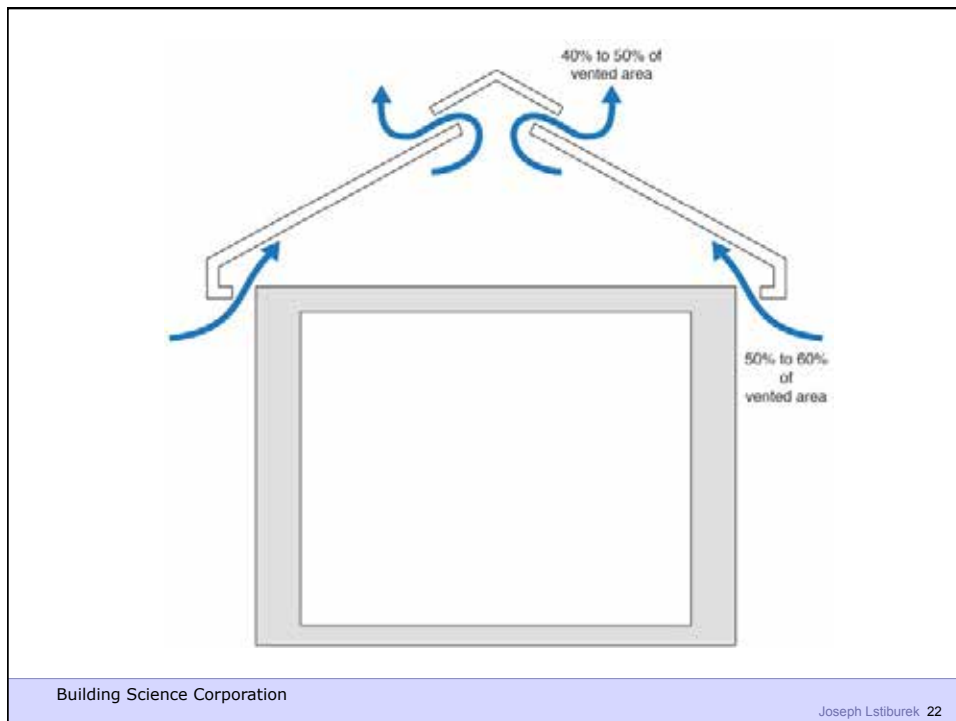
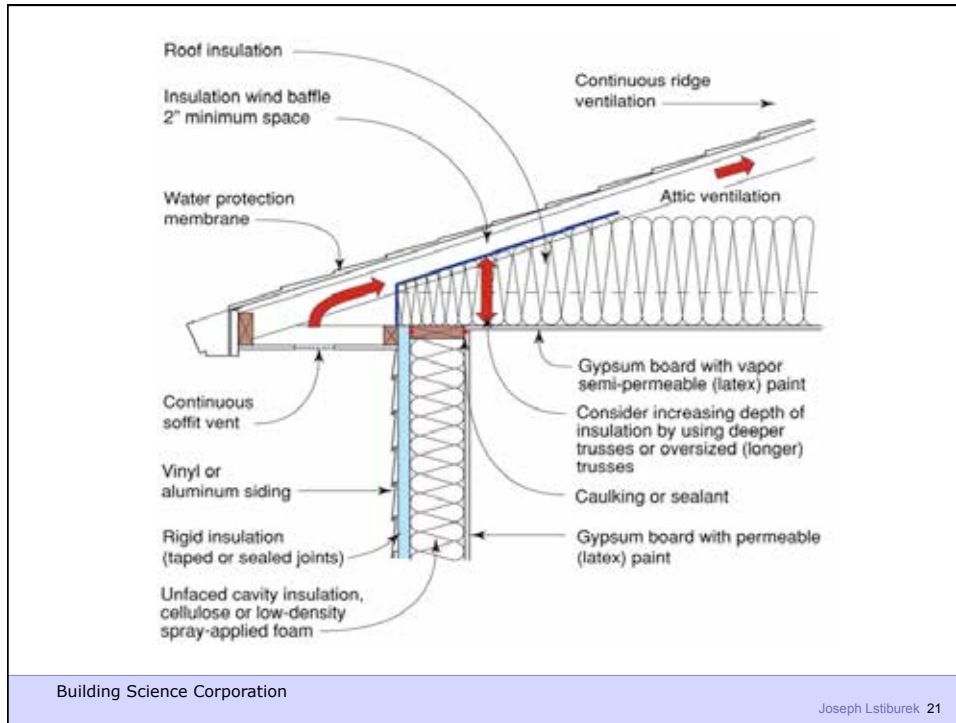

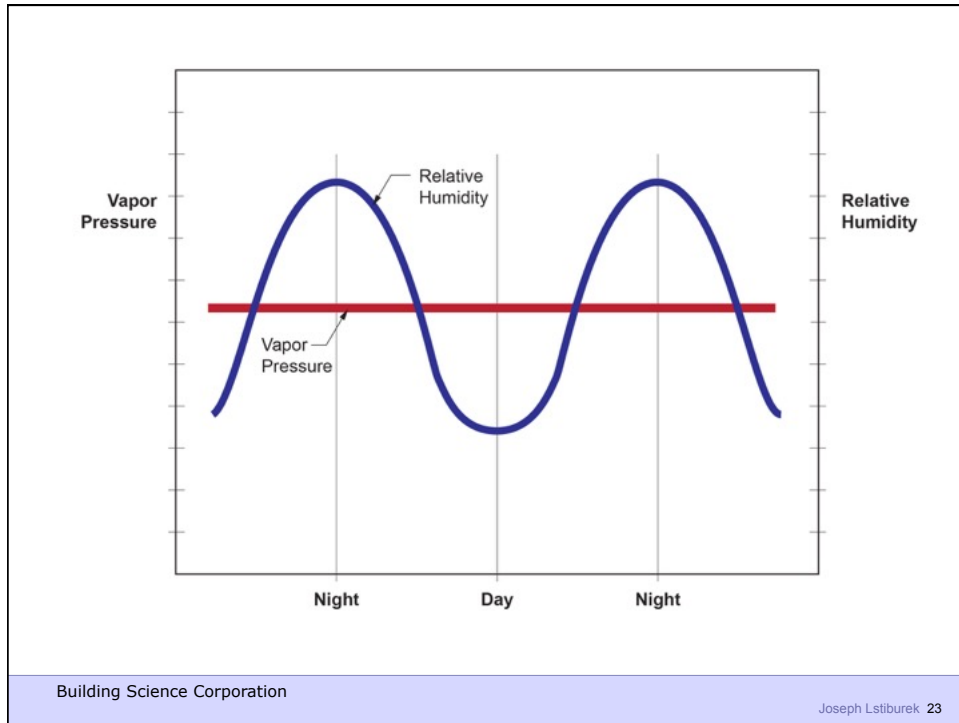

Enclosures

Building Science Corporation

Joseph Lstiburek 24

Water Control Layer
Air Control Layer
Vapor Control Layer
Thermal Control Layer

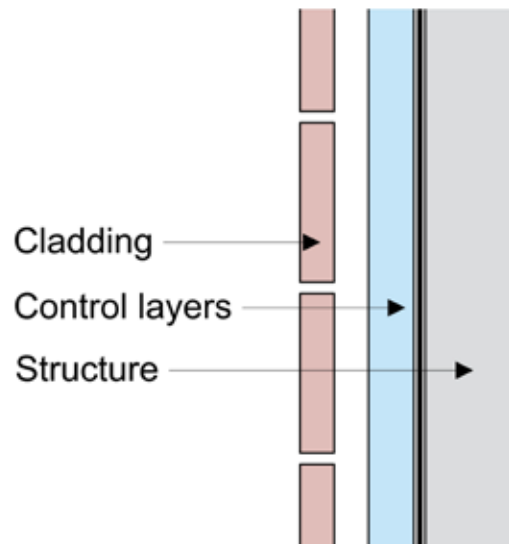

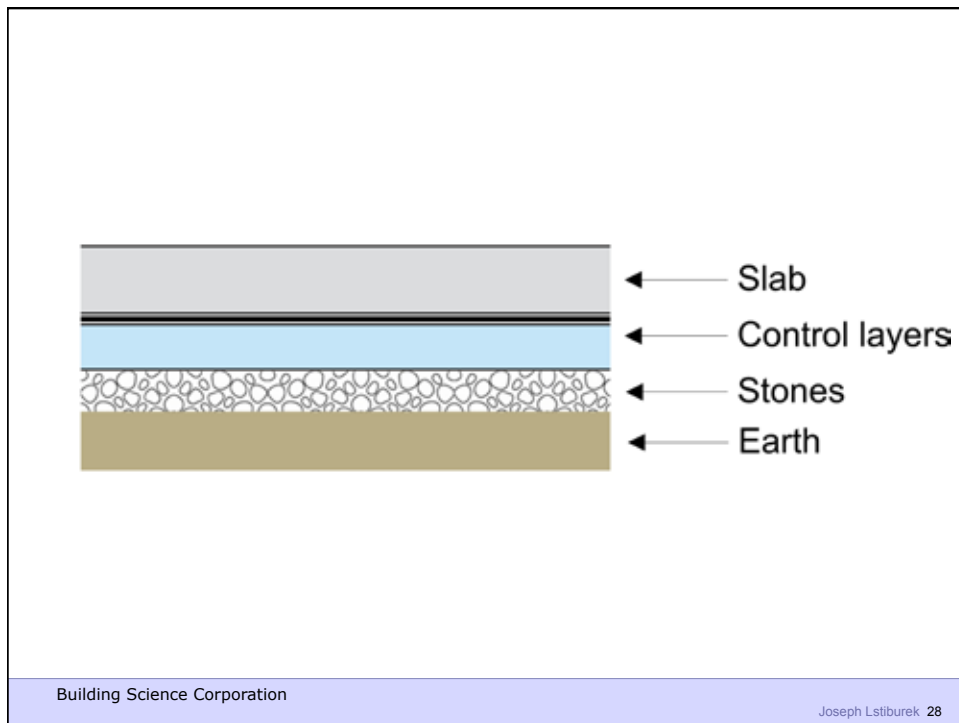
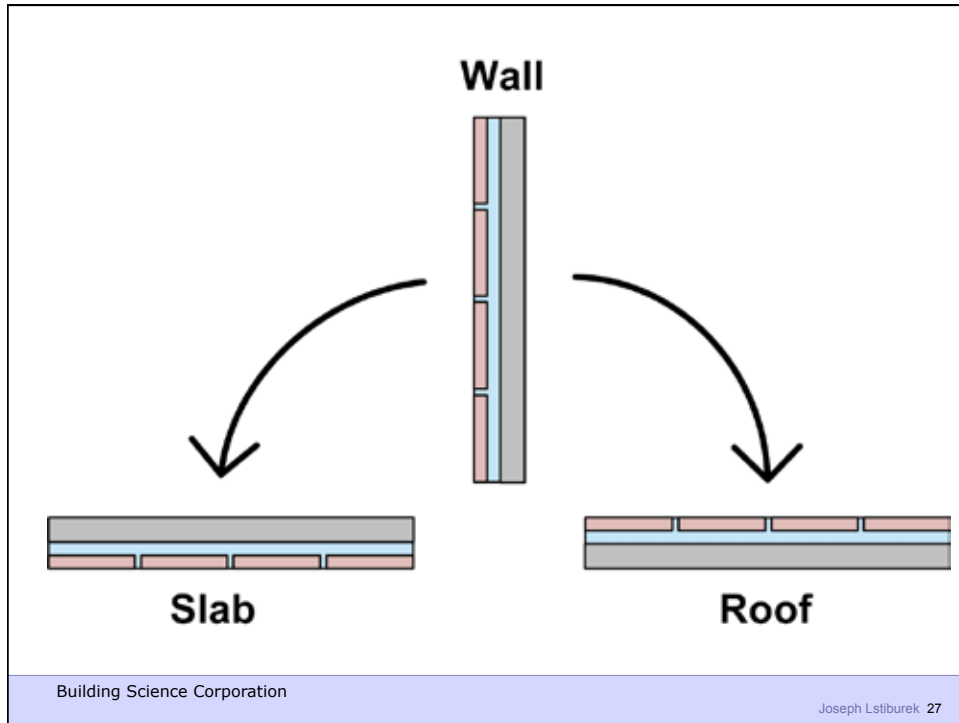

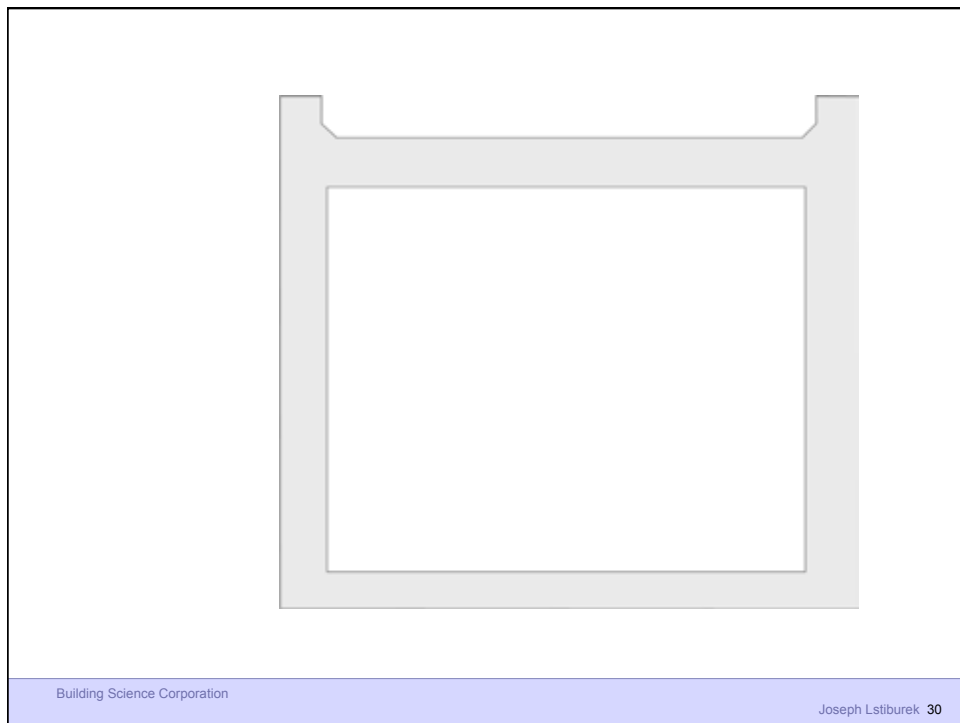
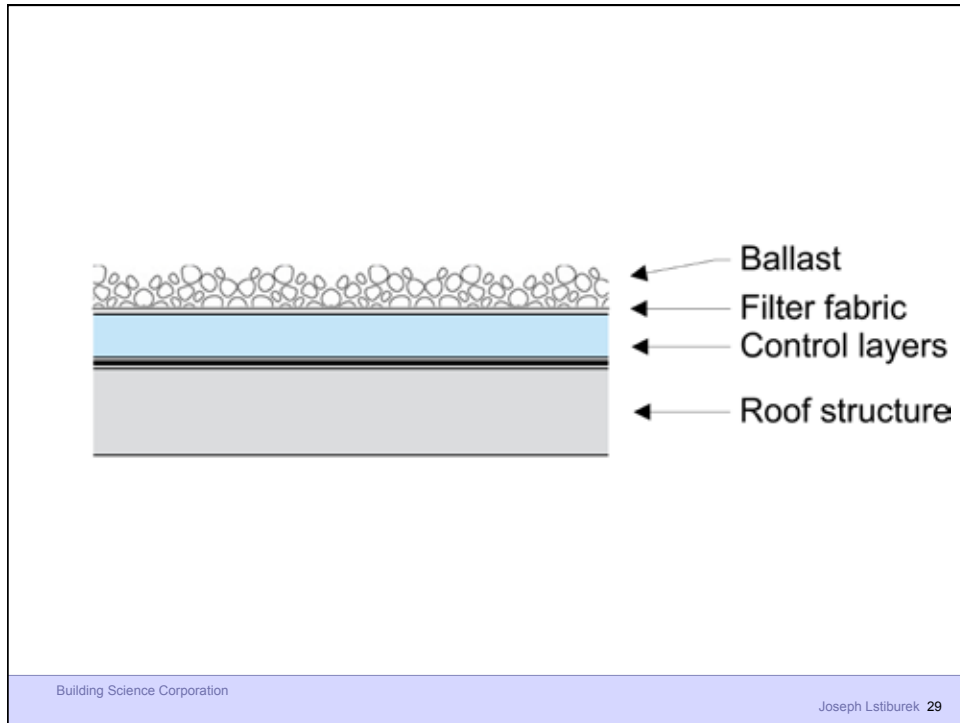

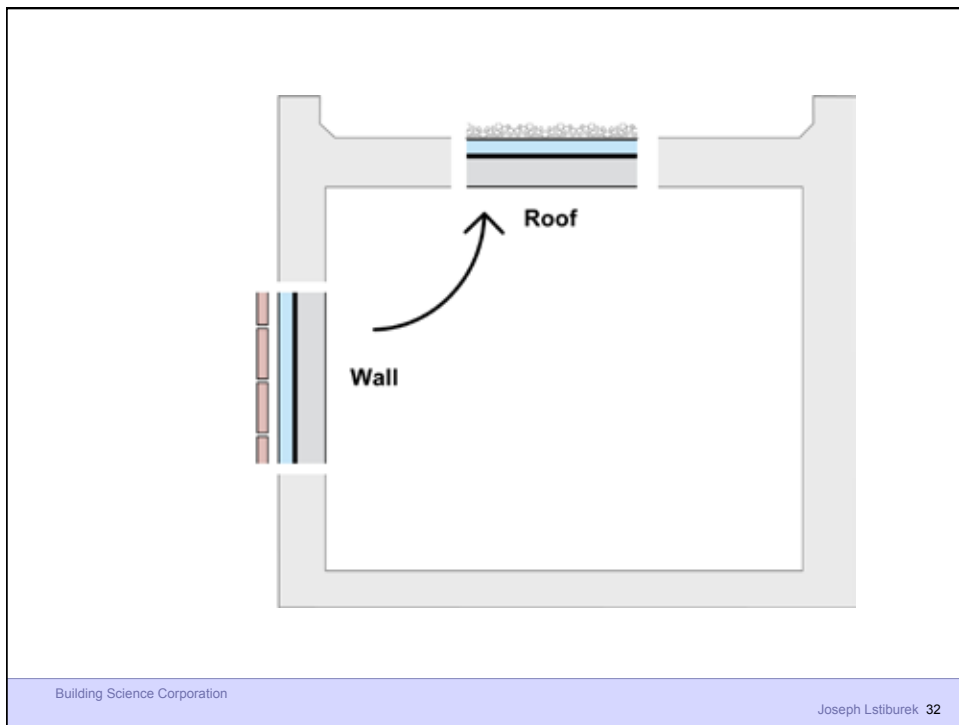
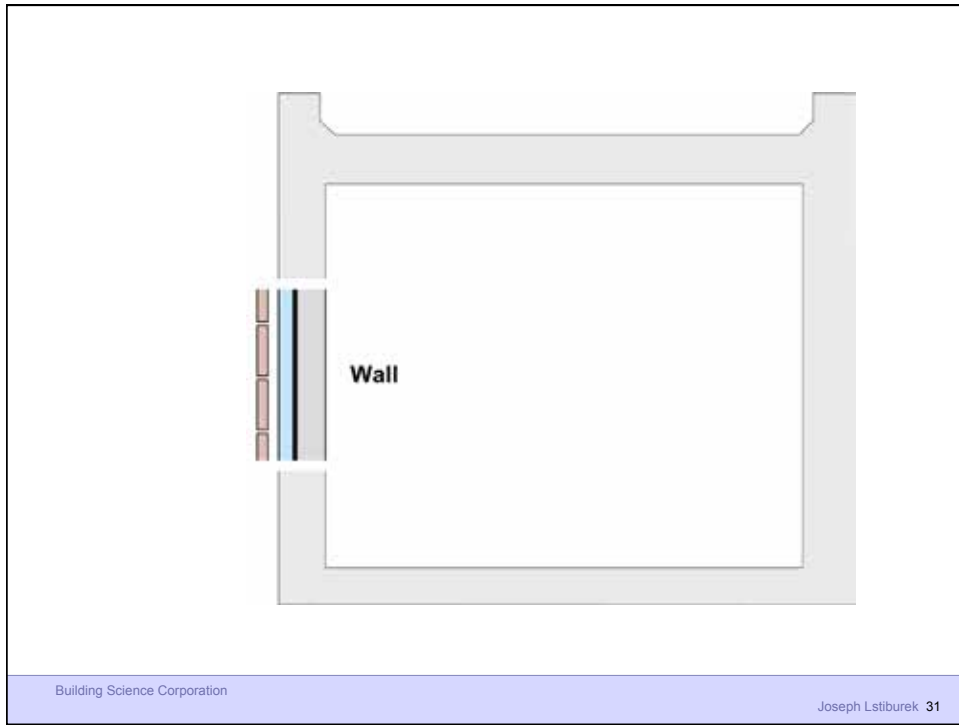

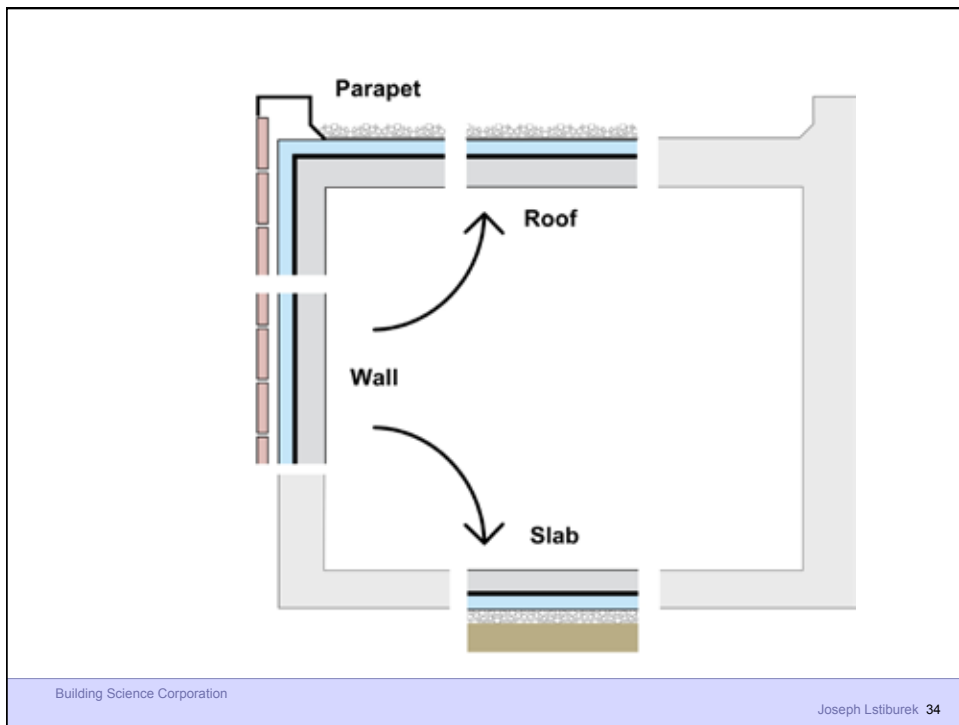
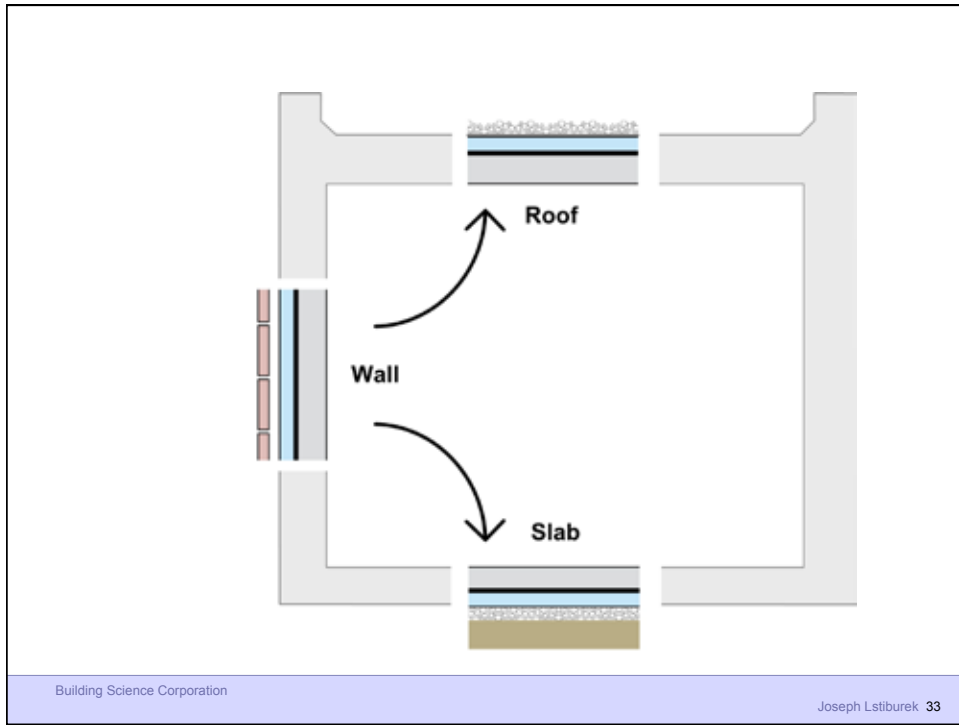

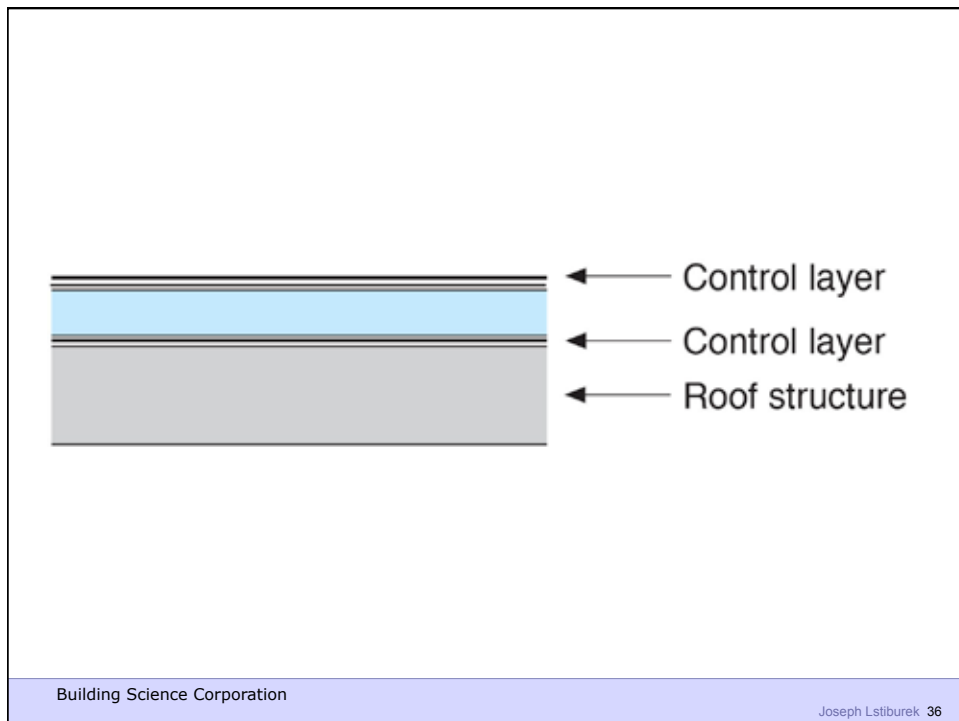
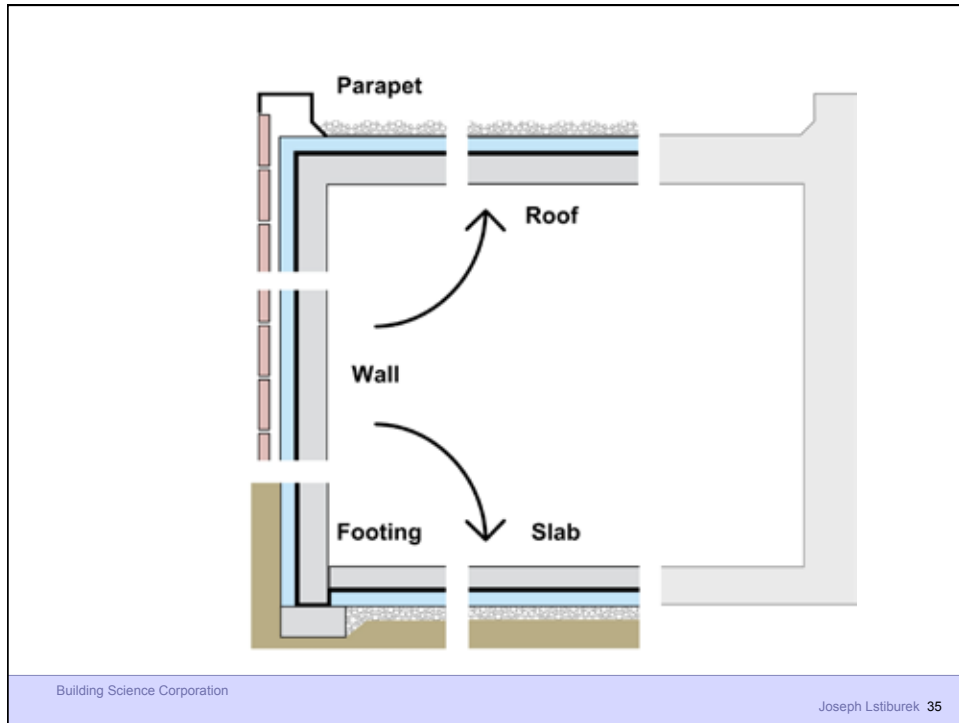

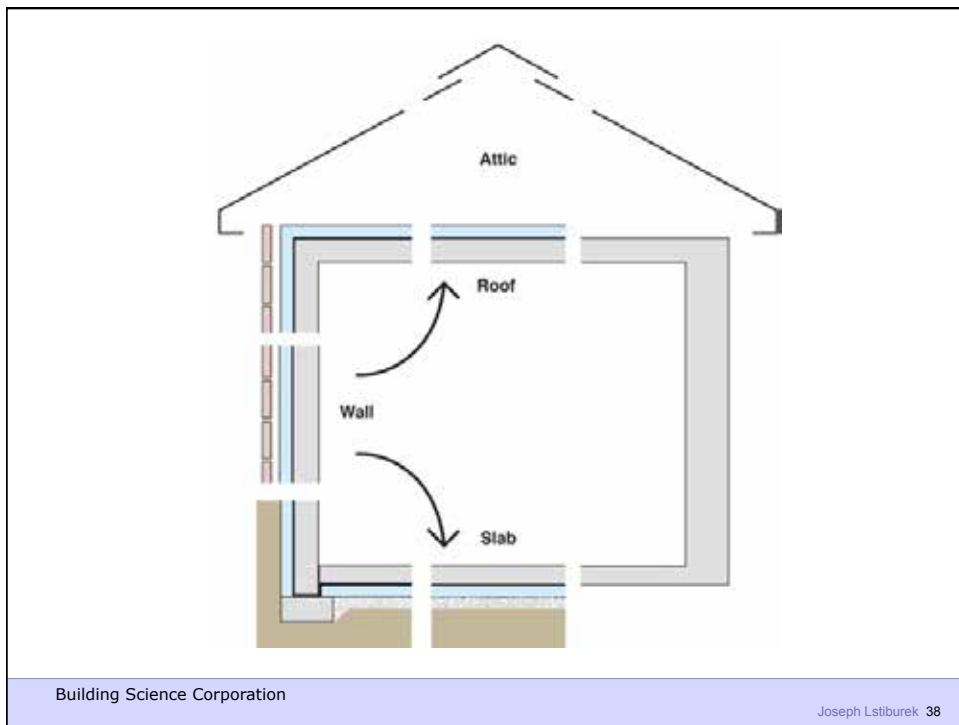
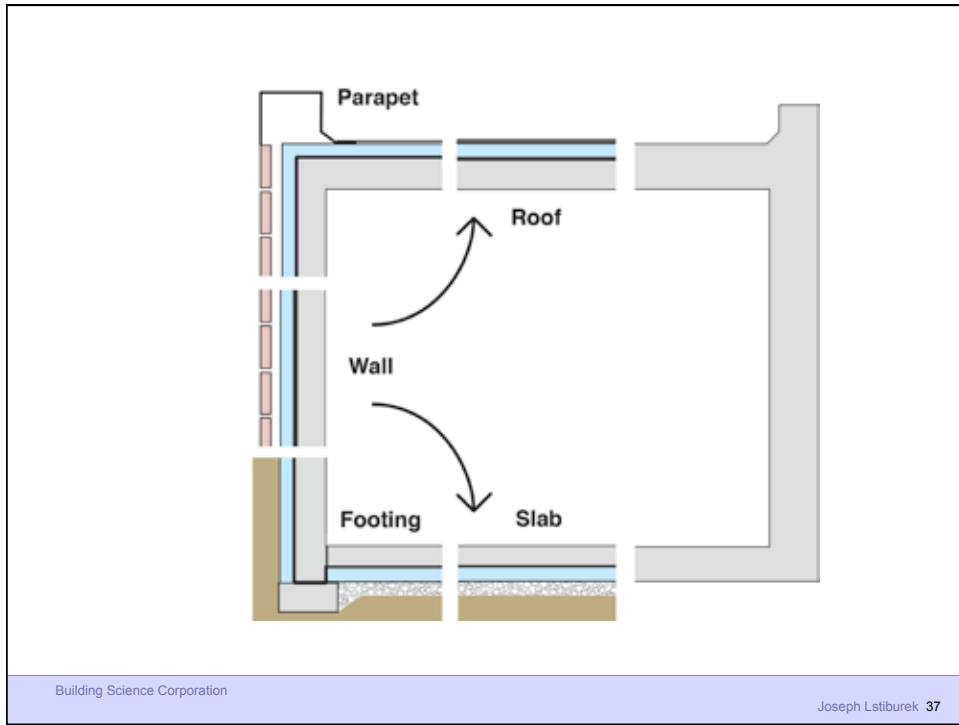

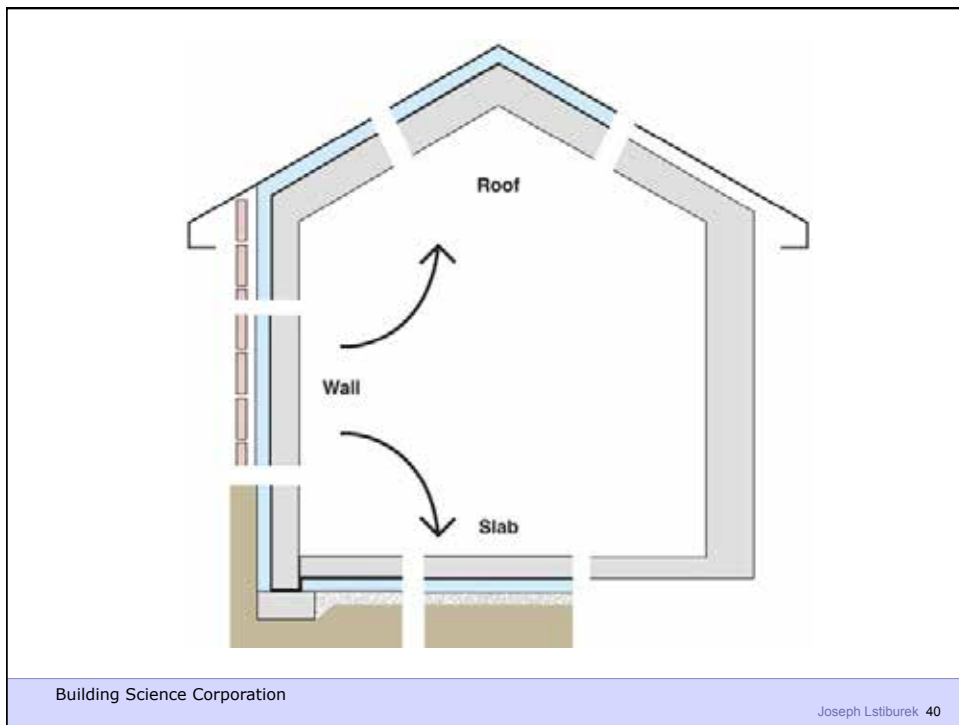
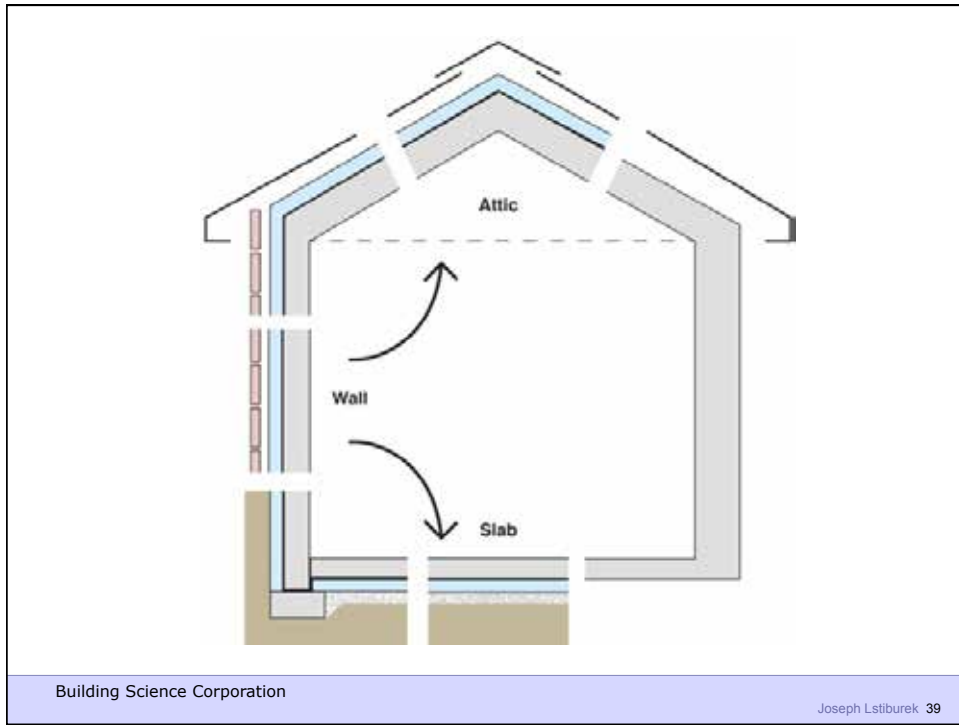

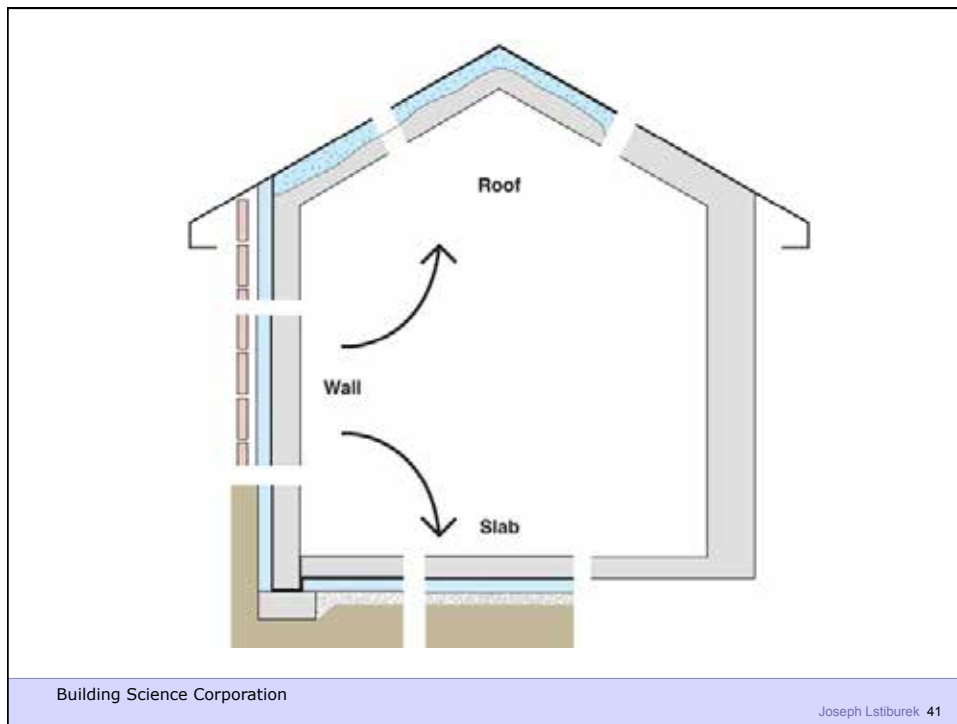

Houses With Vented Attics Suck

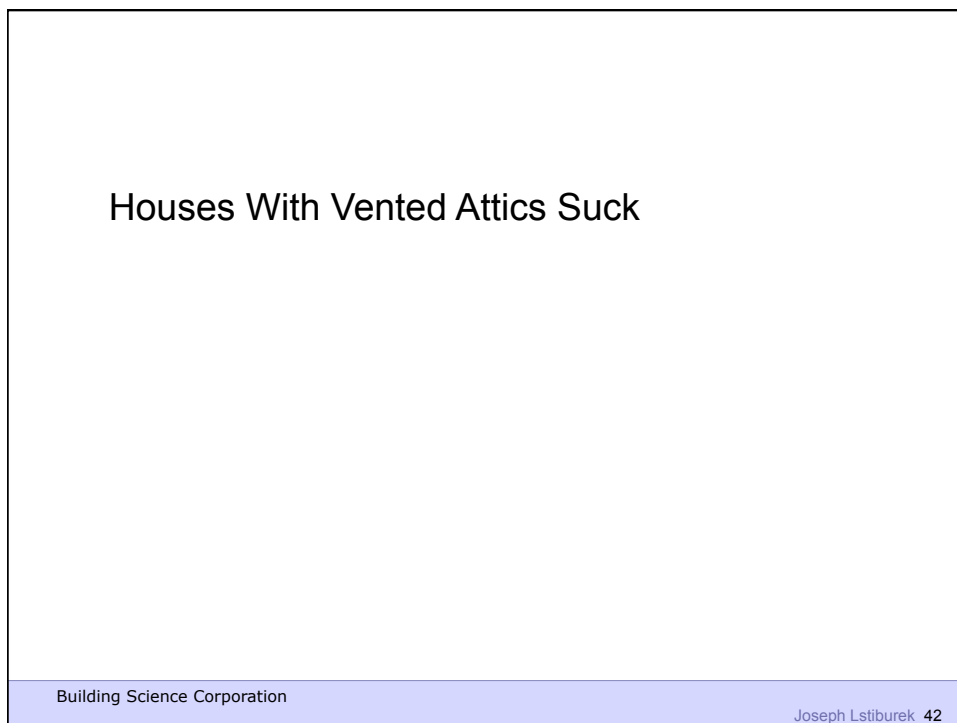

Houses With Vented Attics Suck Not all the Time.....but.....

Building Science Corporation

Joseph Lstiburek 43



Building Science Corporation

Joseph Lstiburek 44



Building Science Corporation

Joseph Lstiburek 45

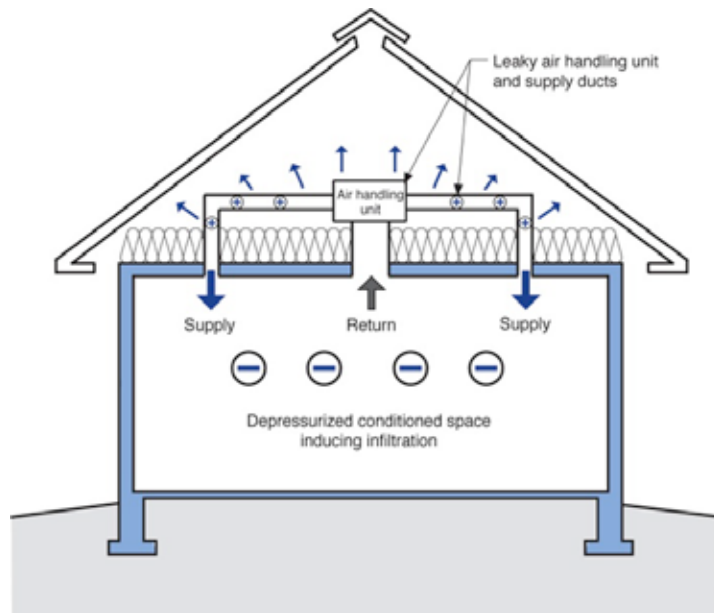

Building Science Corporation

Joseph Lstiburek 46

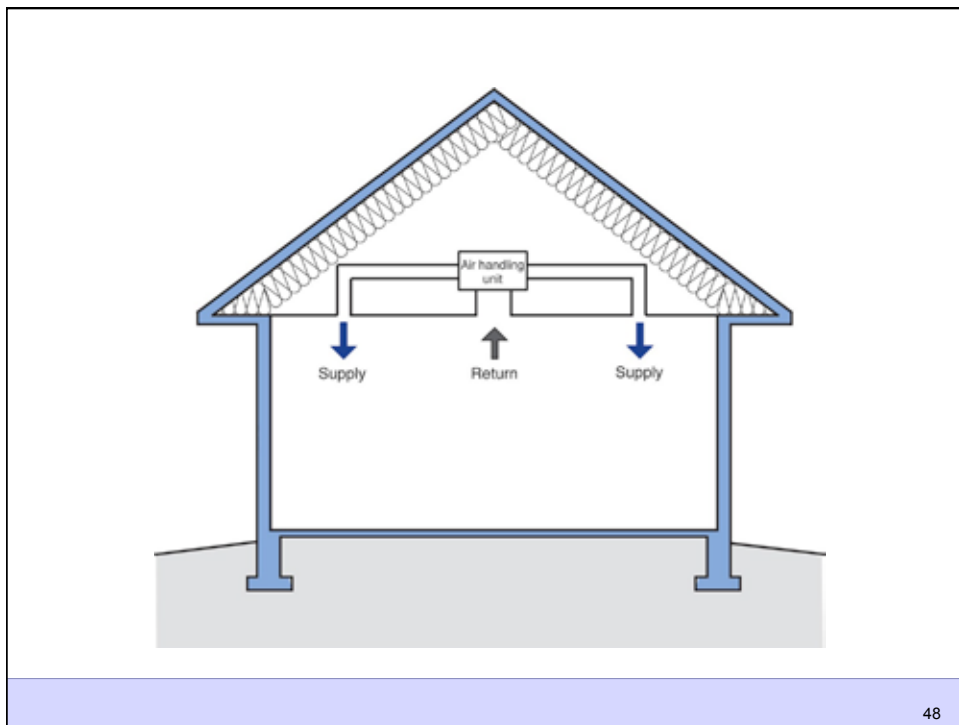
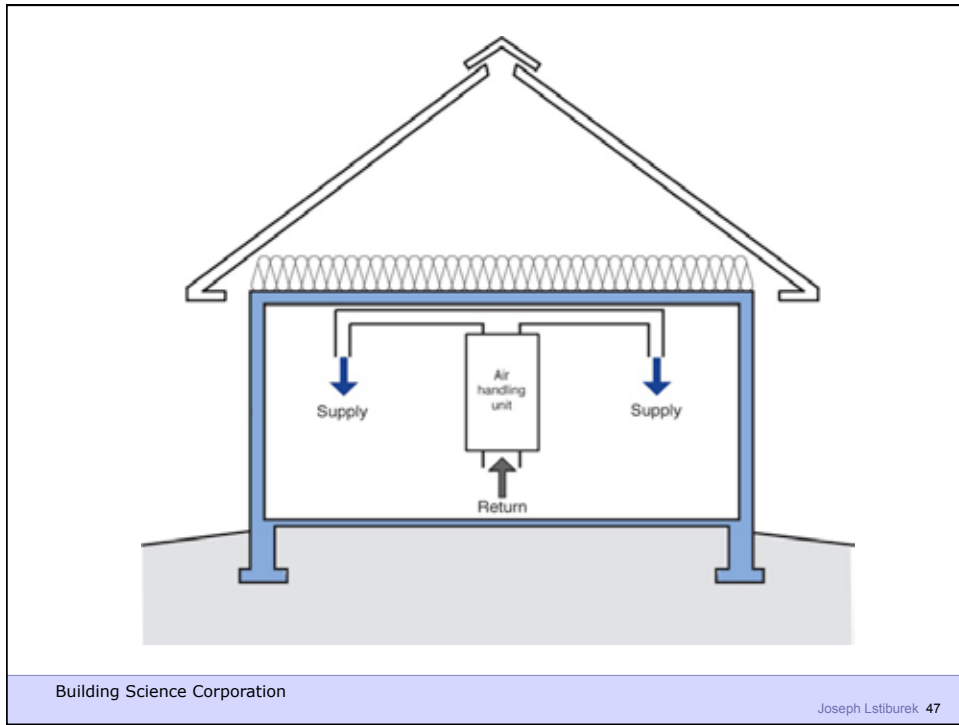



Building Science Corporation

Joseph Lstiburek 49



50

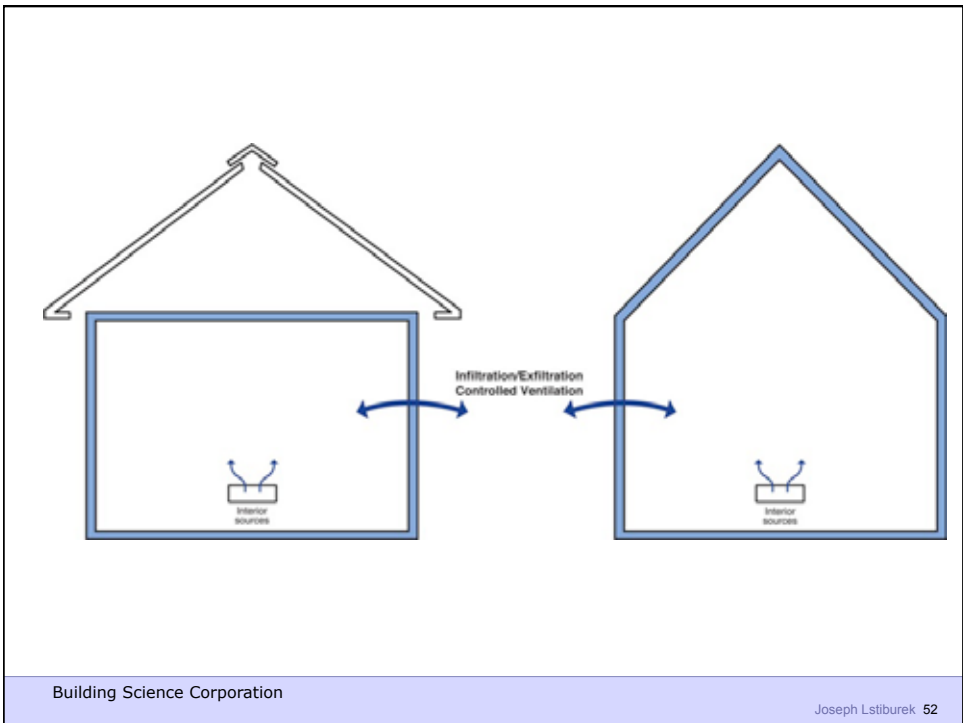
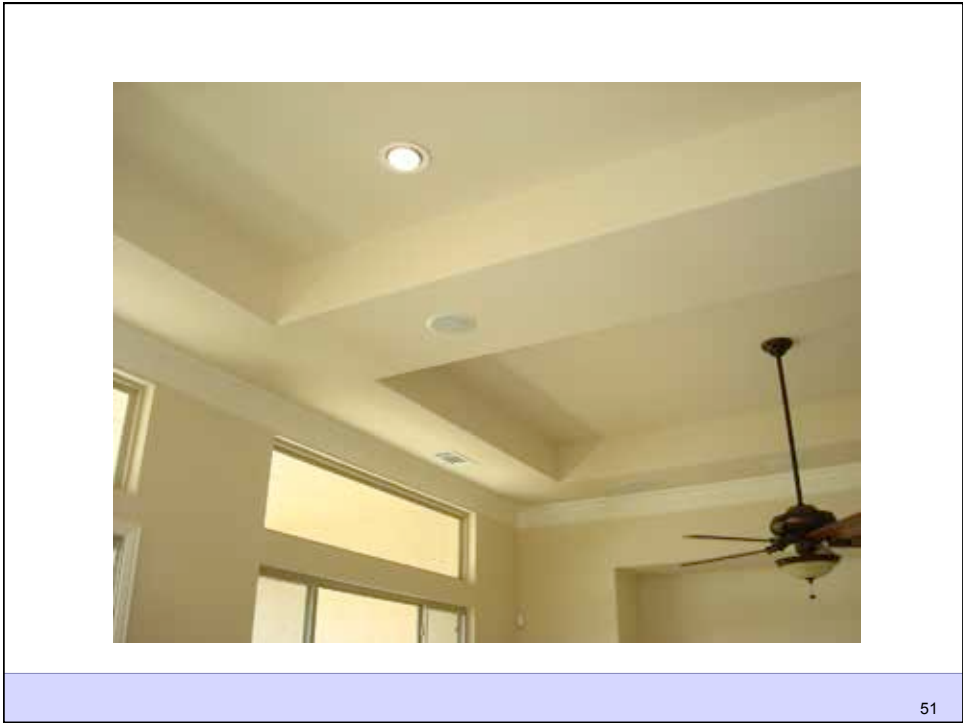

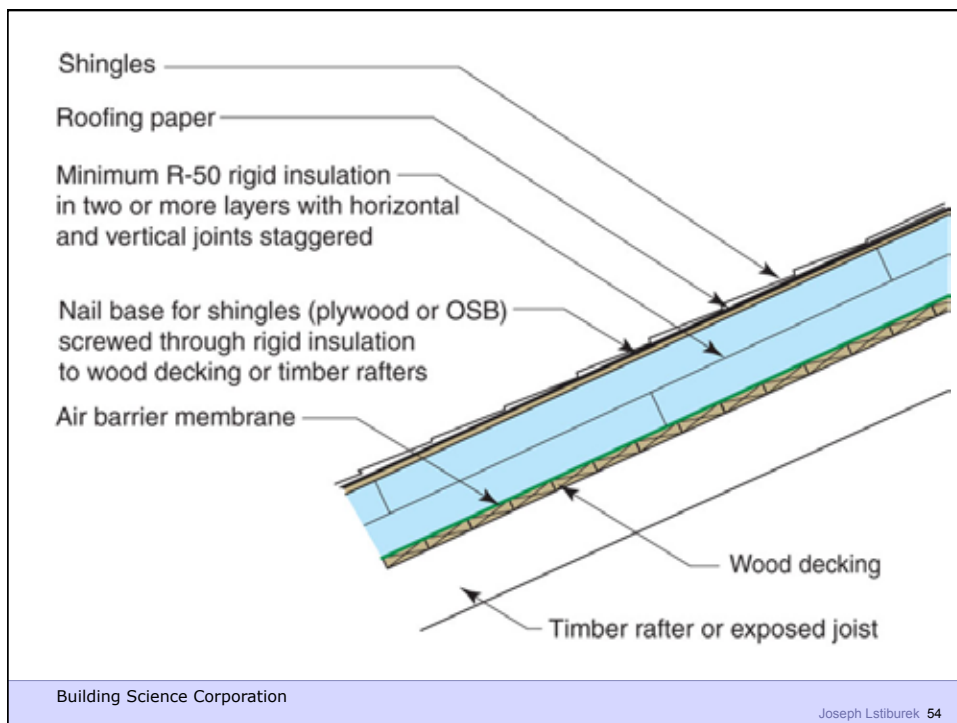
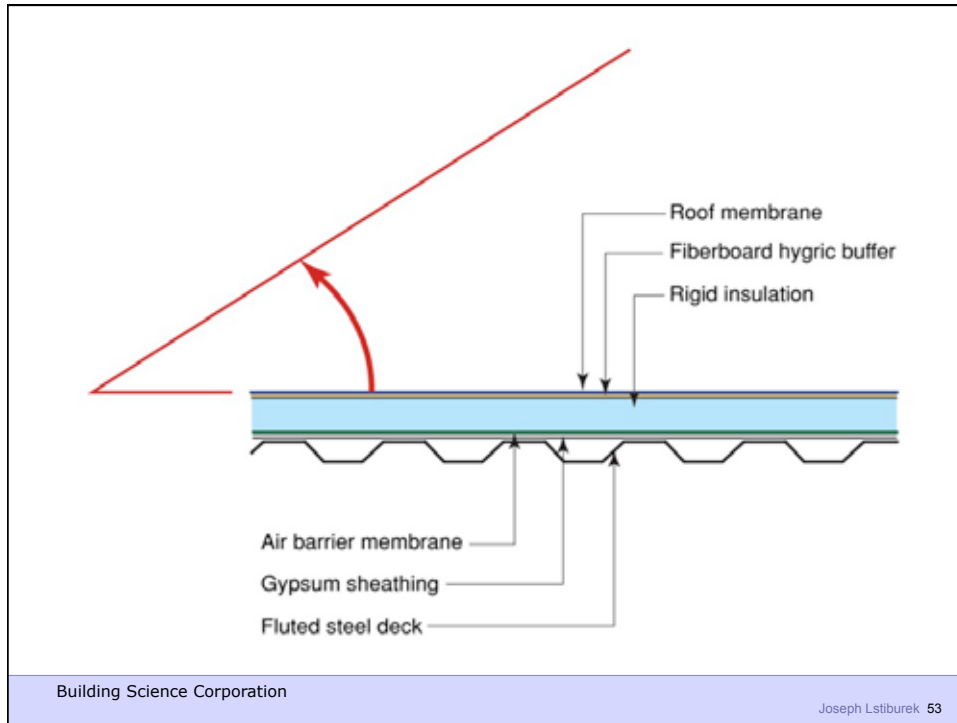

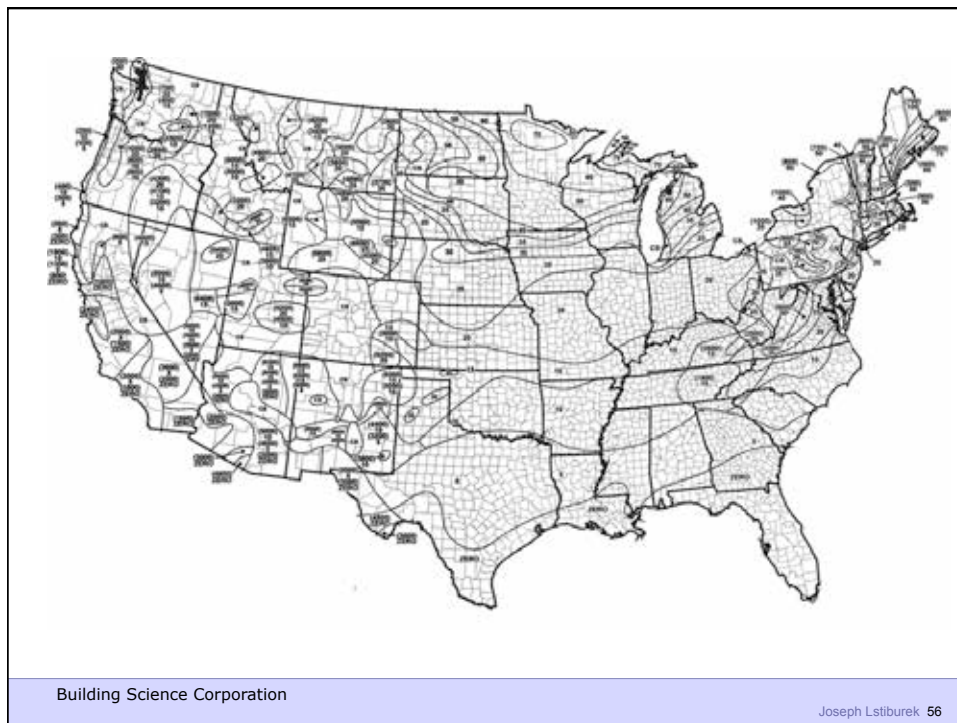
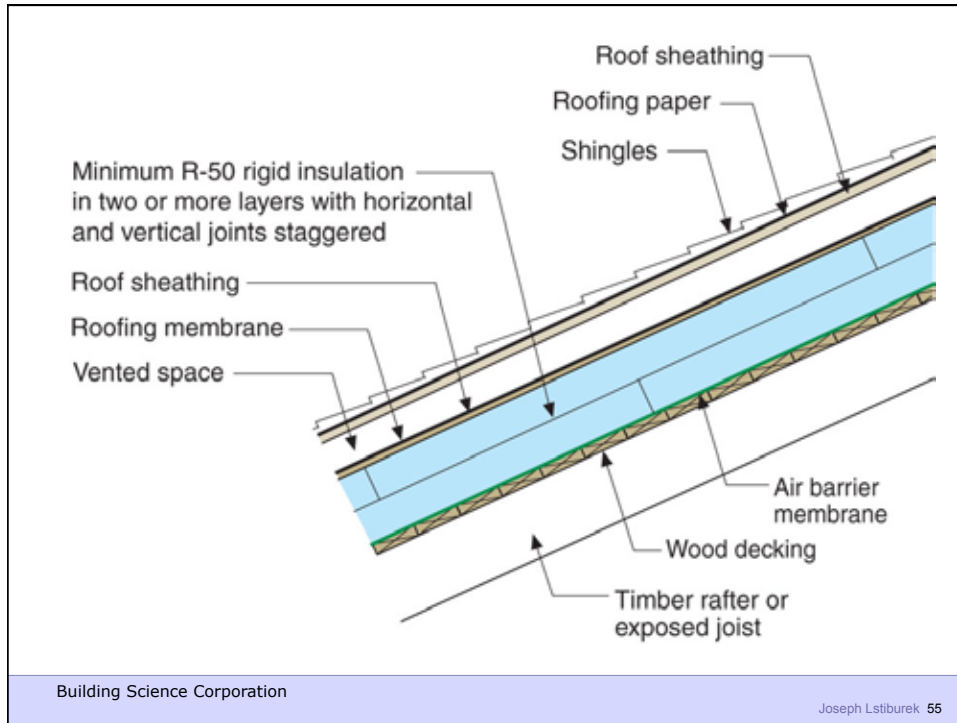

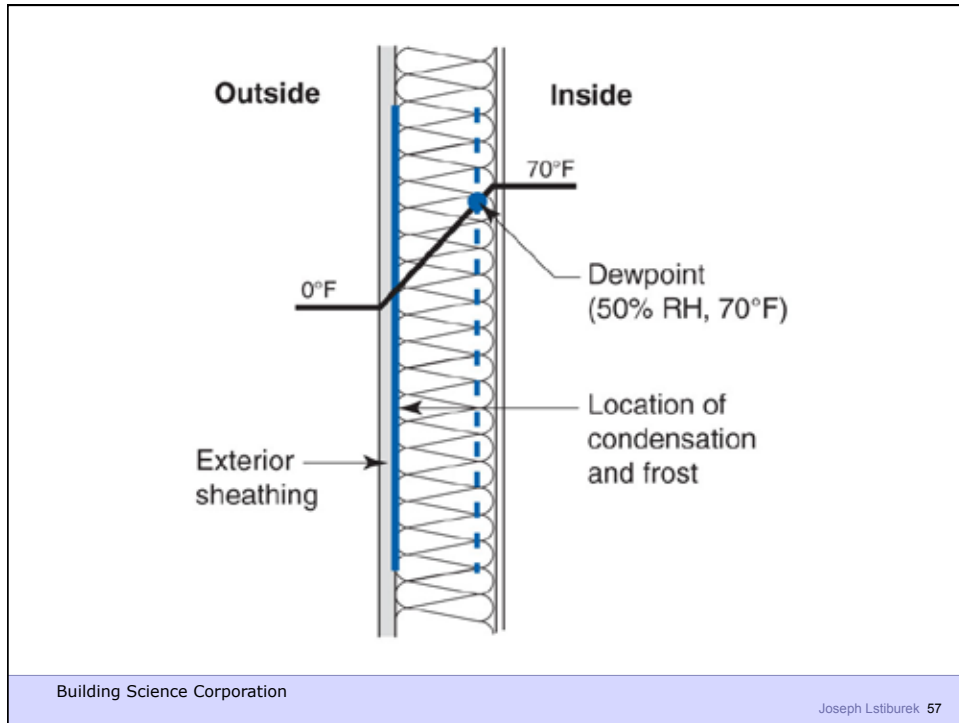

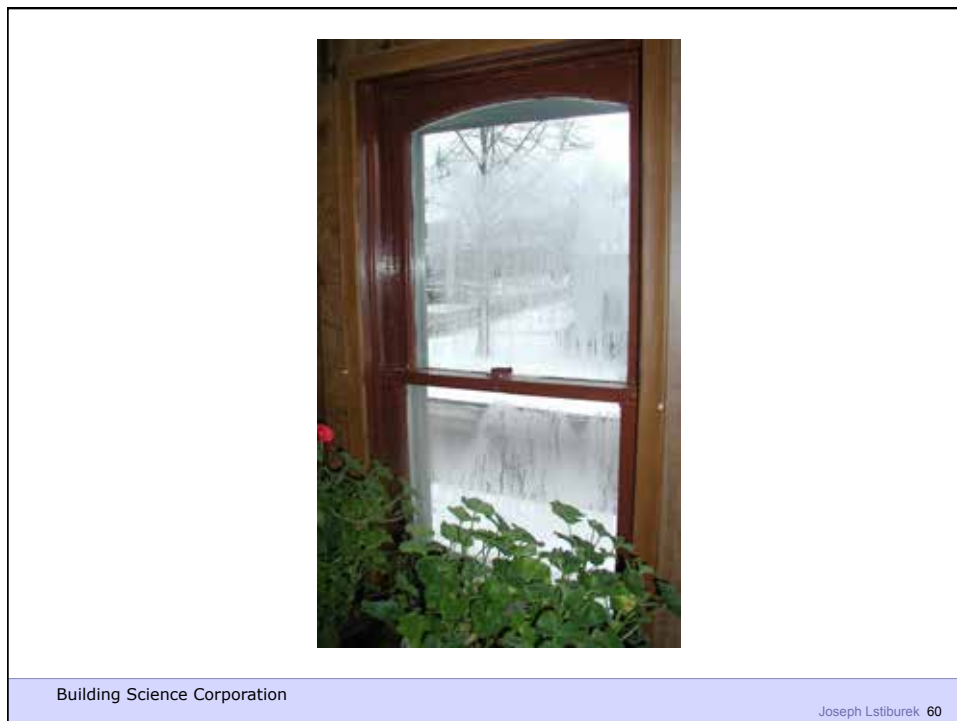
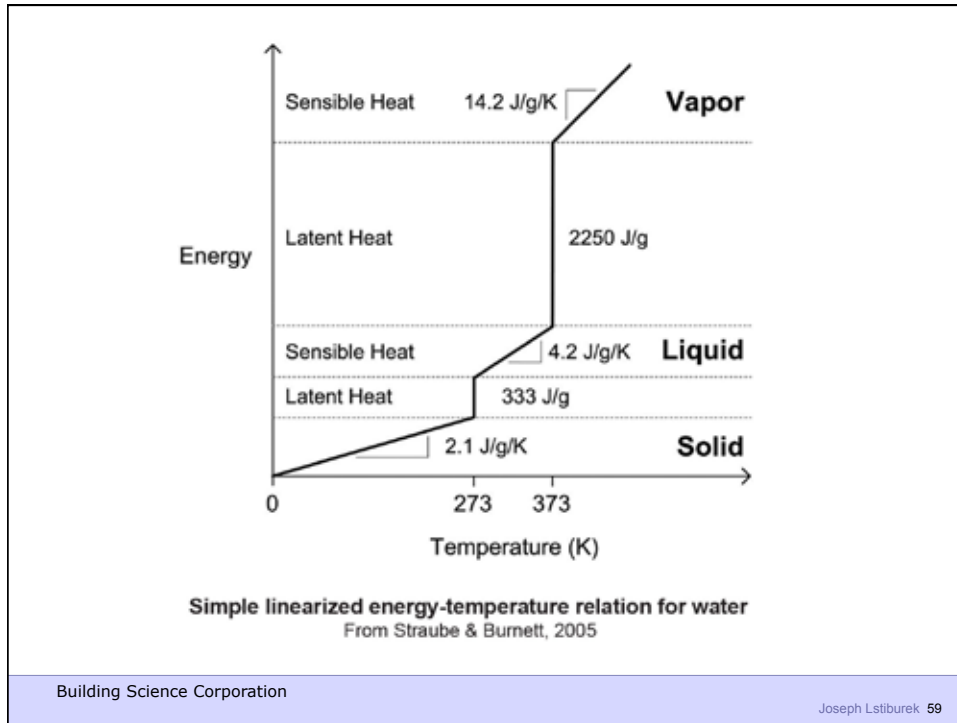

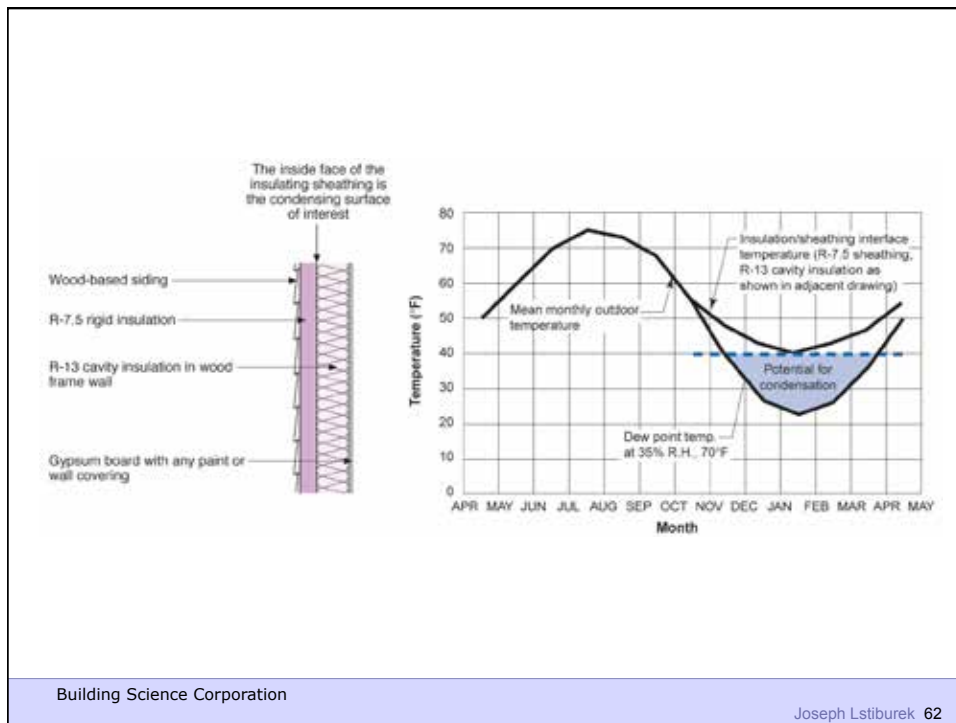
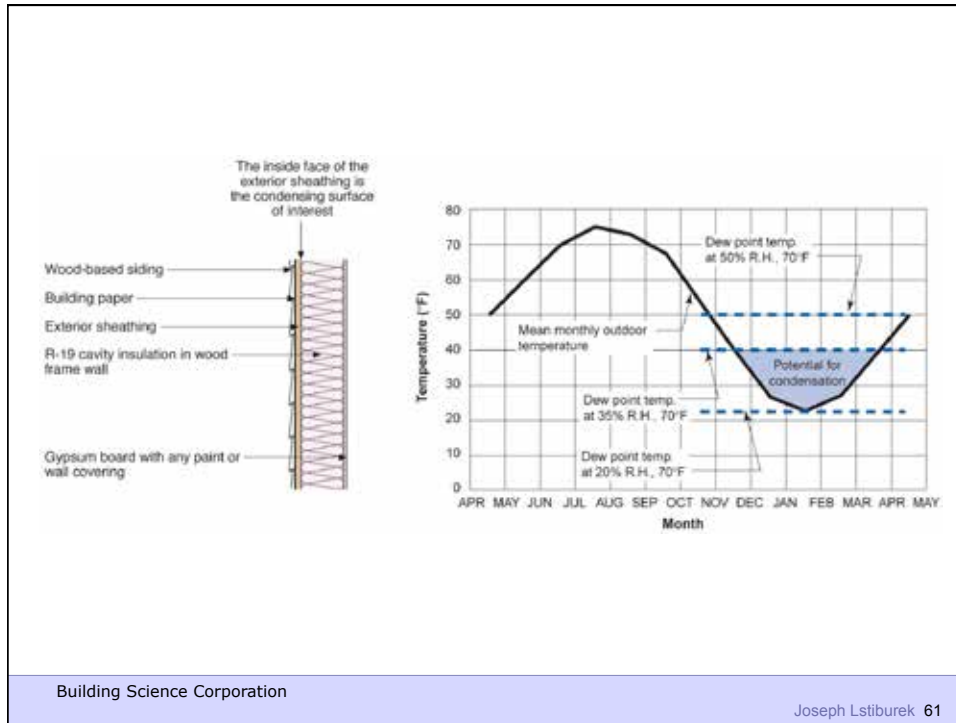

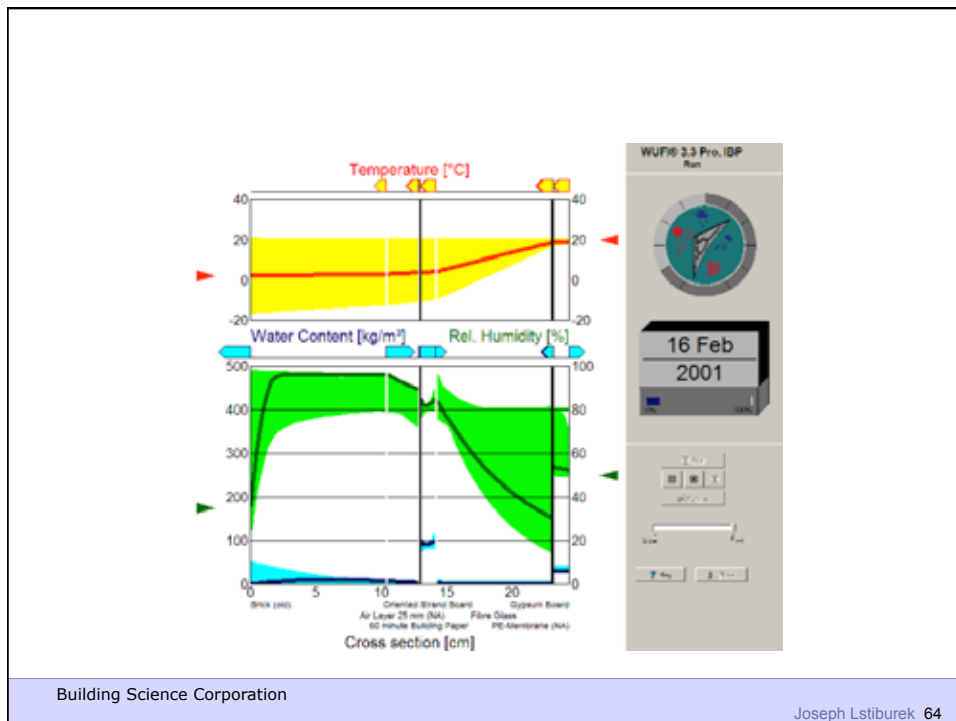
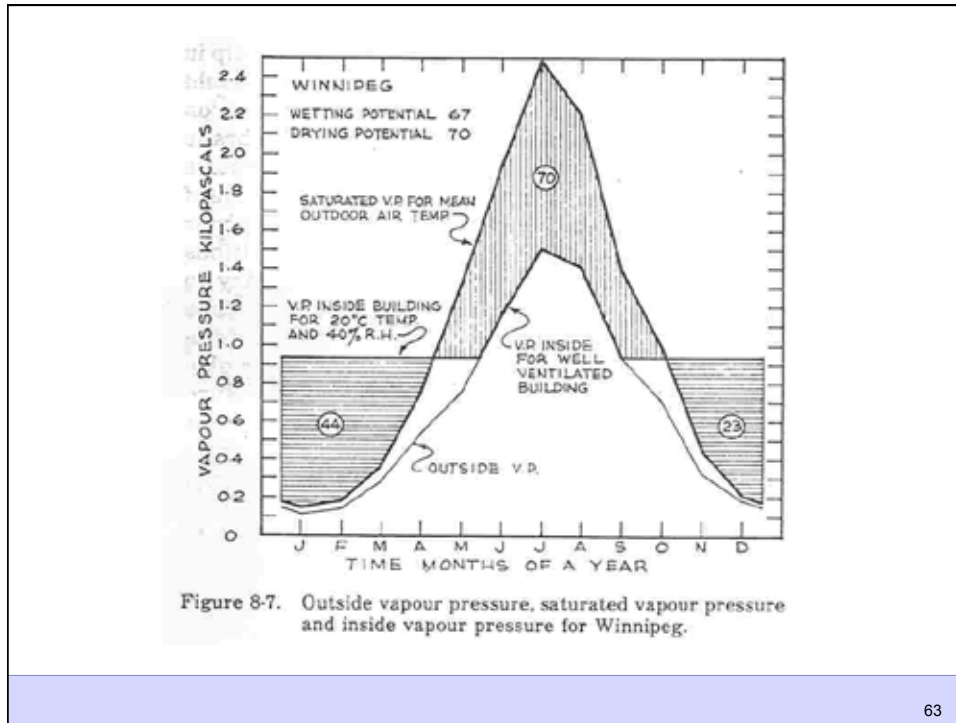

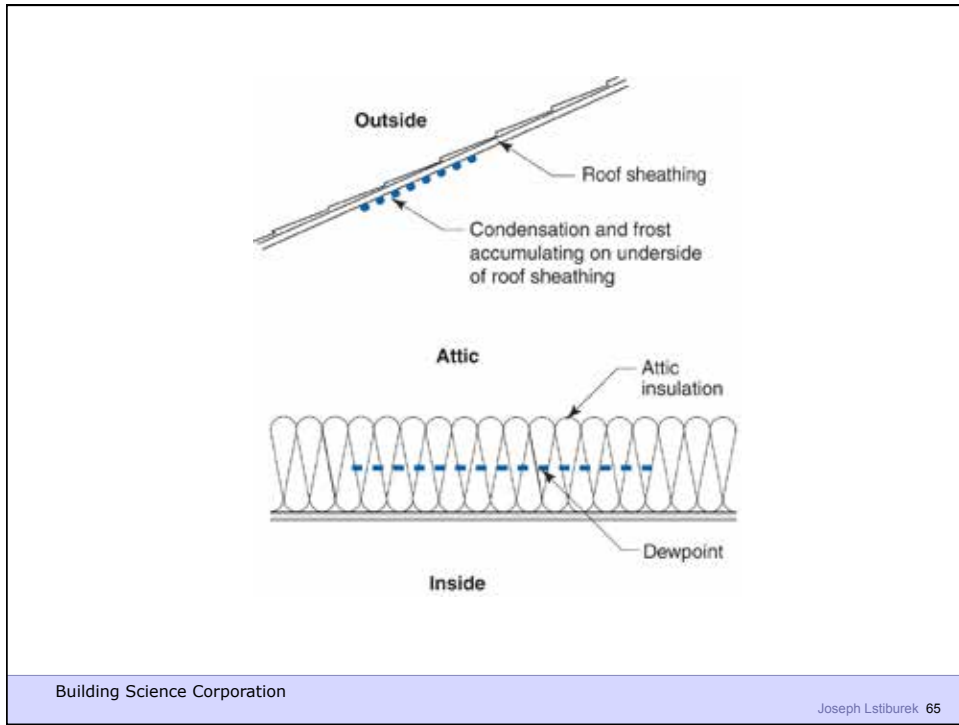

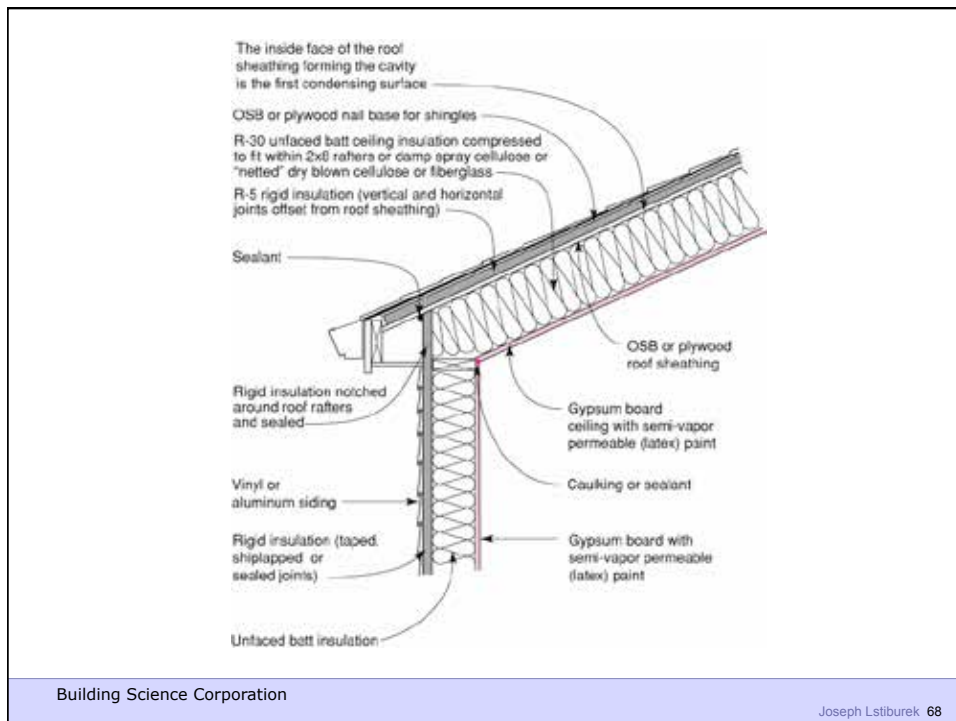
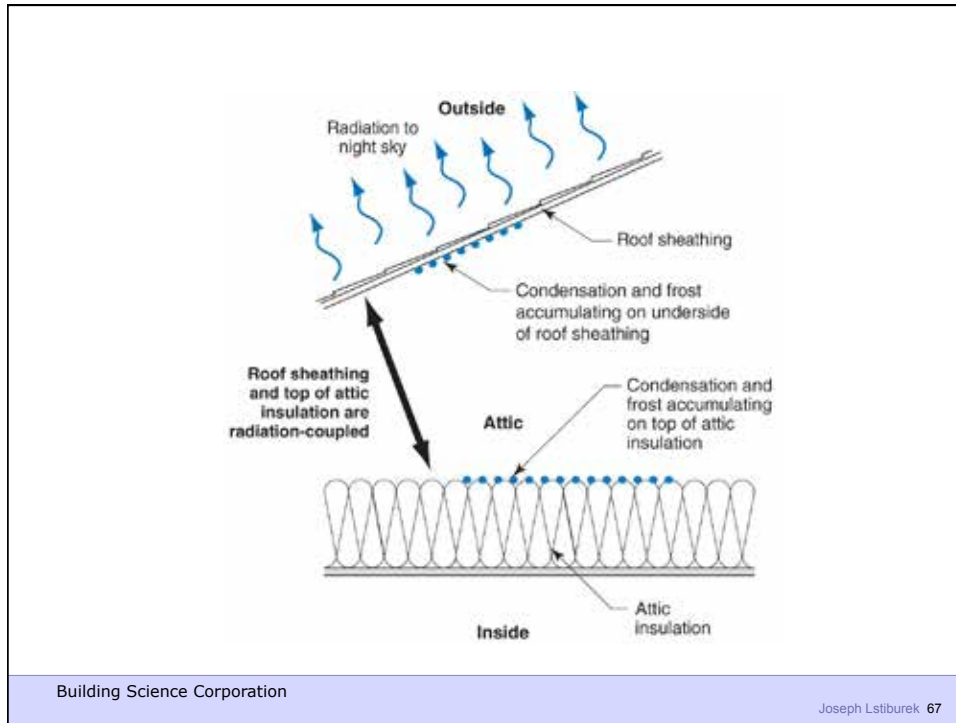

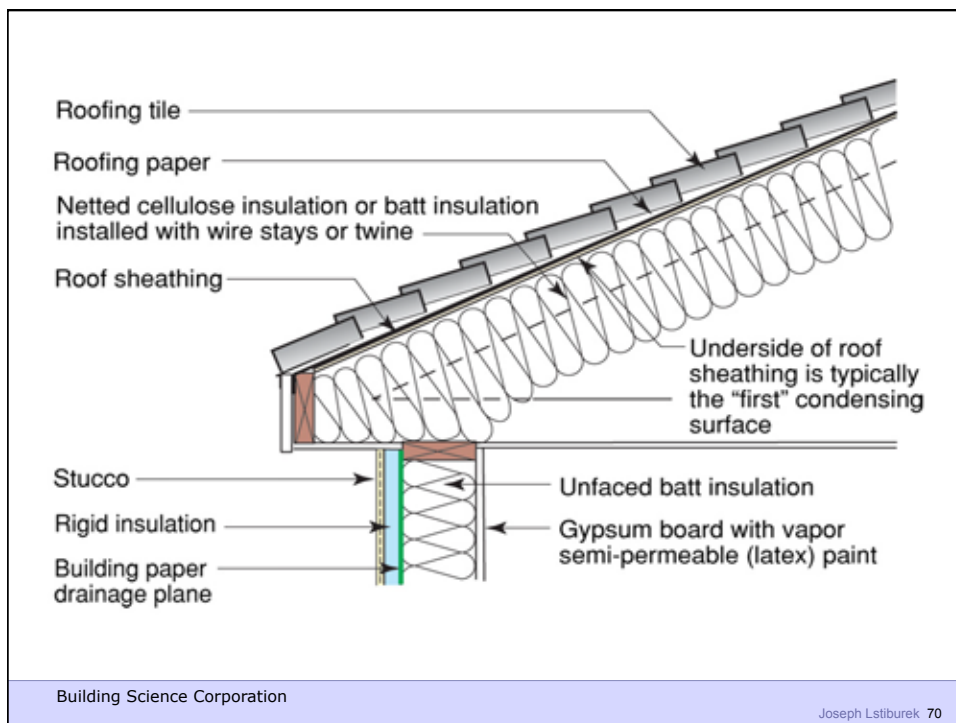
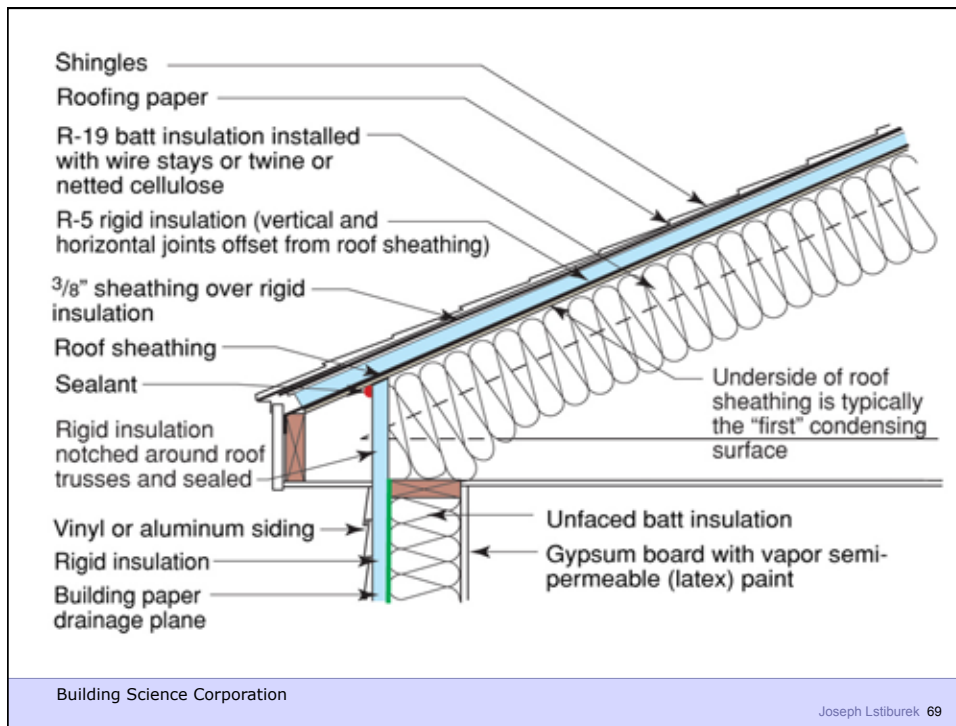

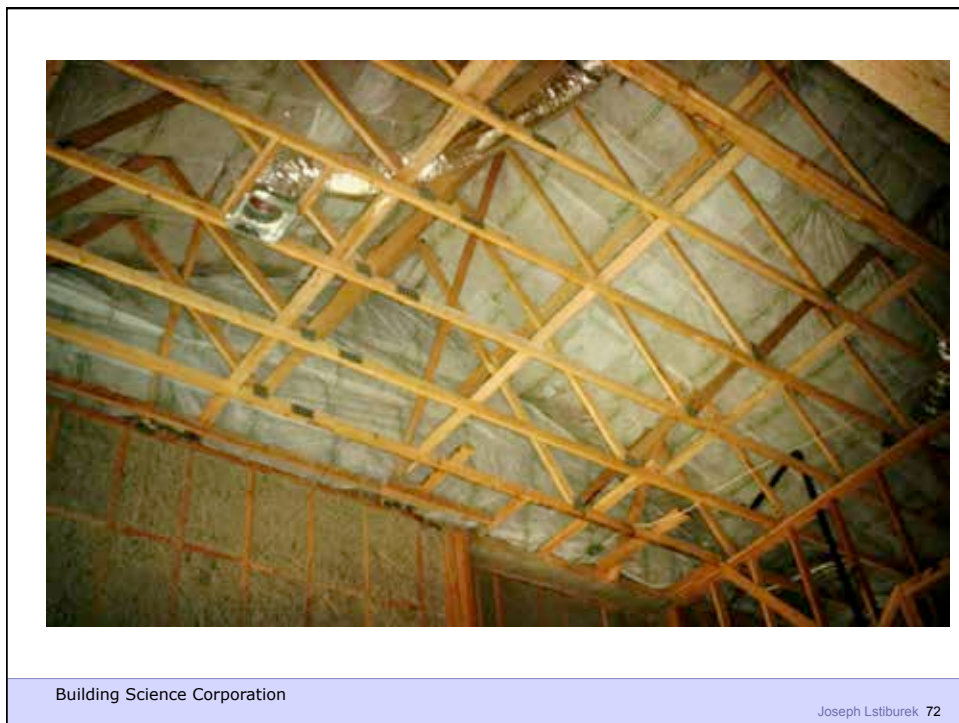

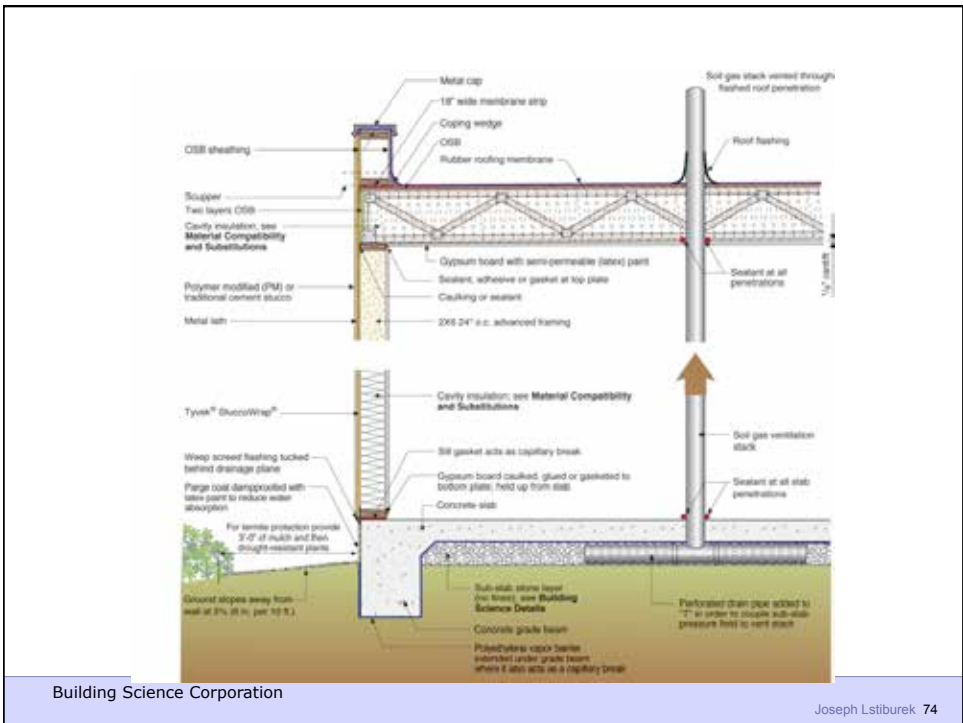

Truss Uplift

Building Science Corporation

Joseph Lstiburek 75





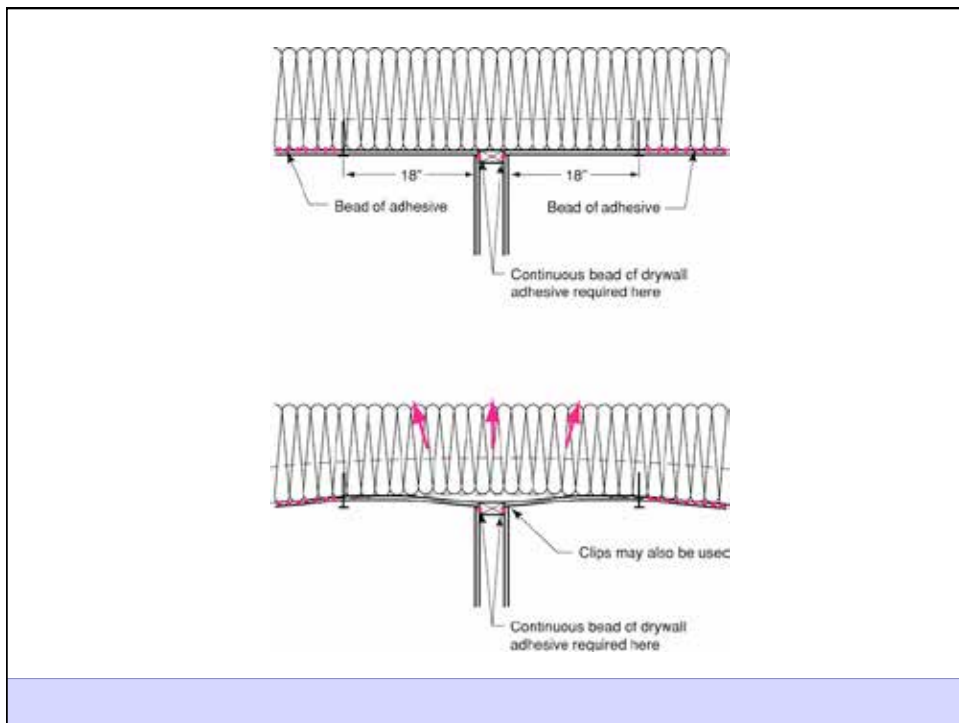
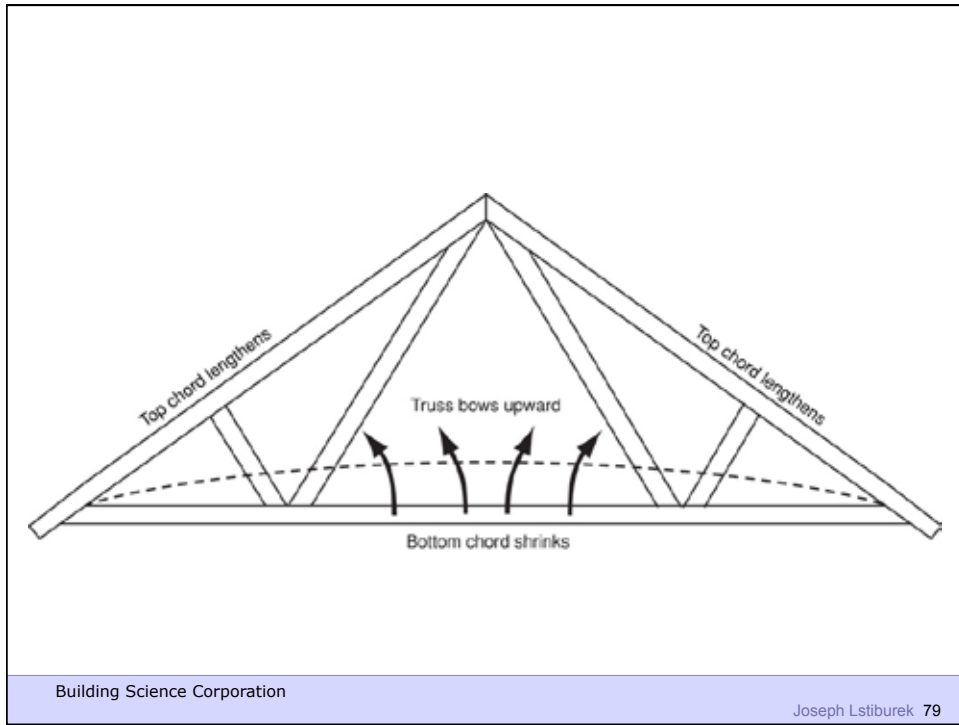

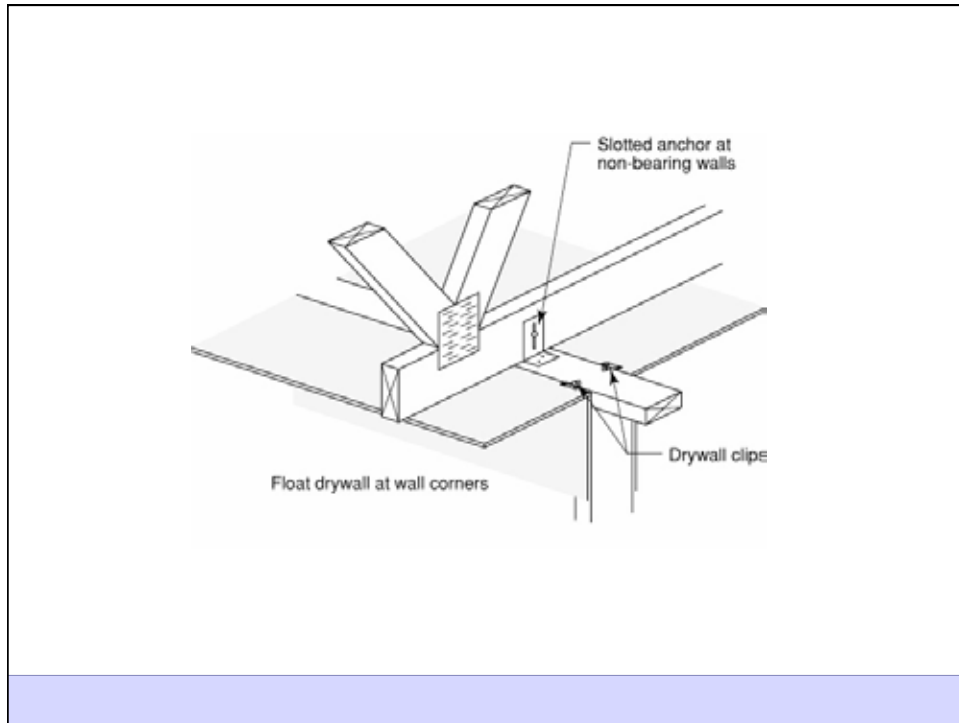

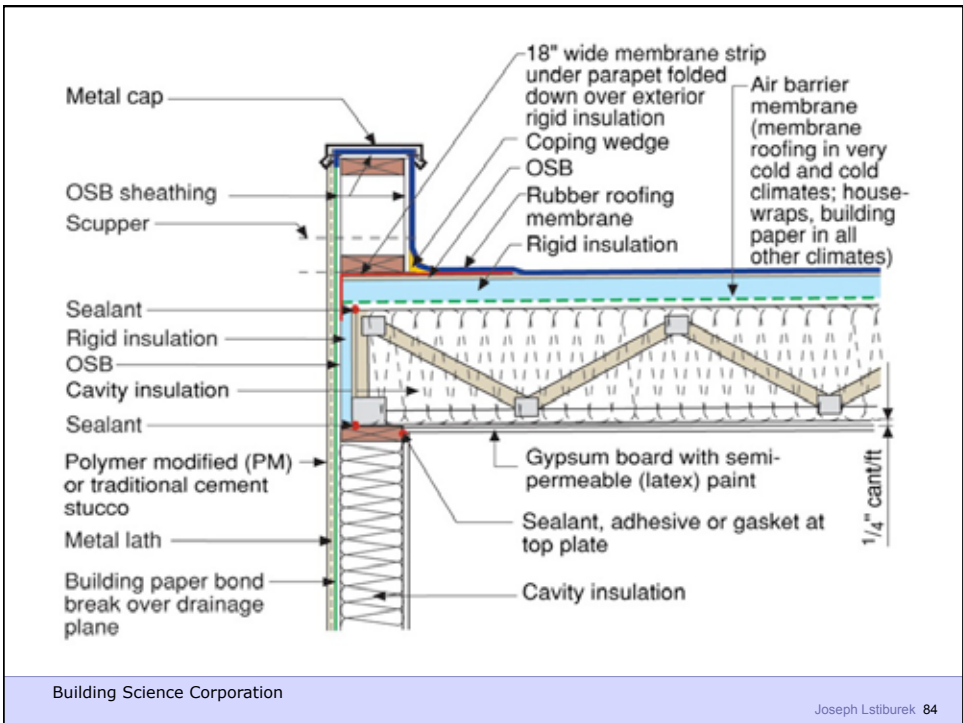

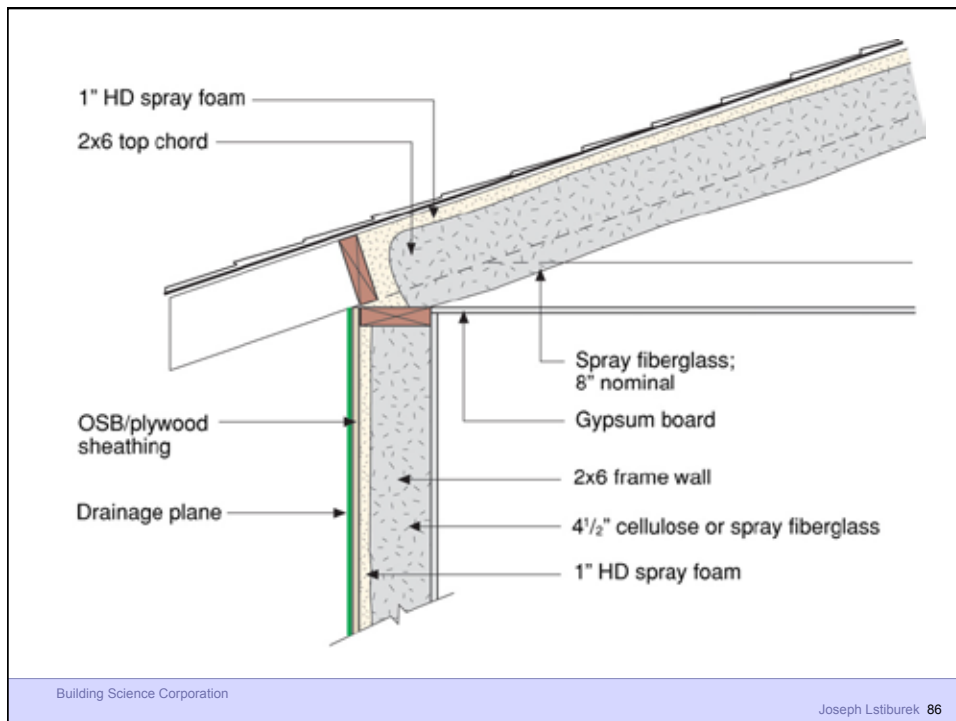
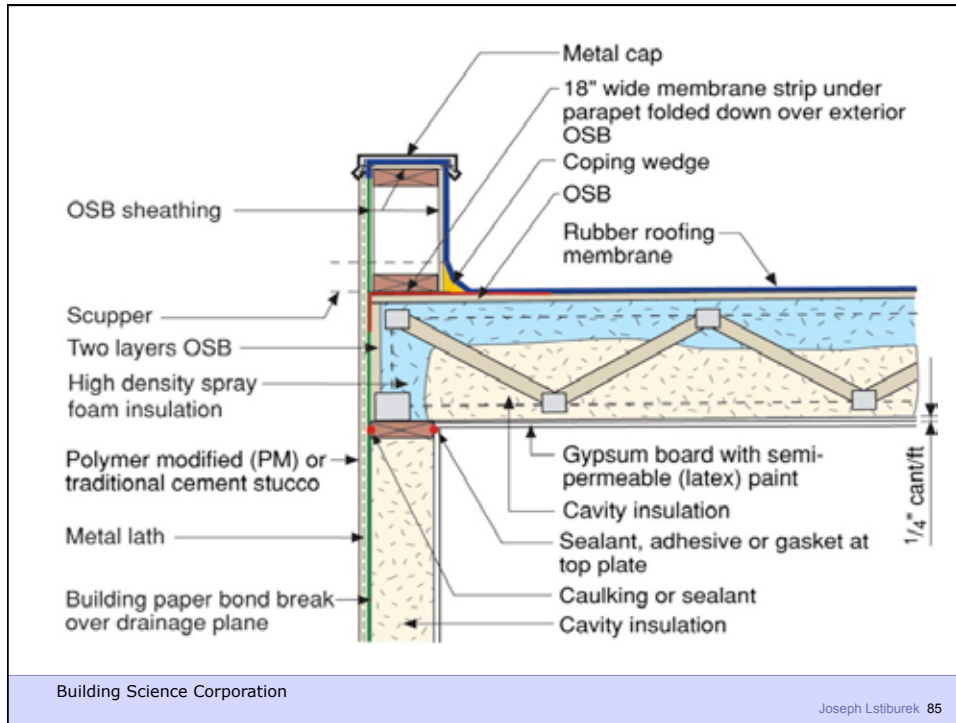

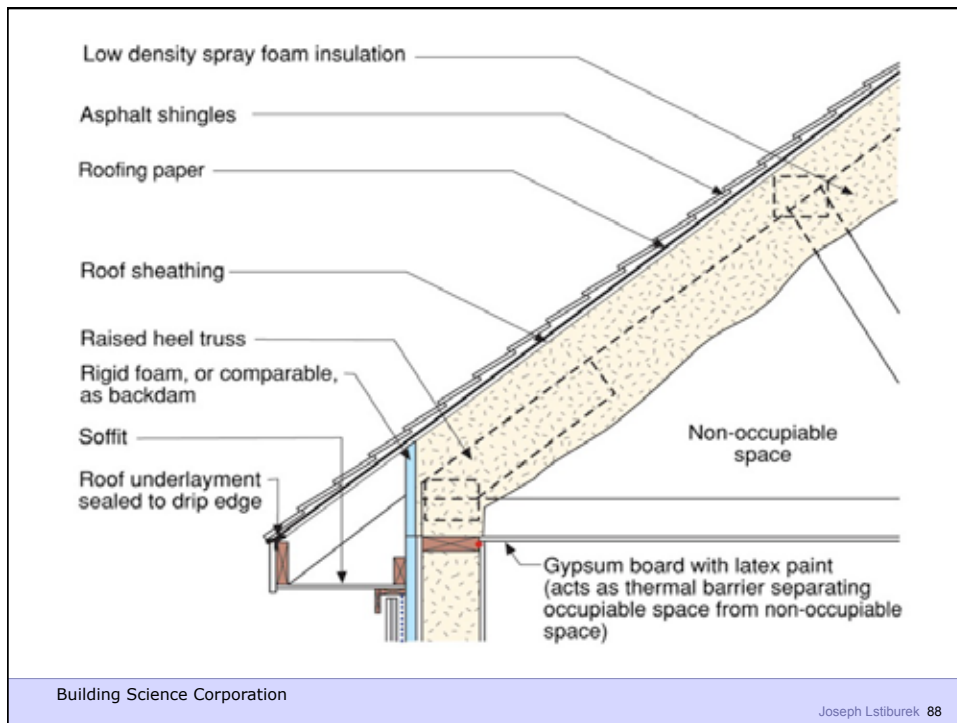
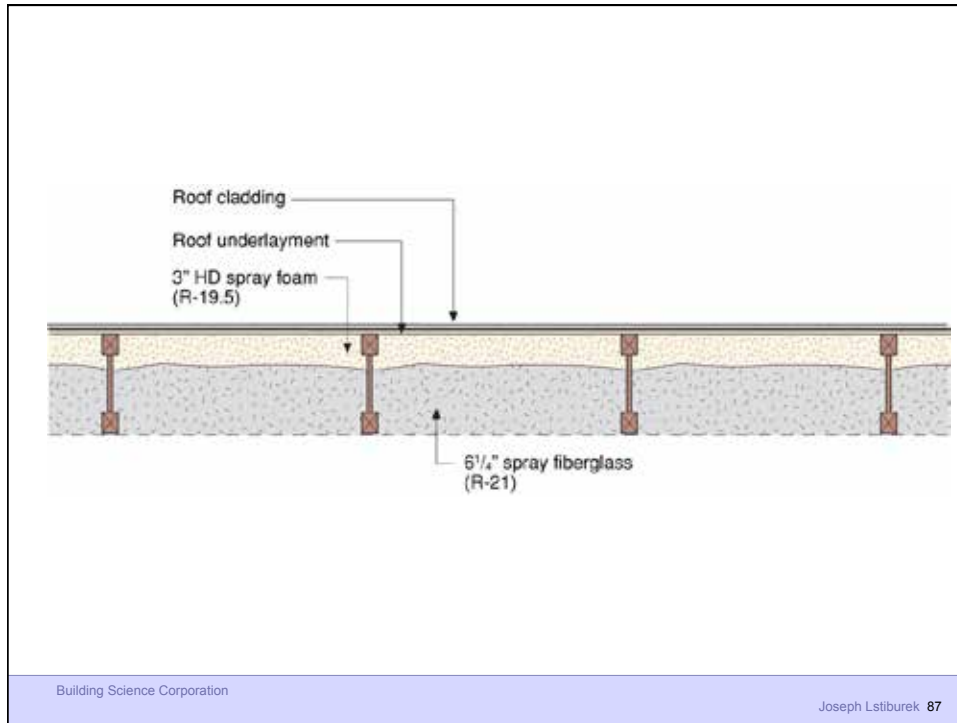



Building Science Corporation

Joseph Lstiburek 89



Building Science Corporation

Joseph Lstiburek 90



Building Science Corporation

Joseph Lstiburek 91



Building Science Corporation

Joseph Lstiburek 92



Building Science Corporation

Joseph Lstiburek 93

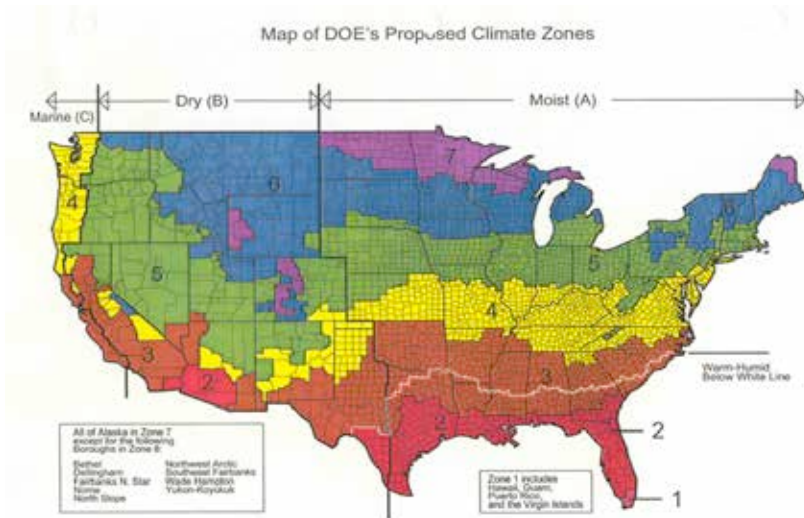

Building Science Corporation

Joseph Lstiburek 94





Building Science Corporation

Joseph Lstiburek 97

Conditioned Attics Not Unvented Attics

Building Science Corporation

Joseph Lstiburek 98

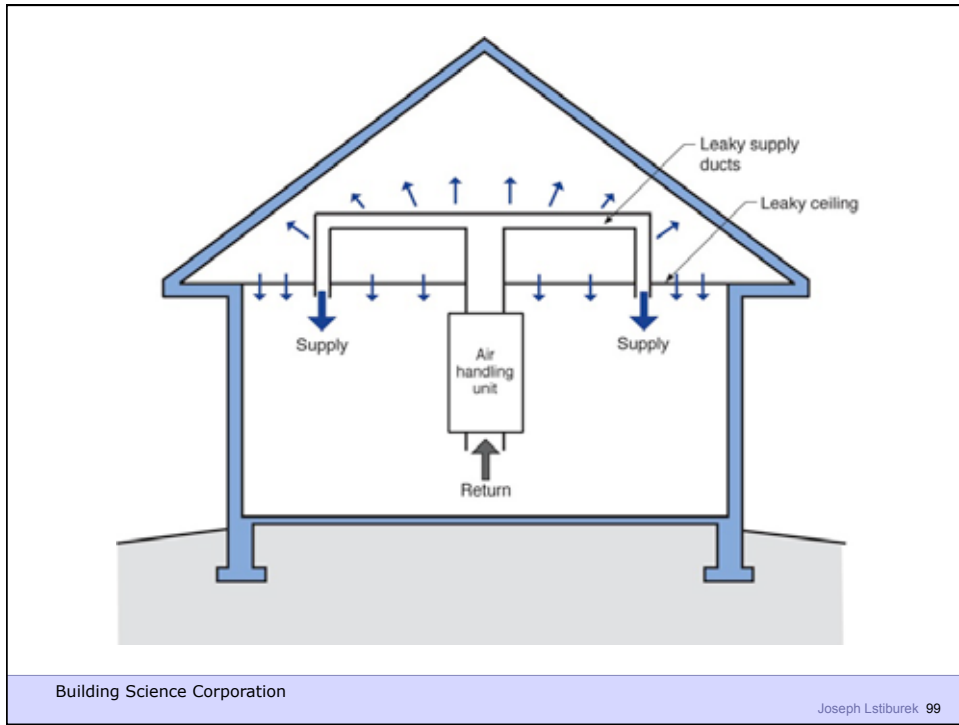

Conditioned Attics Not Unvented Attics
Need Supply Air

Conditioned Attics Not Unvented Attics
Need Supply Air
50 cfm/1000 ft² of Attic

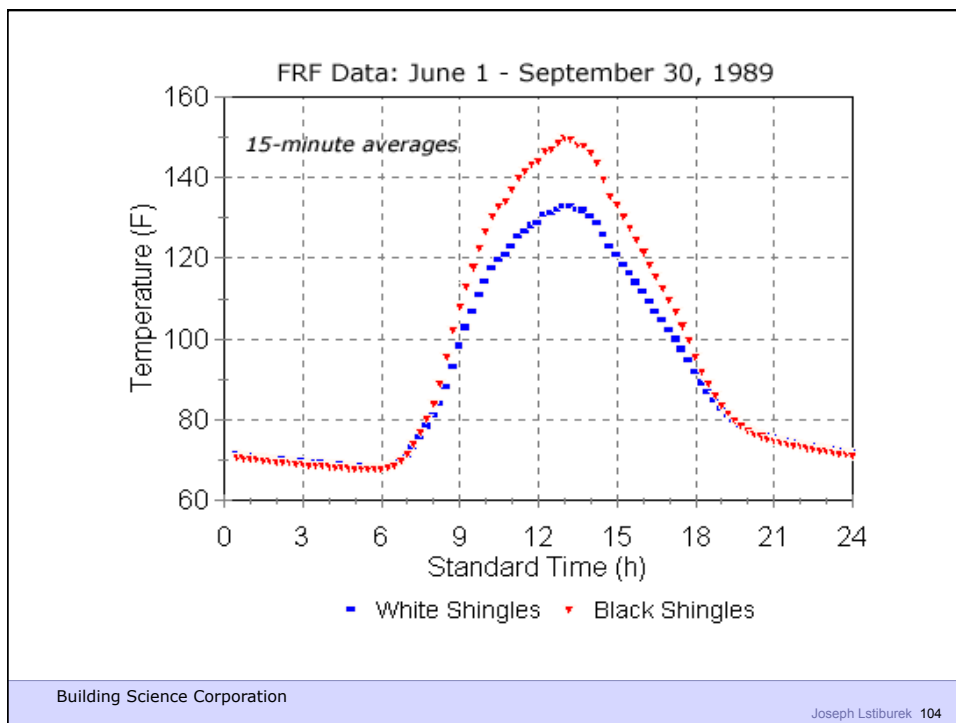
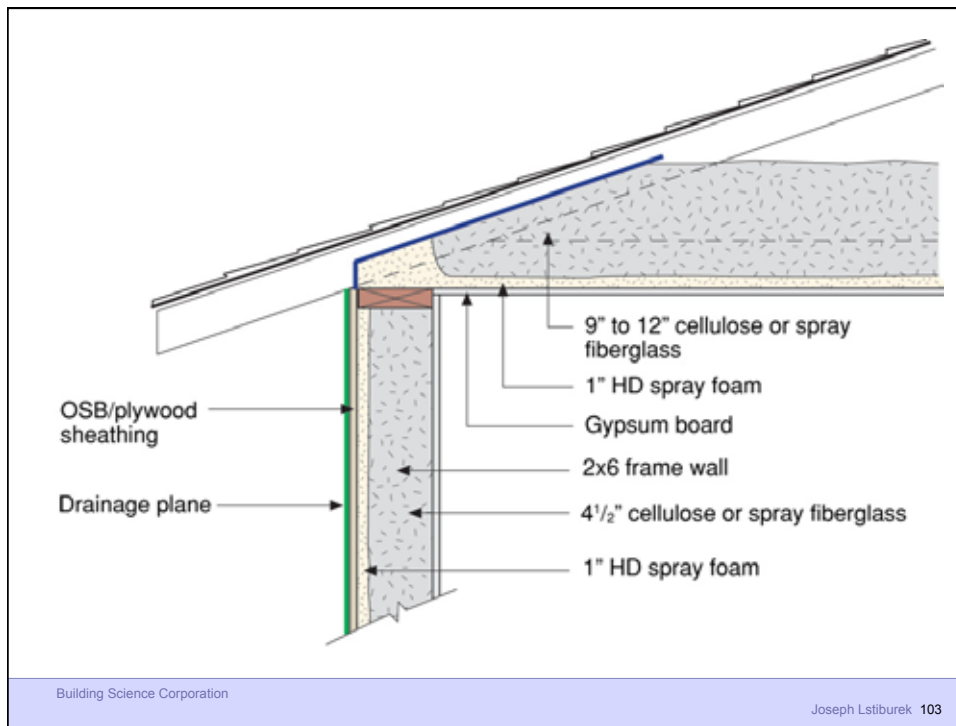

Vented vs. unvented shingle temperatures

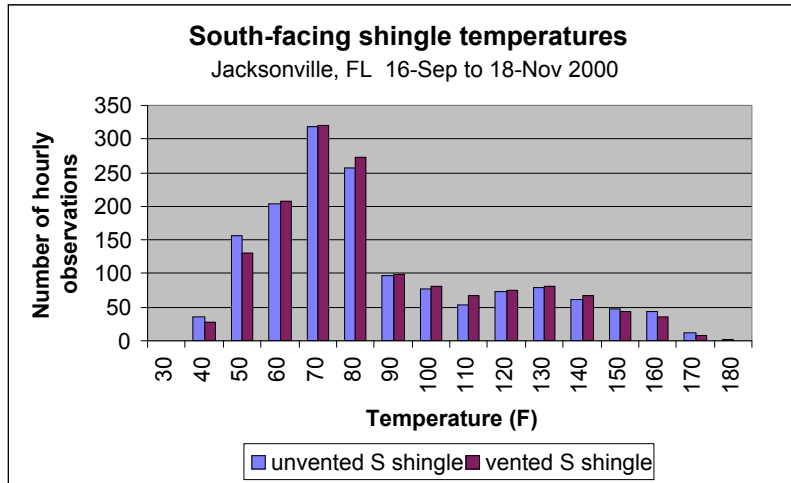

Building Science Corporation

Joseph Lstiburek 105

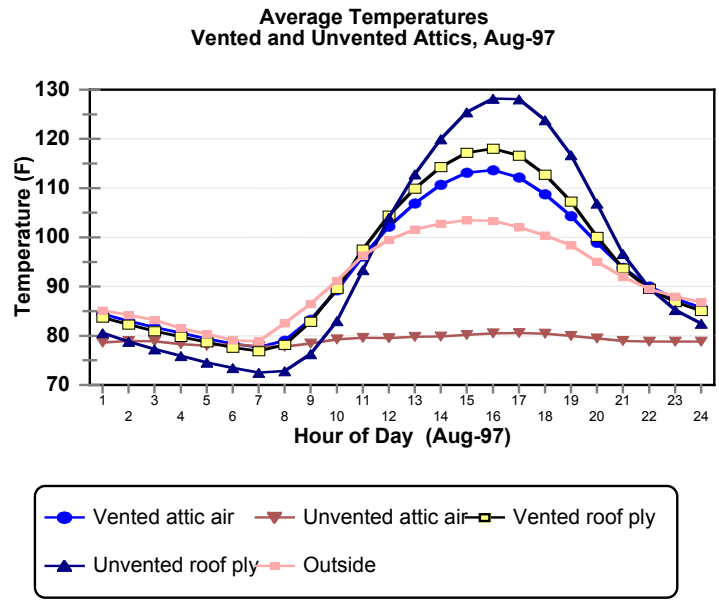

Building Science Corporation

Joseph Lstiburek 106

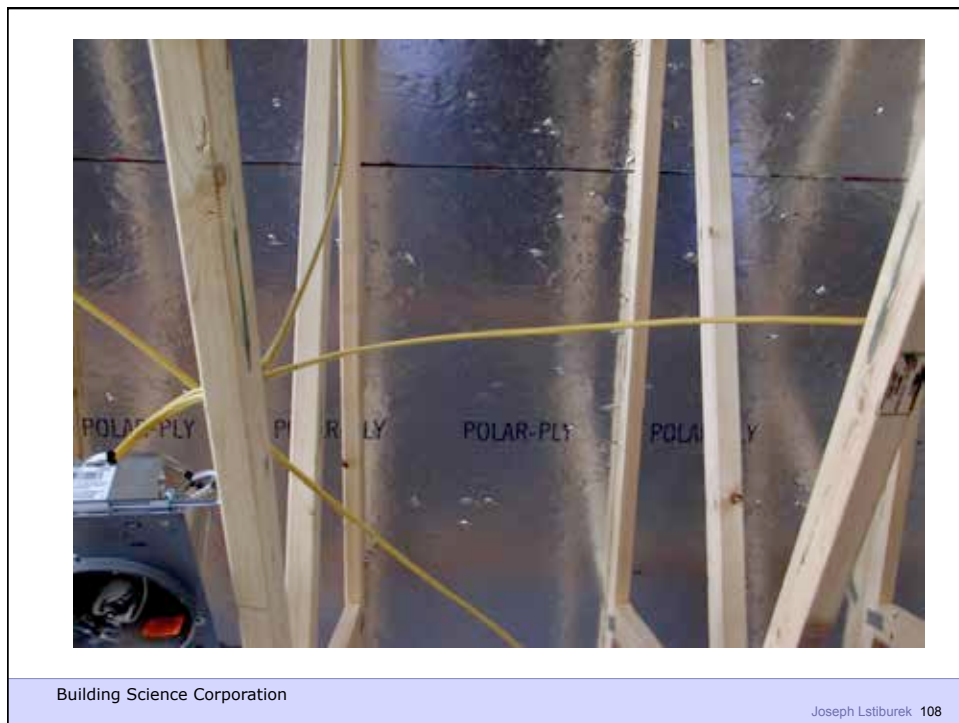
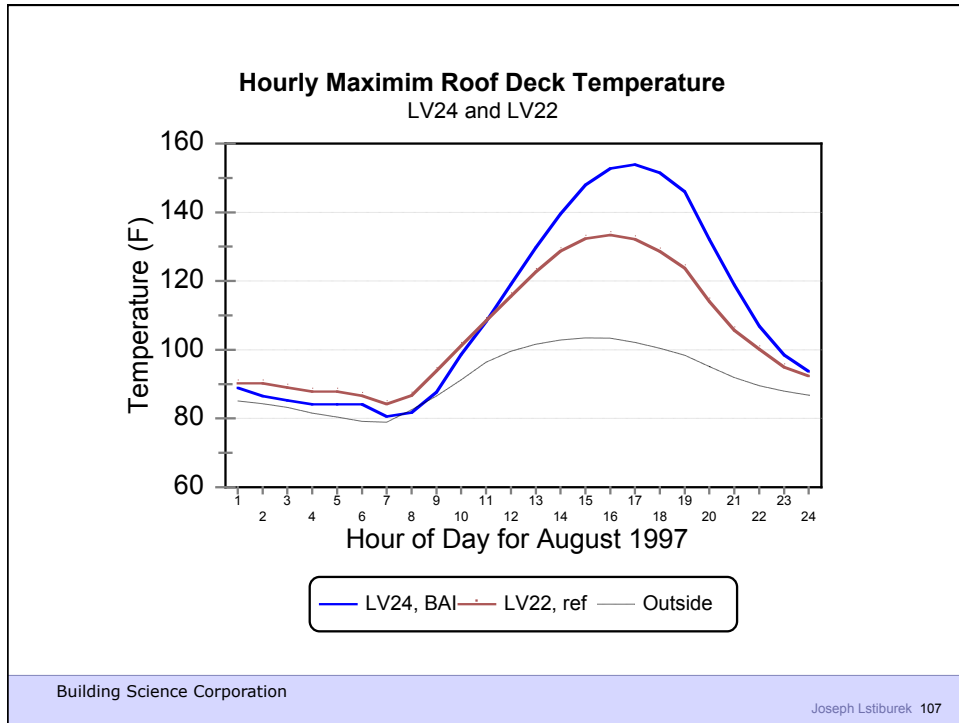

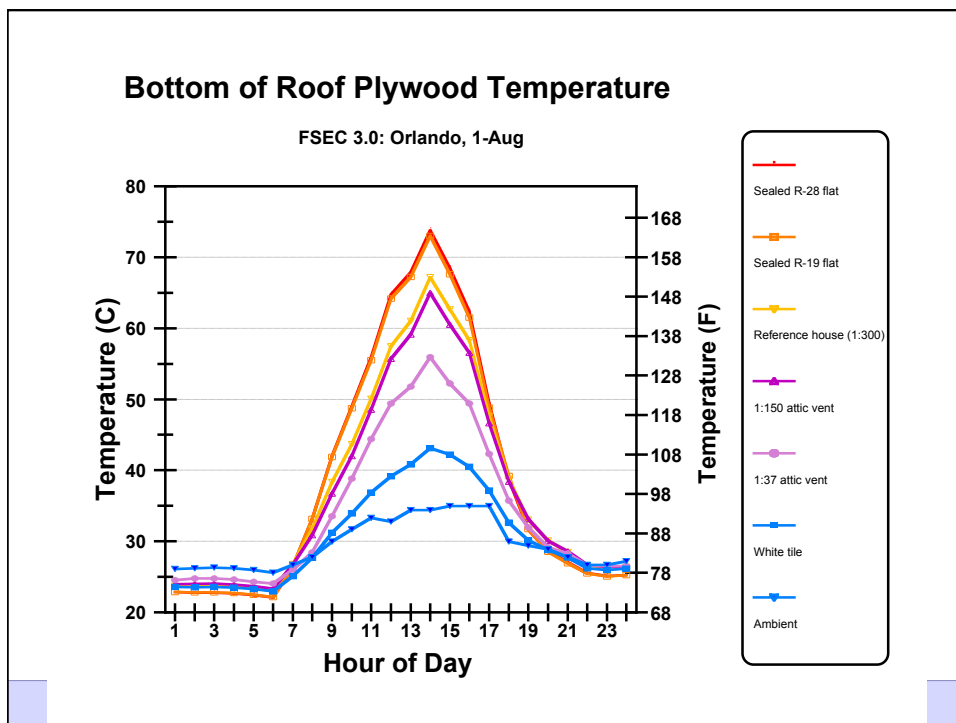
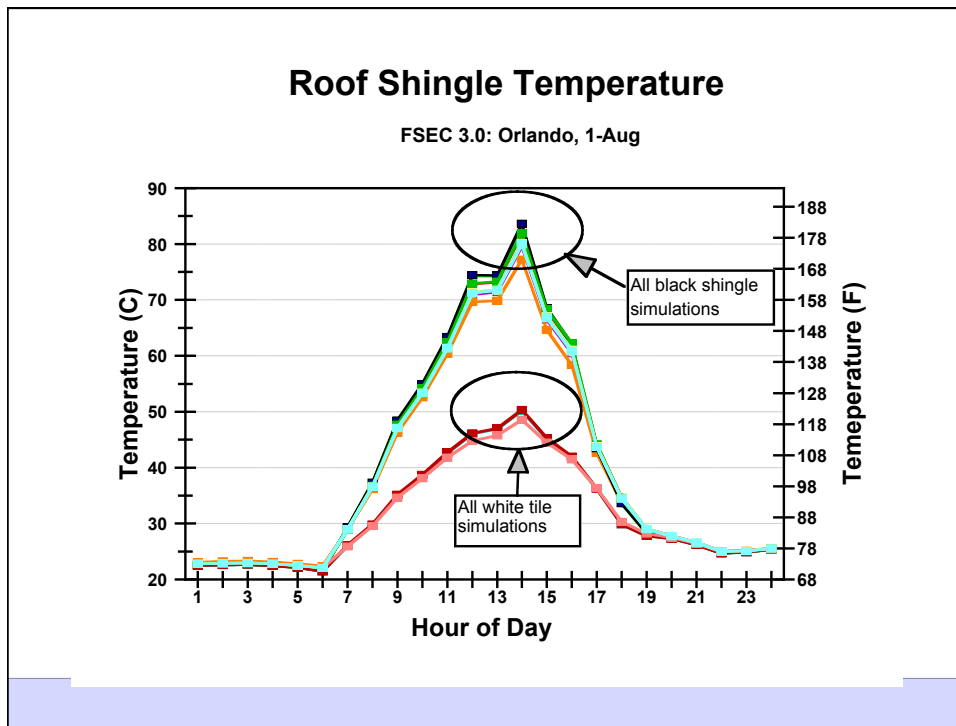

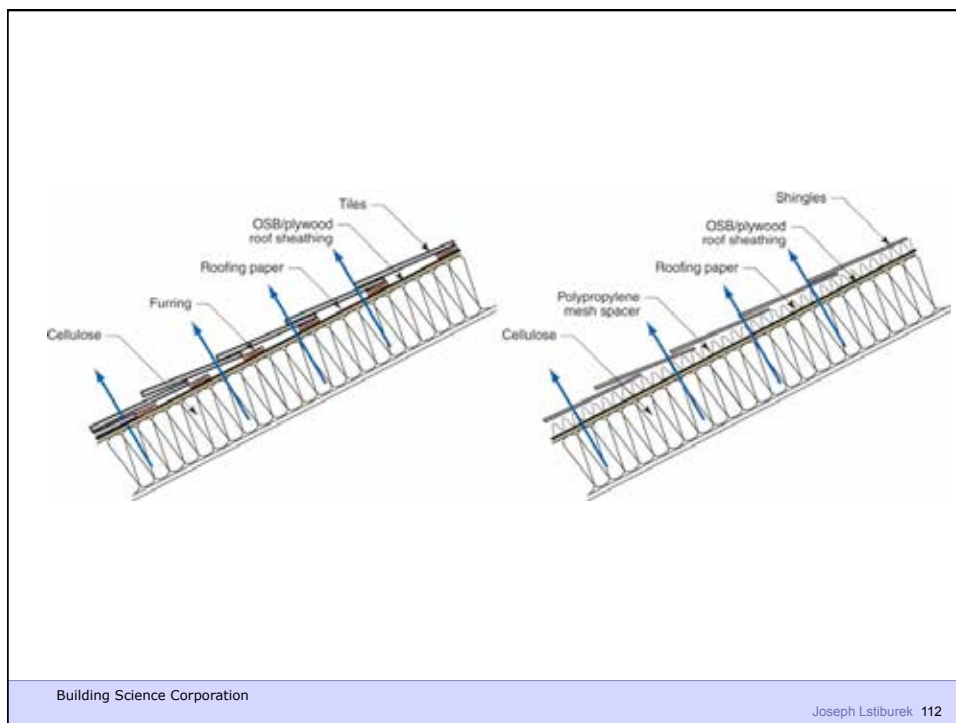
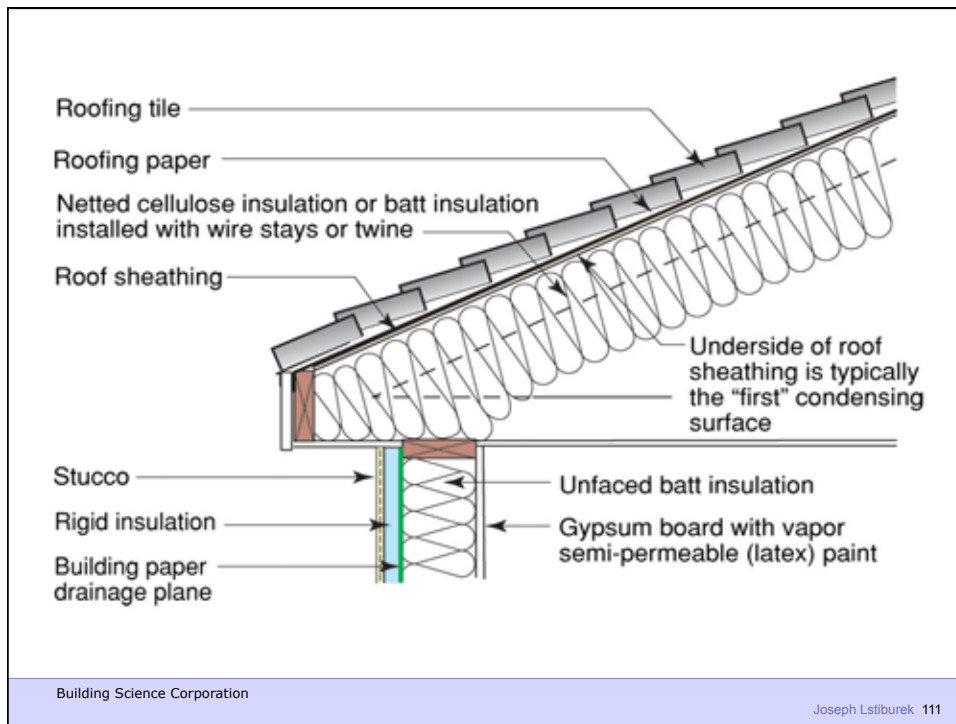



Building Science Corporation

Joseph Lstiburek 113



Building Science Corporation

Joseph Lstiburek 114

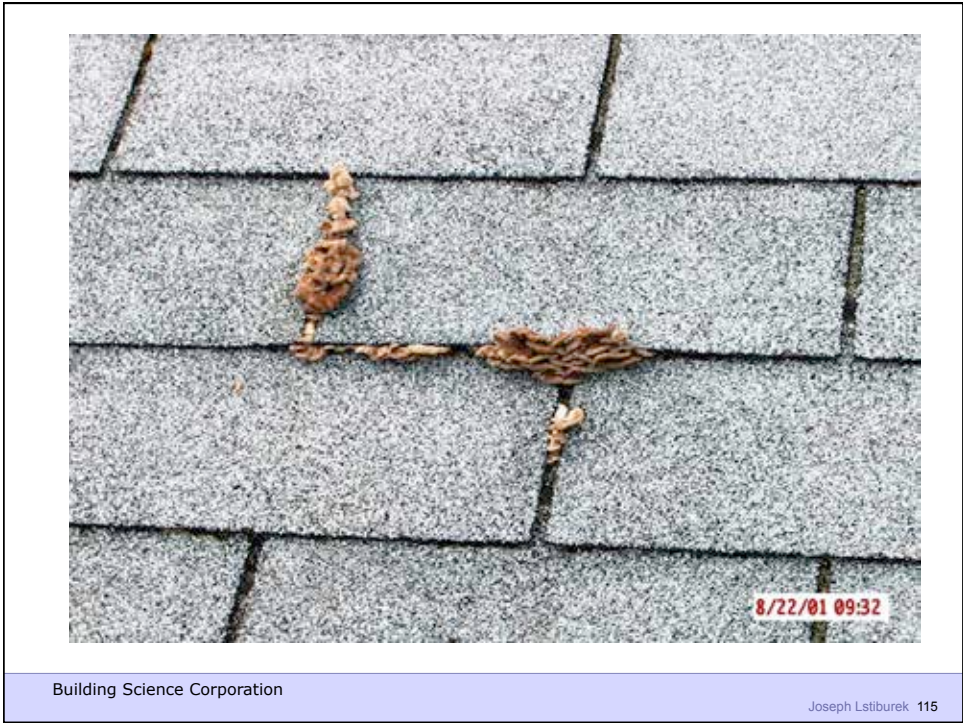



Building Science Corporation

Joseph Lstiburek 117

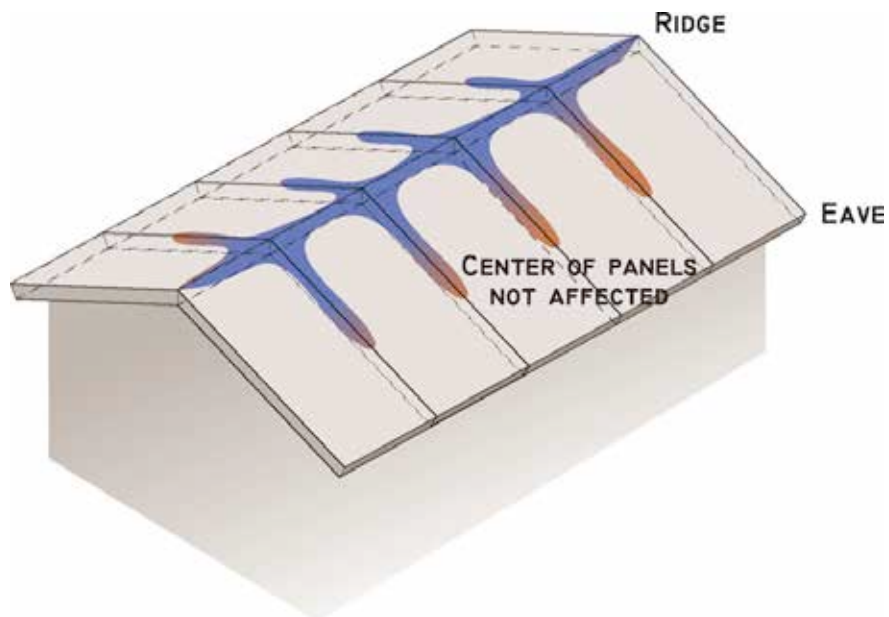

Building Science Corporation

Joseph Lstiburek 118



Building Science Corporation

Joseph Lstiburek 119



Building Science Corporation

Joseph Lstiburek 120



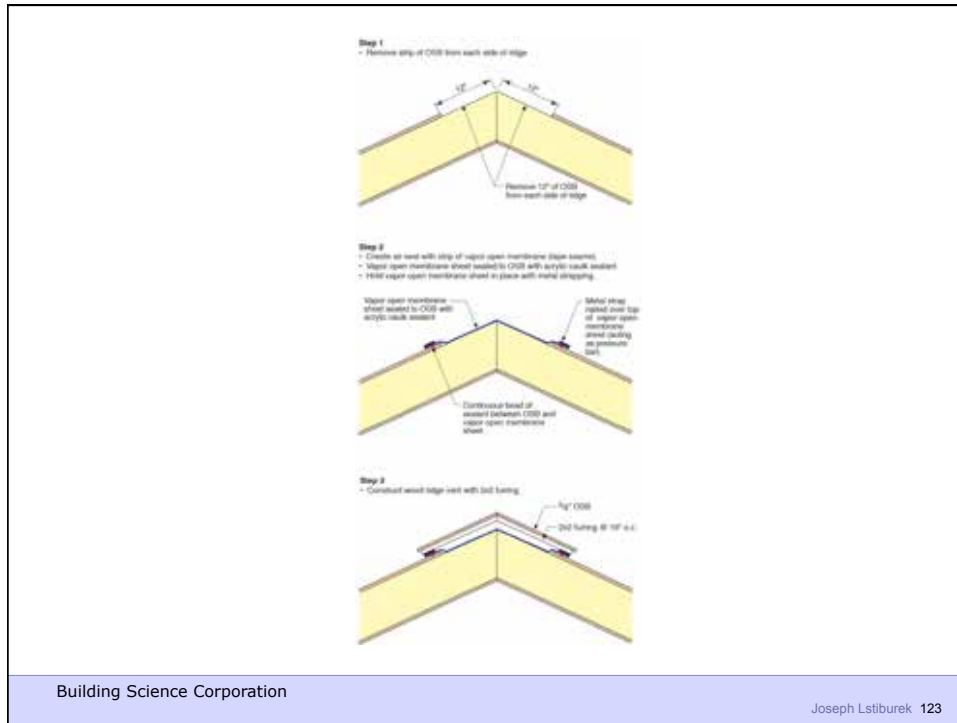

Building Science Corporation

Joseph Lstiburek 123



Building Science Corporation

Joseph Lstiburek 124



Building Science Corporation

Joseph Lstiburek 125



Building Science Corporation

Joseph Lstiburek 126



Building Science Corporation

Joseph Lstiburek 127



Building Science Corporation

Joseph Lstiburek 128



Building Science Corporation

Joseph Lstiburek 129



Building Science Corporation

Joseph Lstiburek 130



Building Science Corporation

Joseph Lstiburek 131

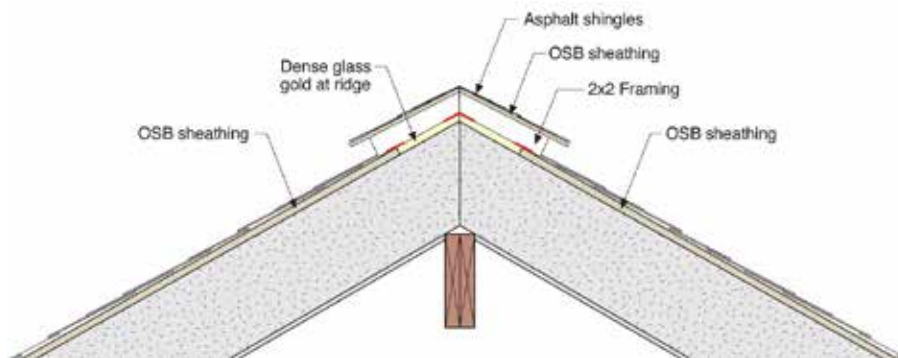

Building Science Corporation

Joseph Lstiburek 132

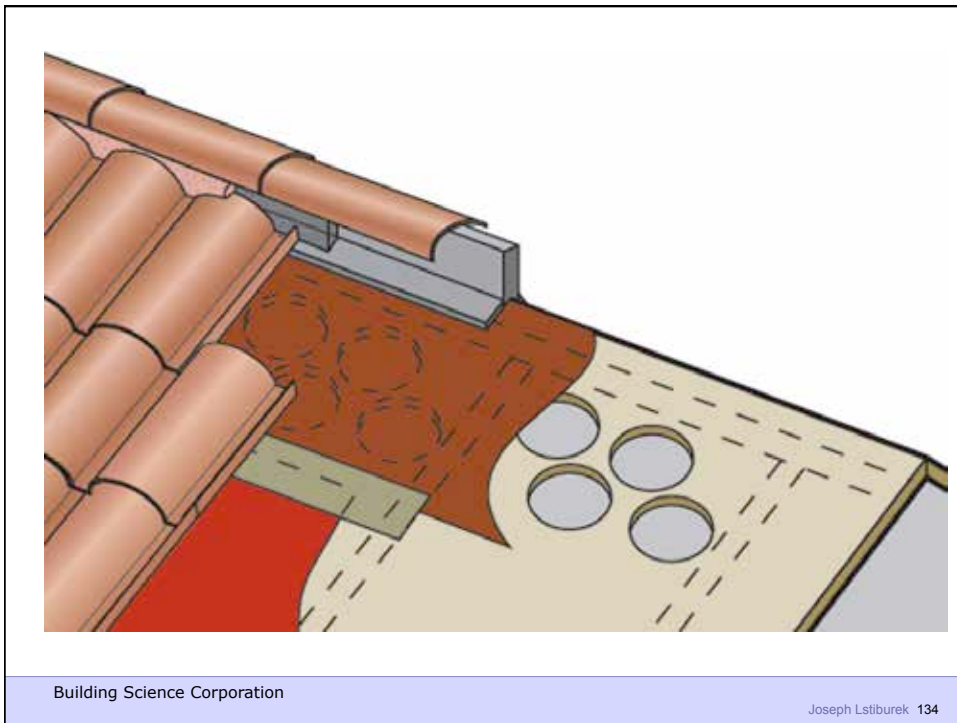
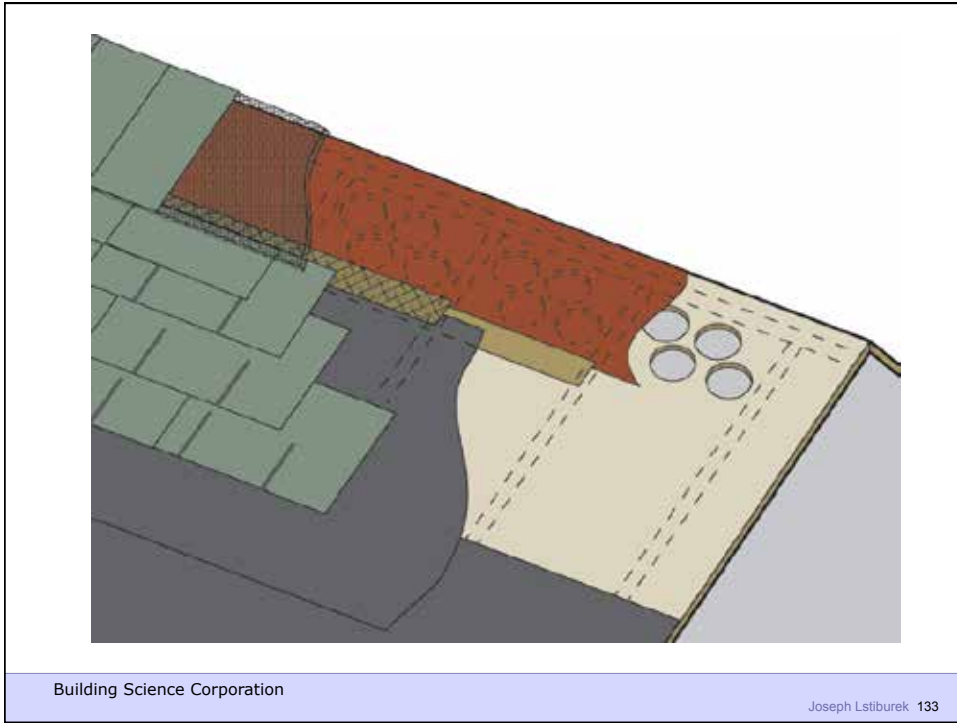

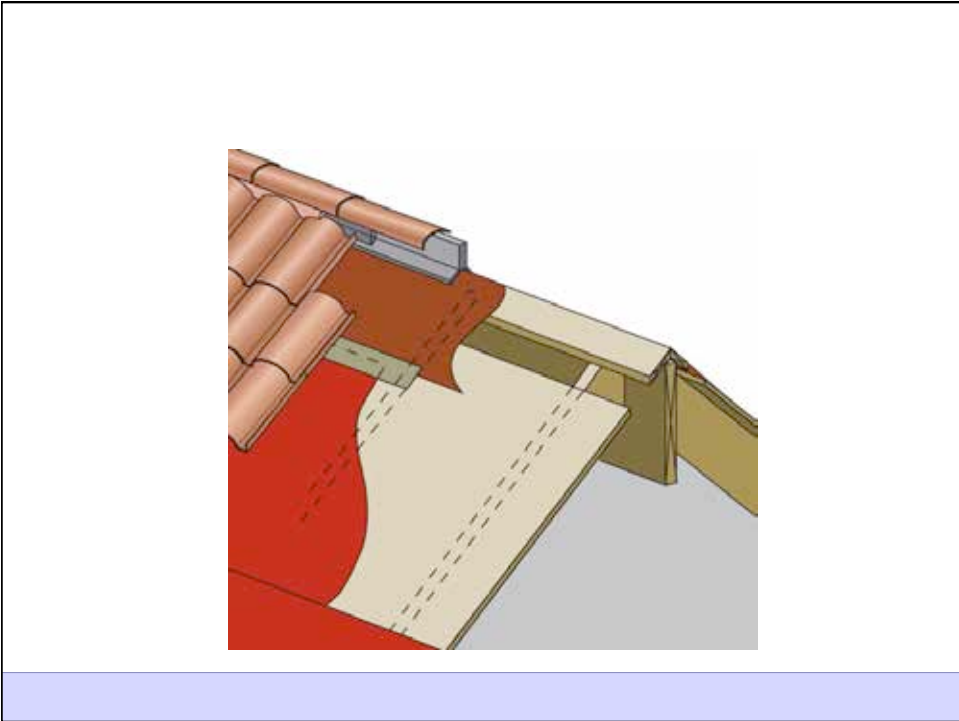
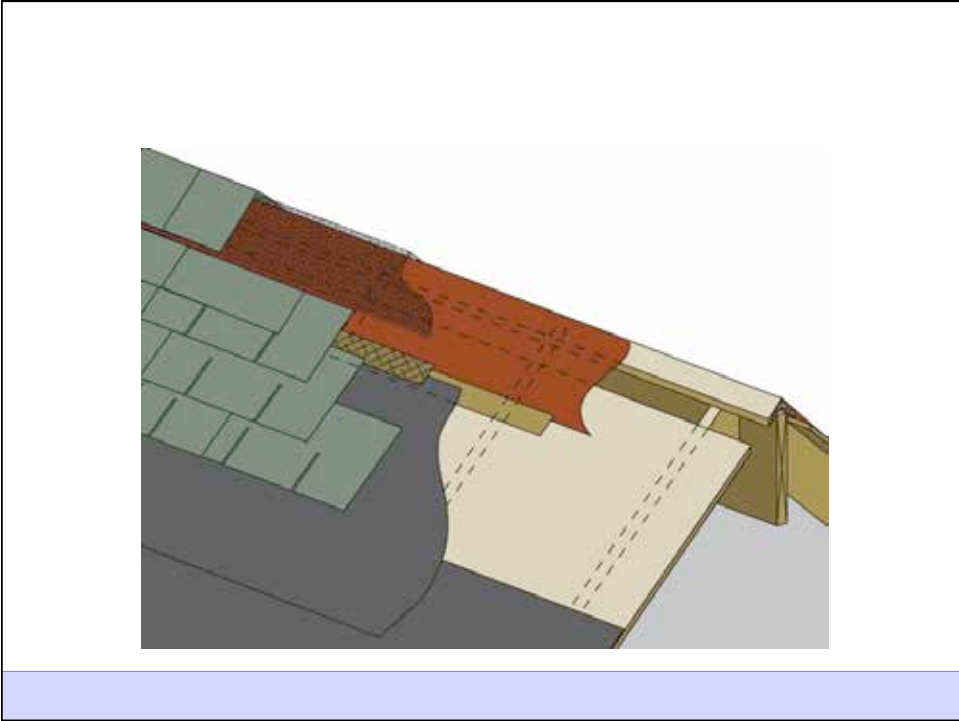



Building Science Corporation

Joseph Lstiburek 137



Building Science Corporation

Joseph Lstiburek 138



Building Science Corporation

Joseph Lstiburek 139



Building Science Corporation

Joseph Lstiburek 140

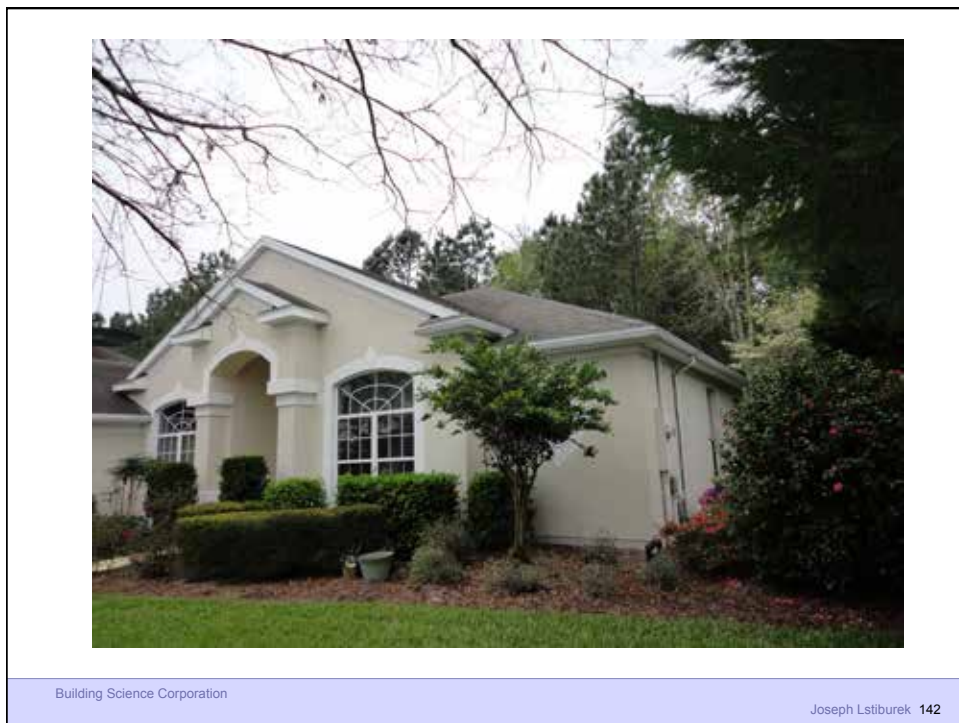



Building Science Corporation

Joseph Lstiburek 143



Building Science Corporation

Joseph Lstiburek 144

Burying Ducts

Building Science Corporation

Joseph Lstiburek 145

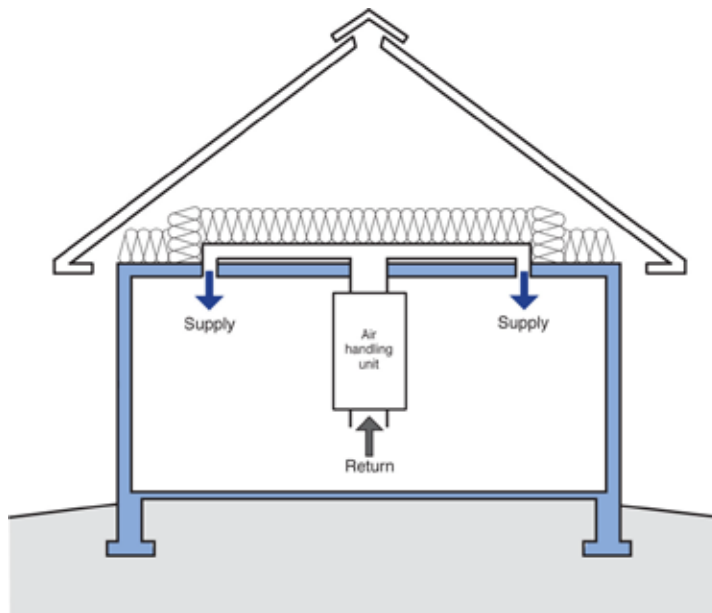

Building Science Corporation

Joseph Lstiburek 146

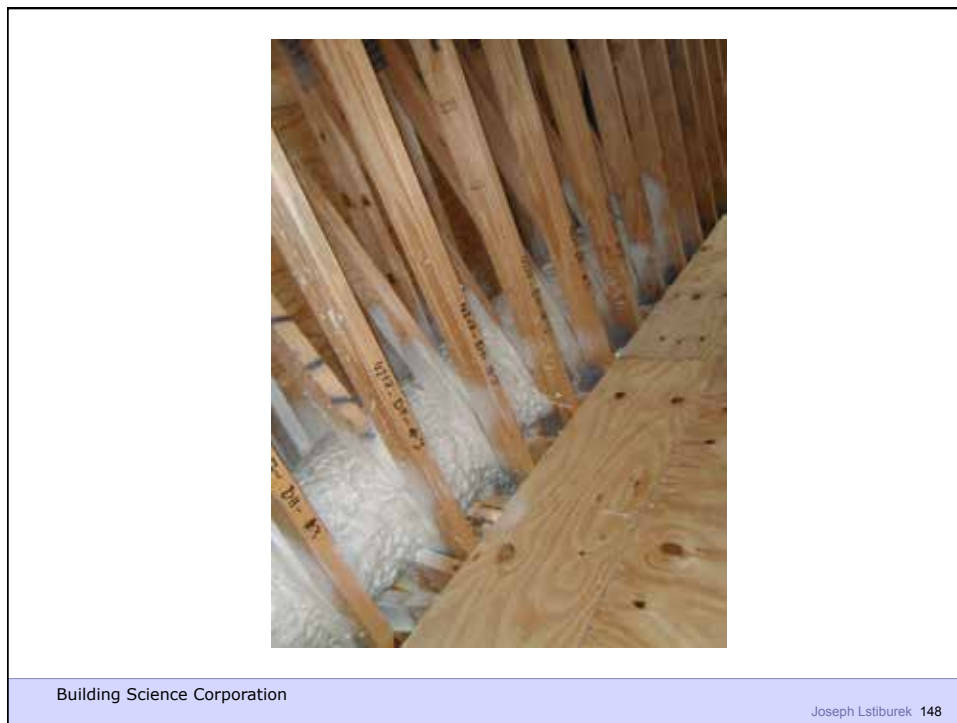
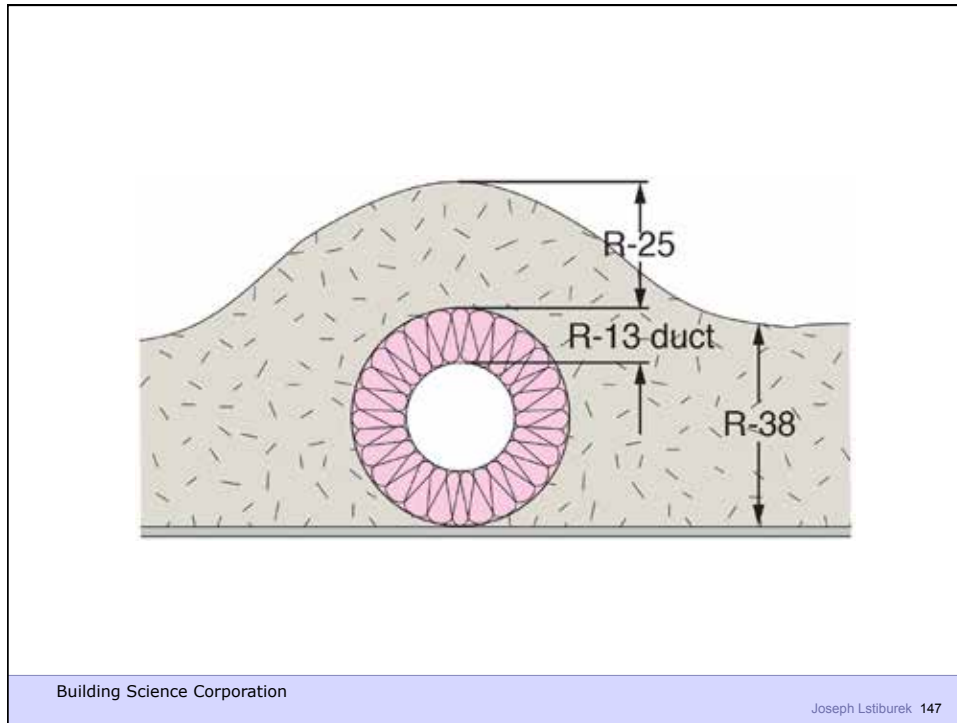



Building Science Corporation

Joseph Lstiburek 149



Building Science Corporation

Joseph Lstiburek 150

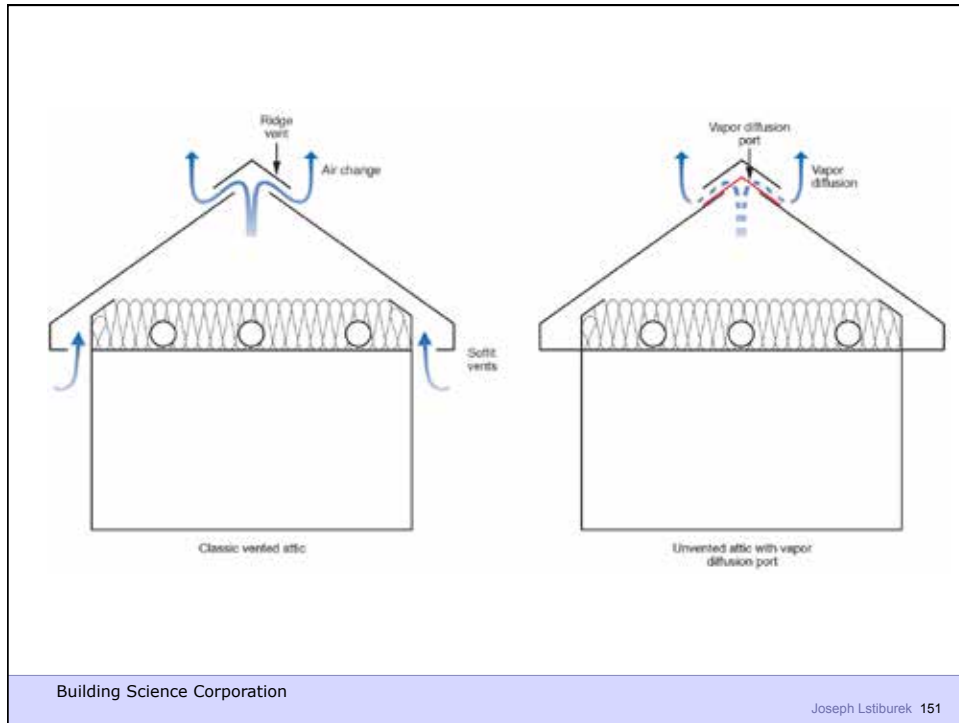

Where It Started

Building Science Corporation

Joseph Lstiburek 152



Building Science Corporation

Joseph Lstiburek 153



Building Science Corporation

Joseph Lstiburek 154

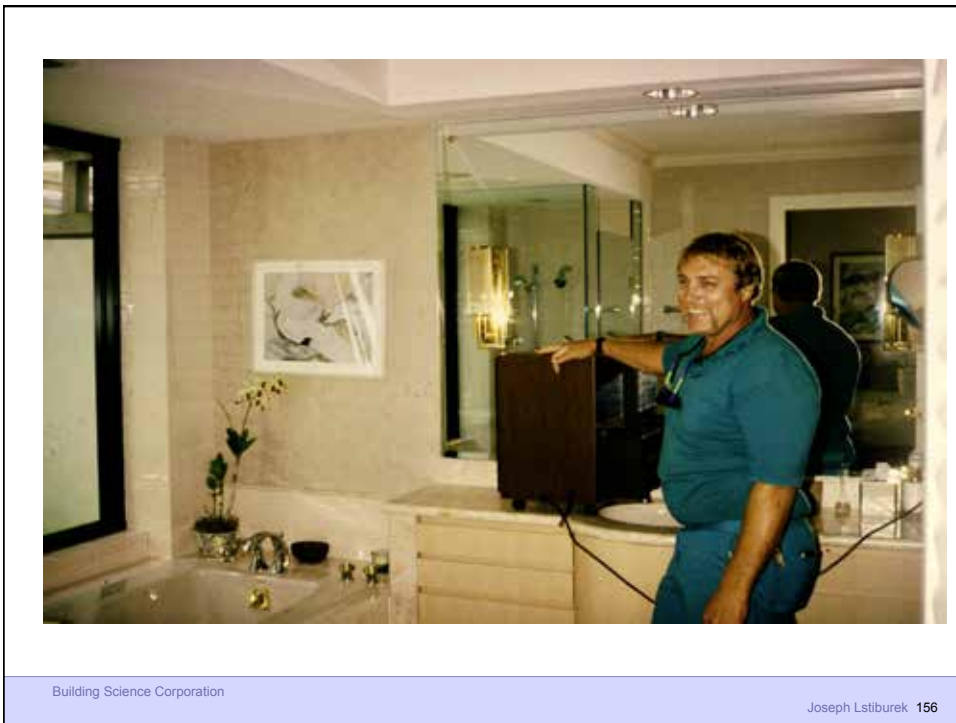



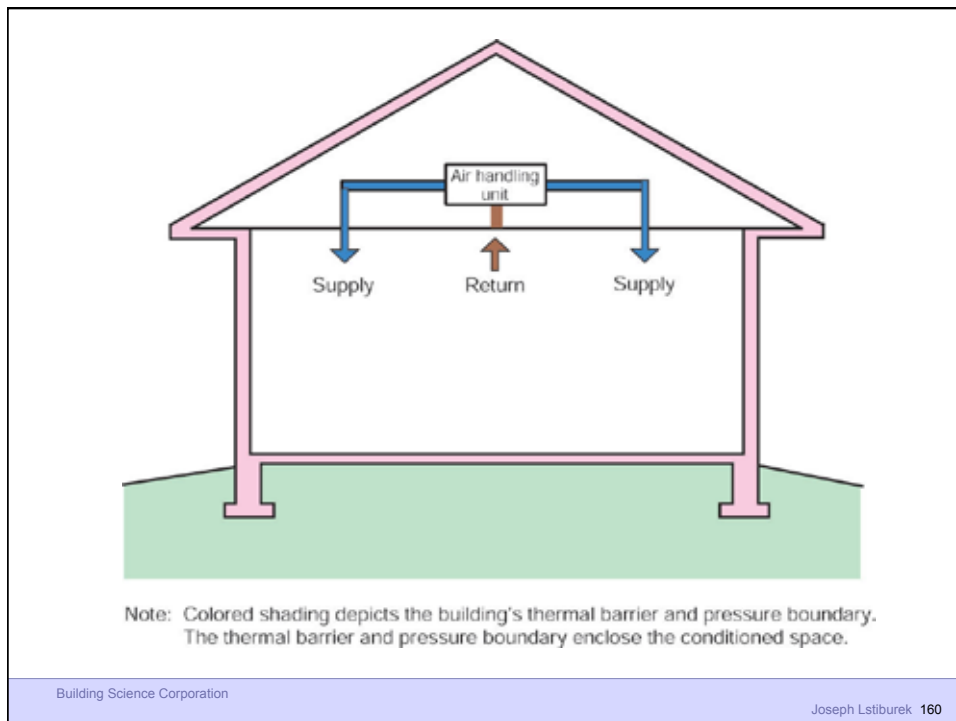
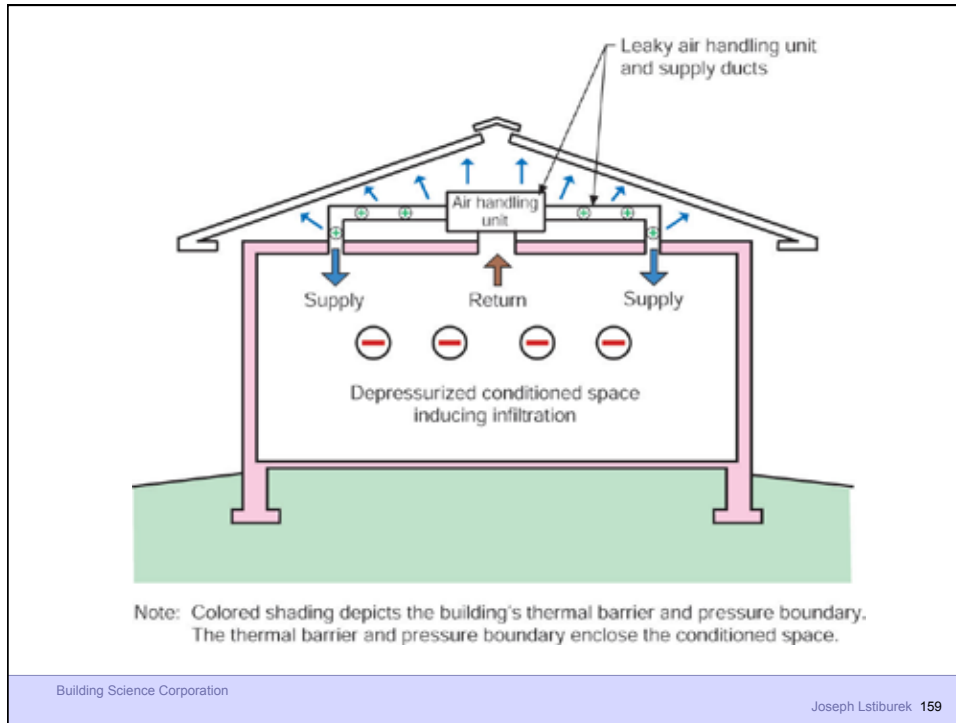

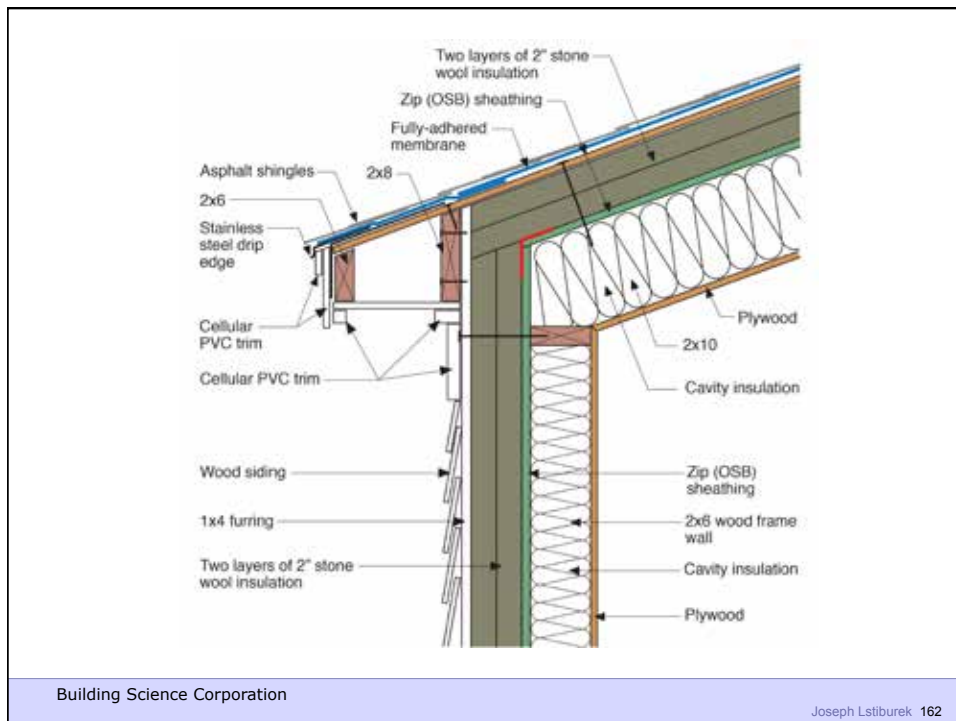
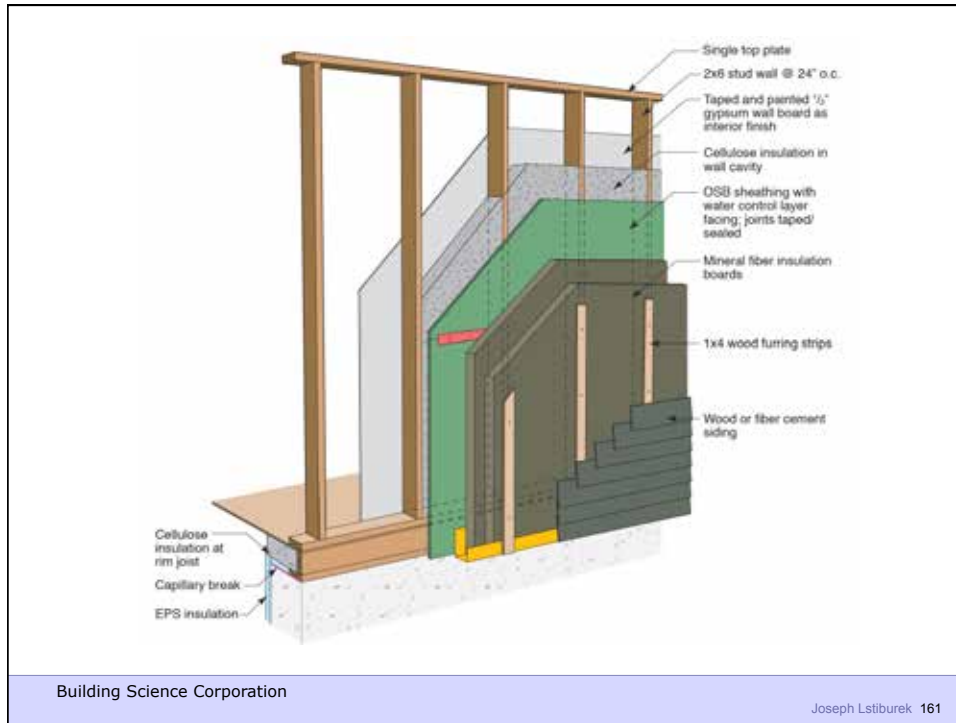

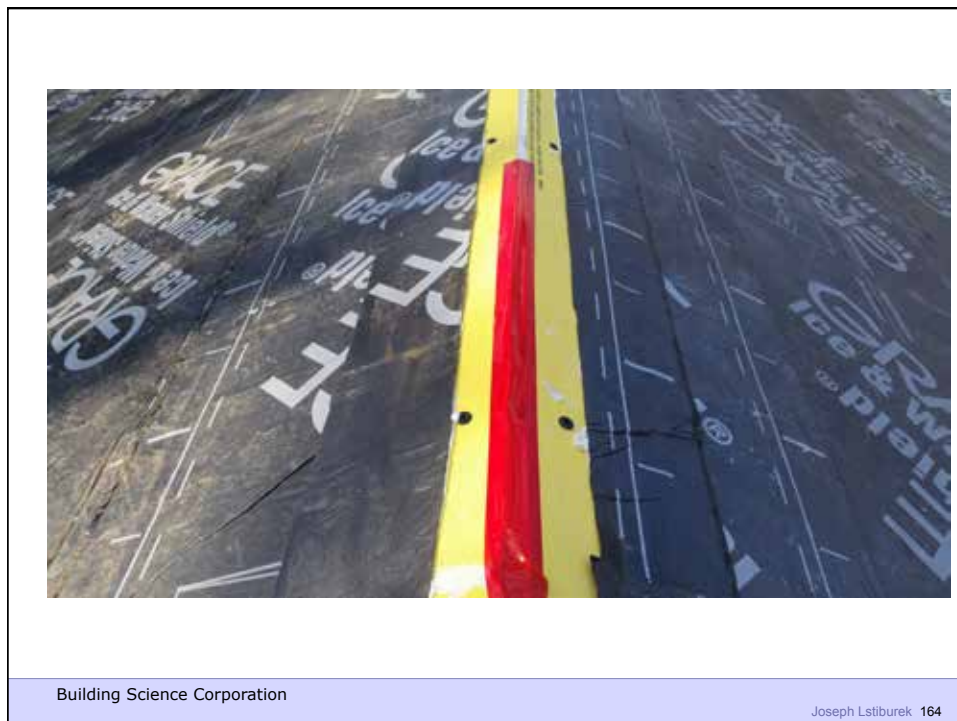
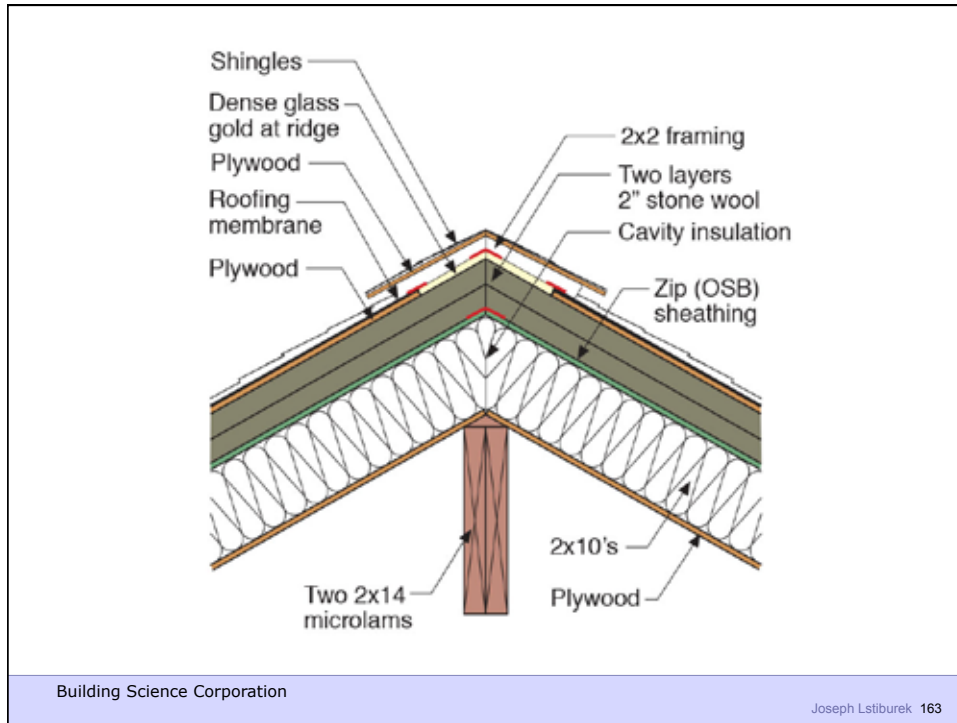

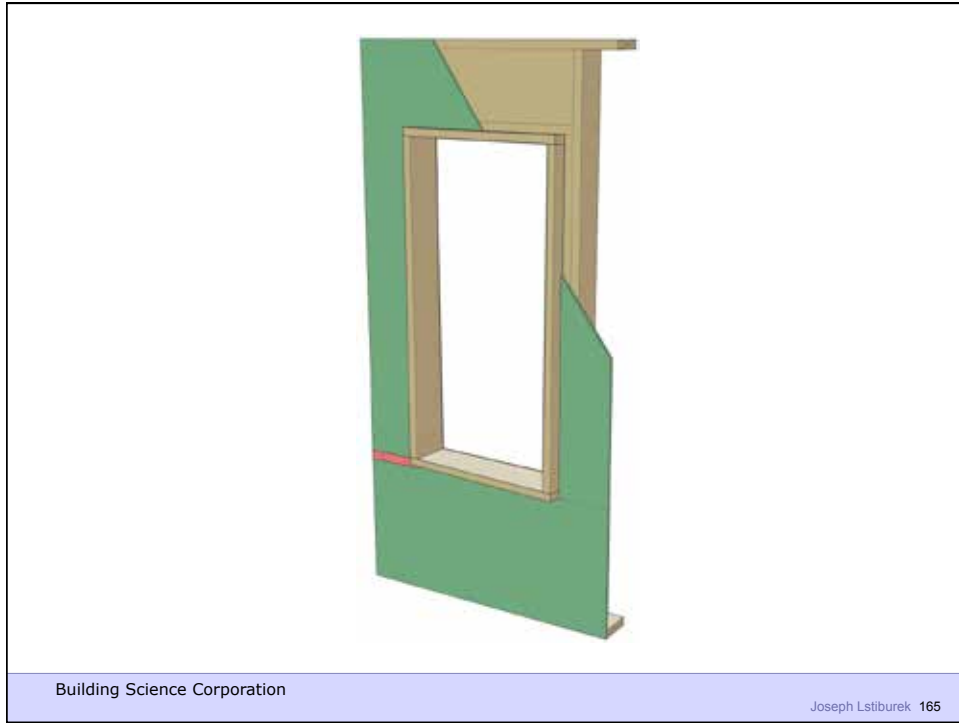

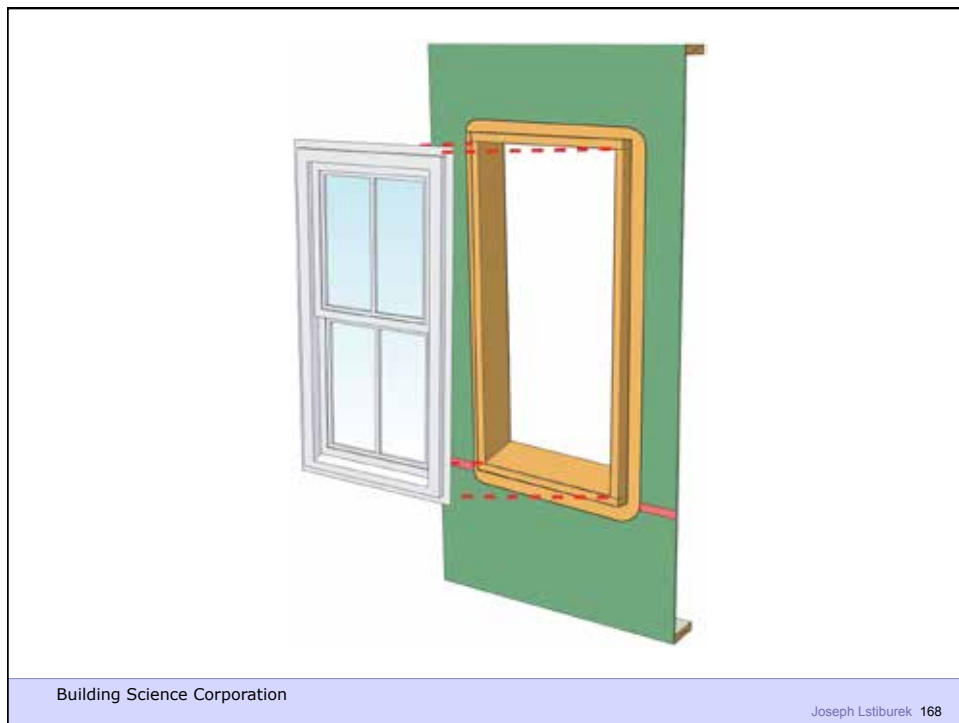
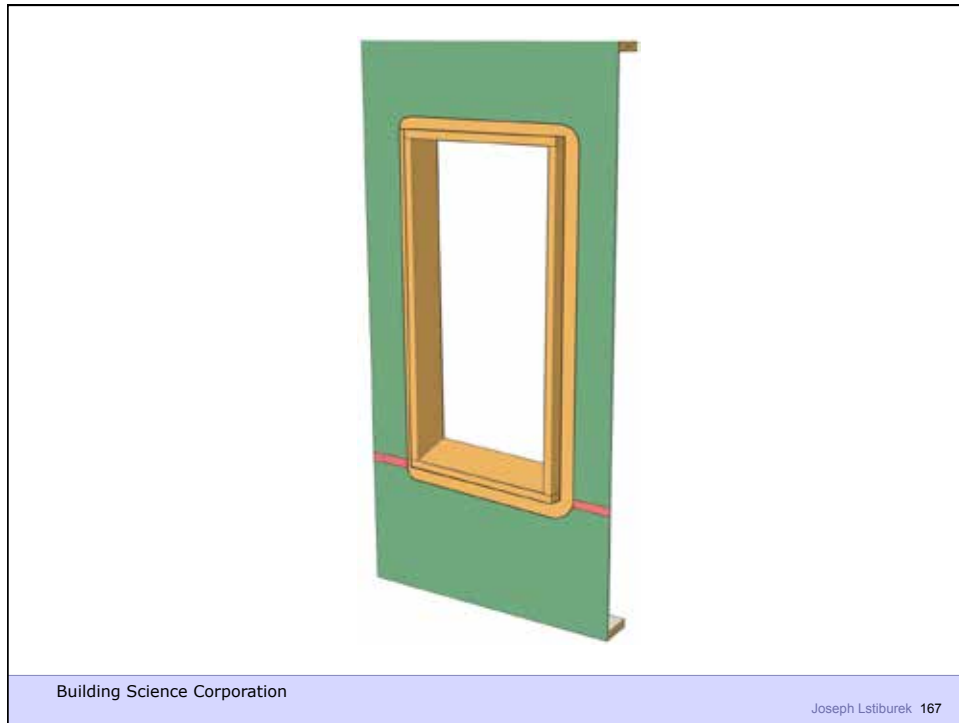





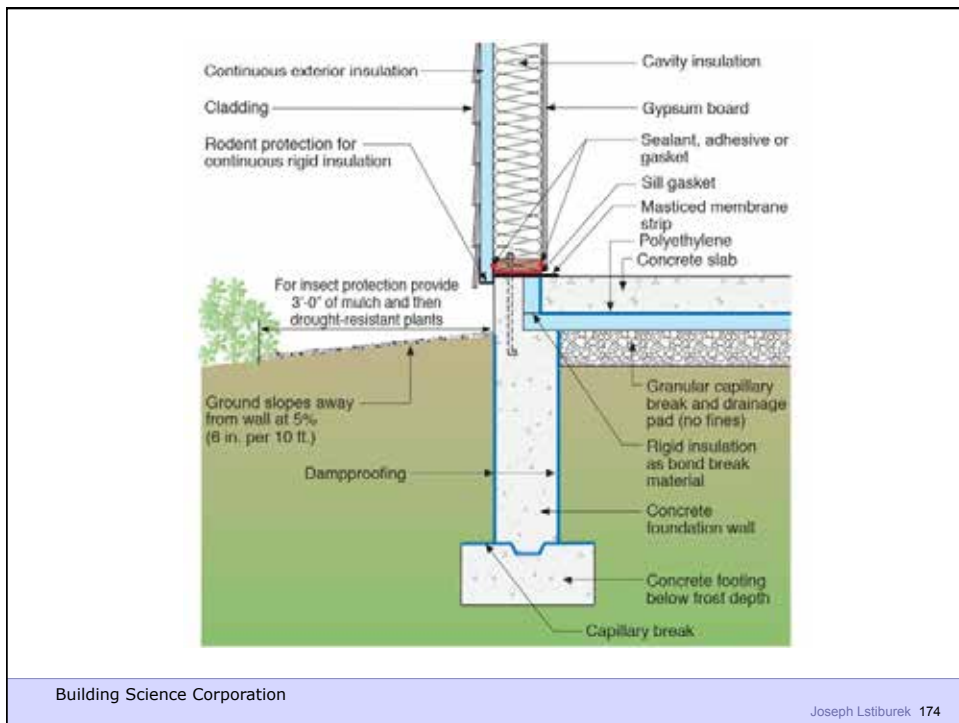

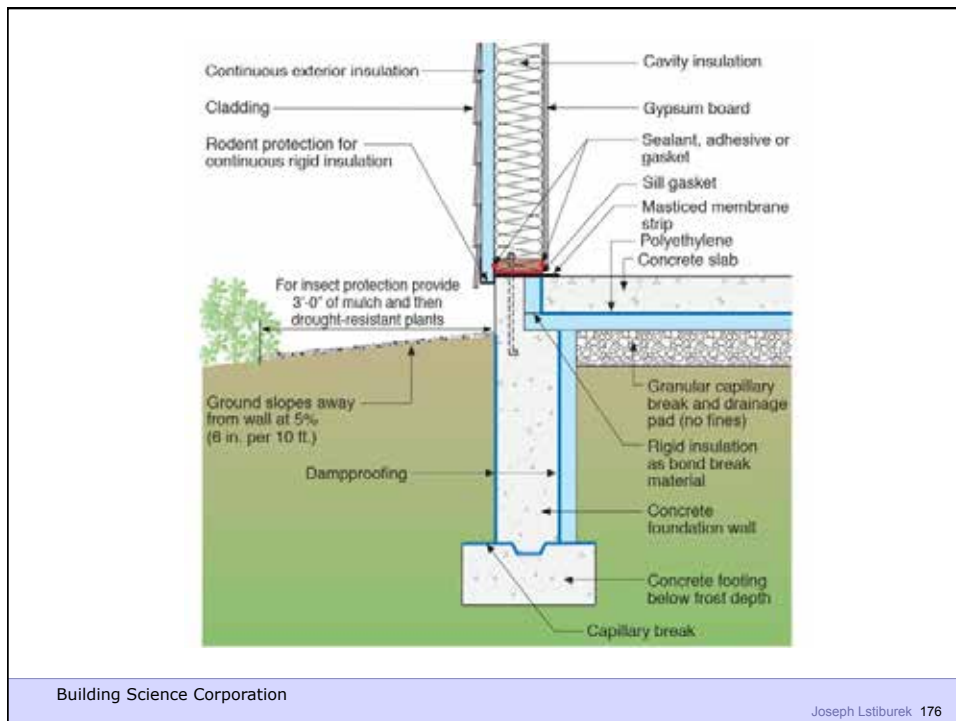
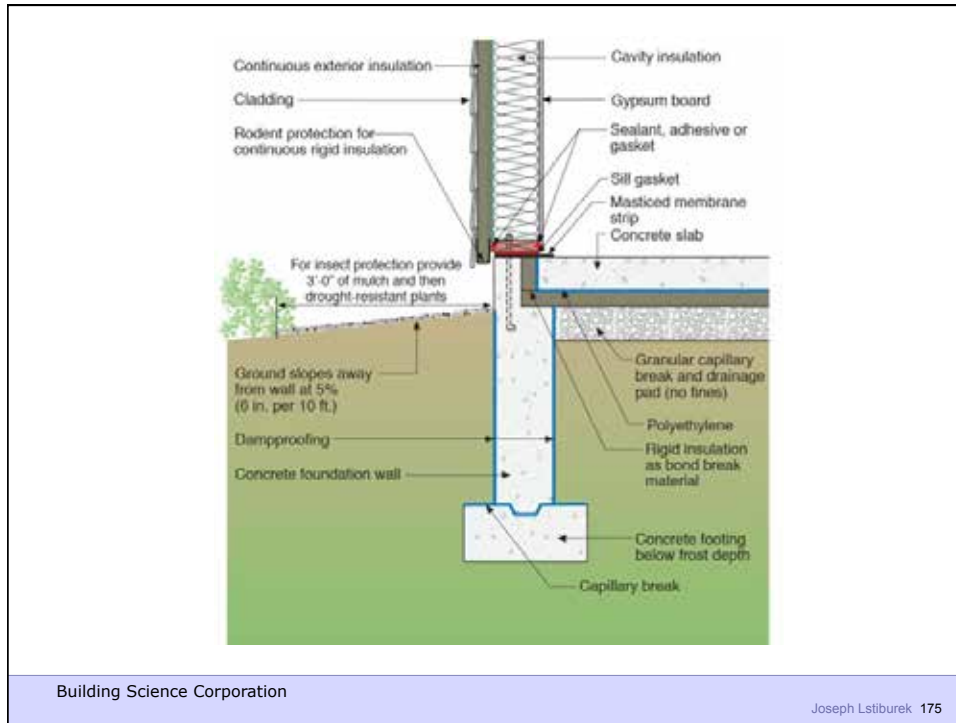

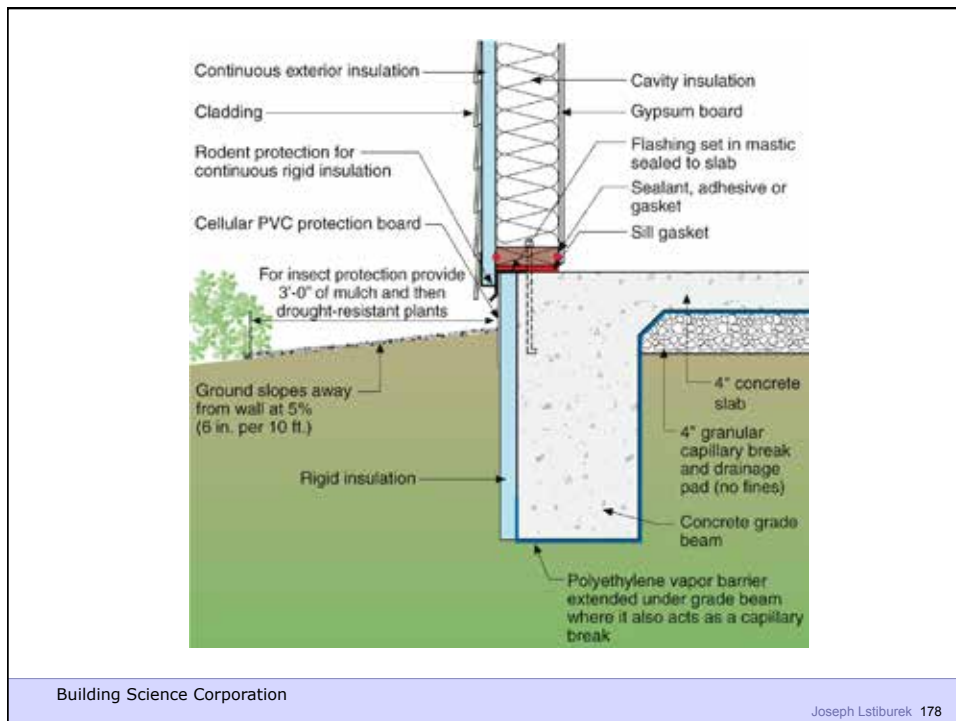
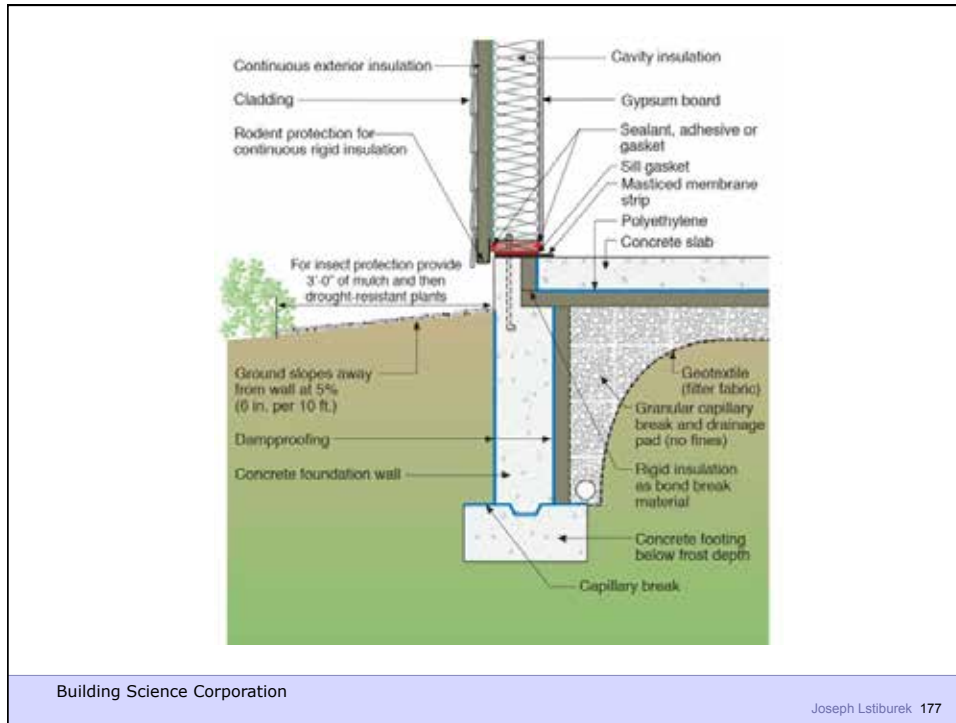

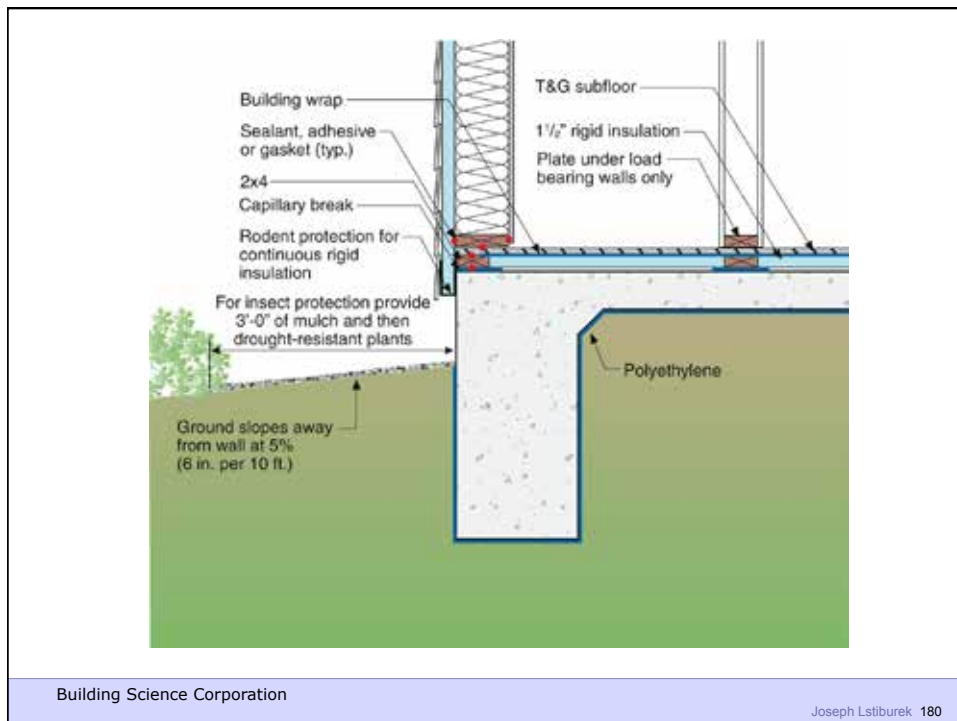
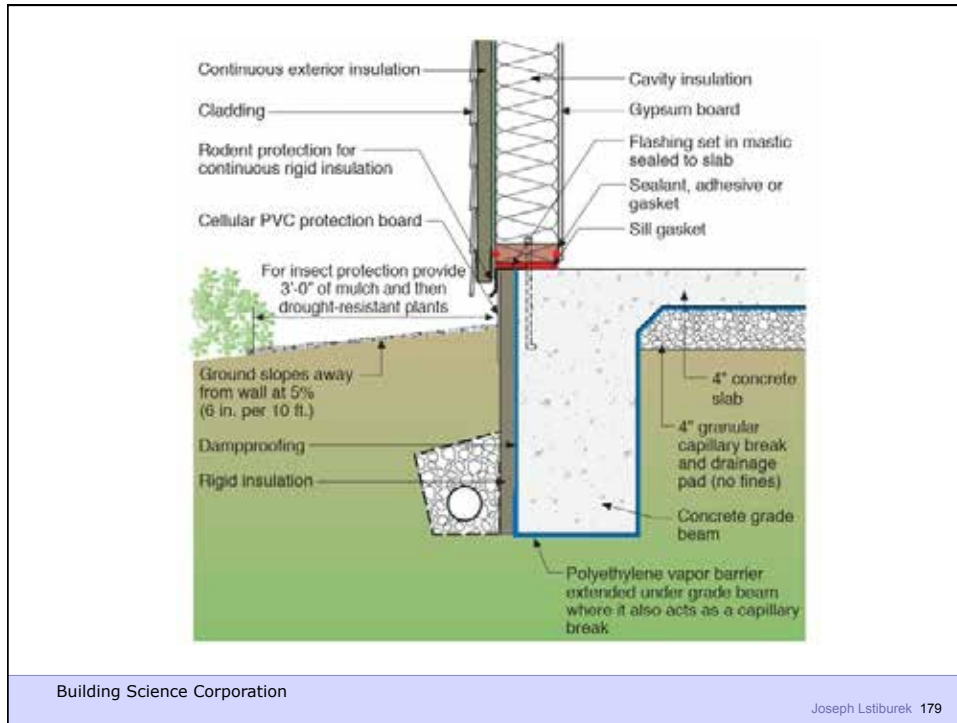

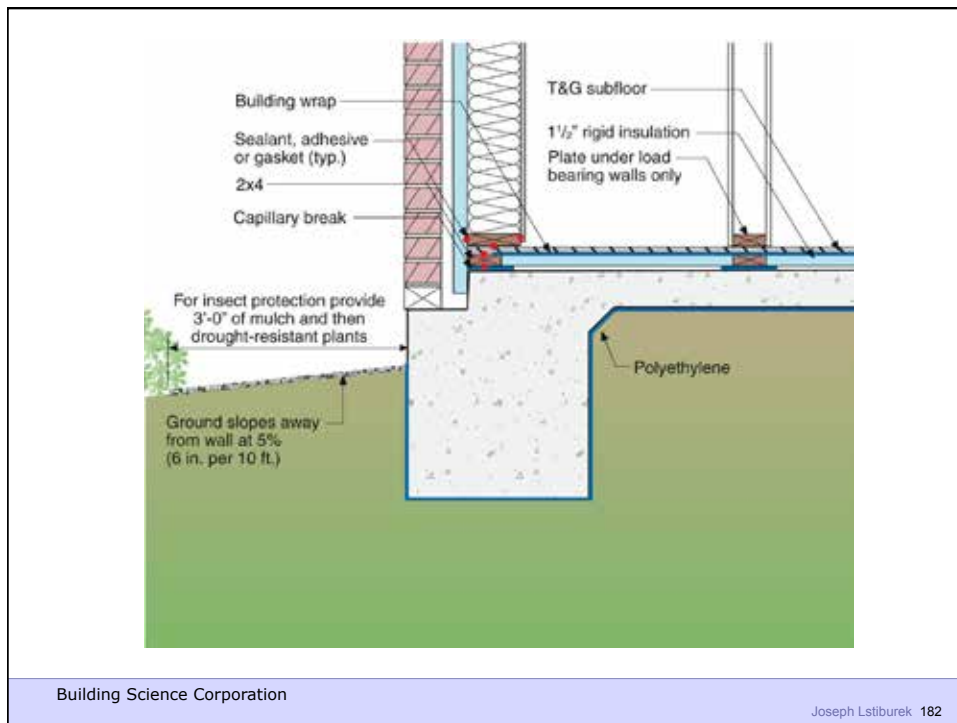
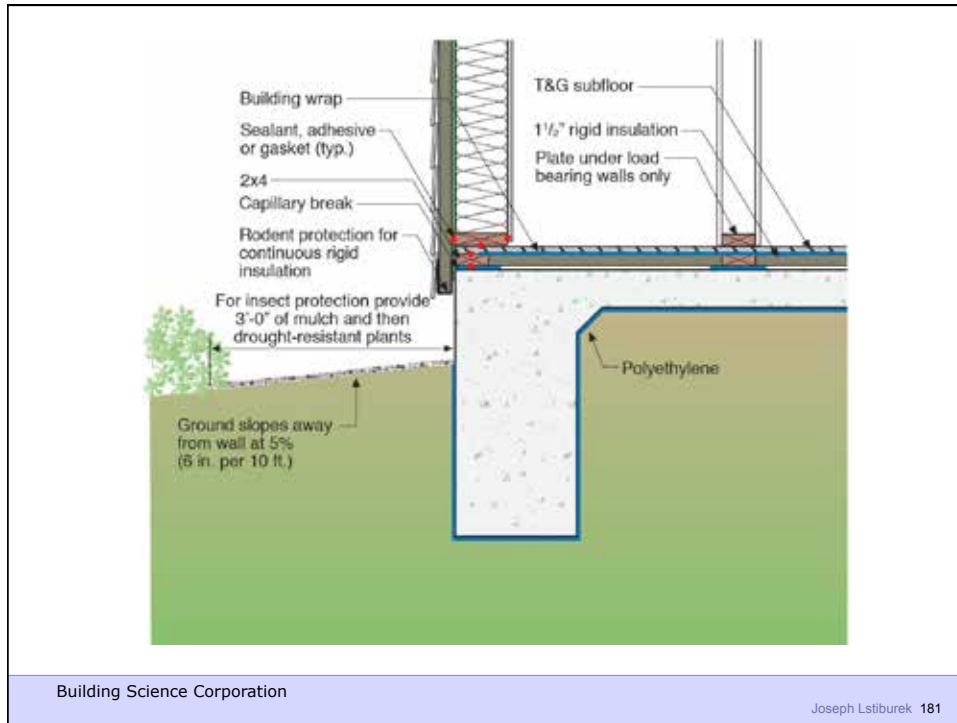

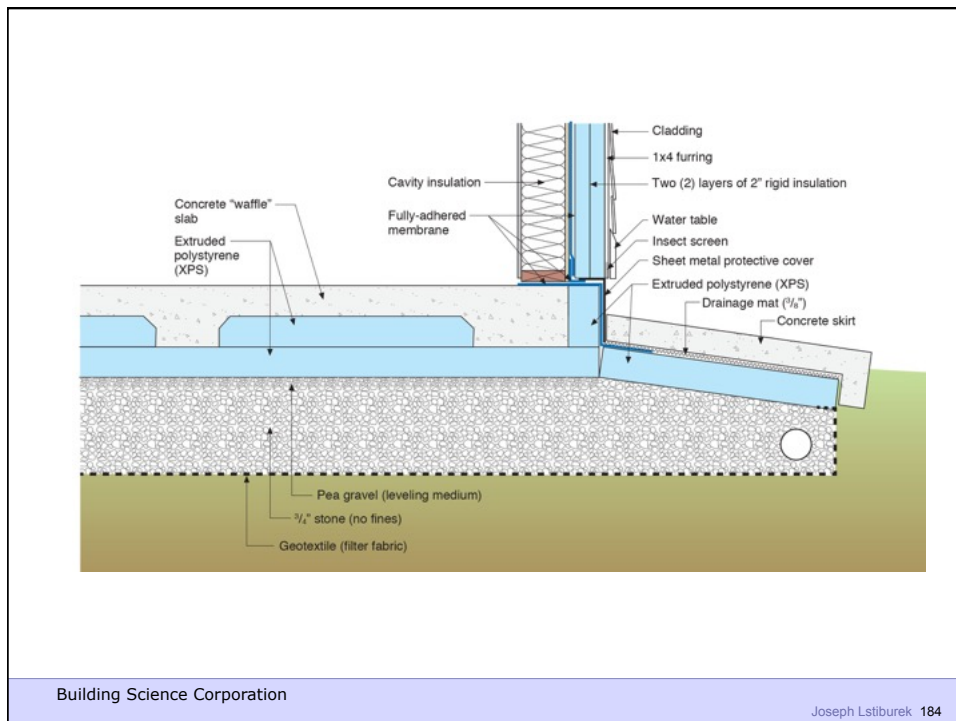
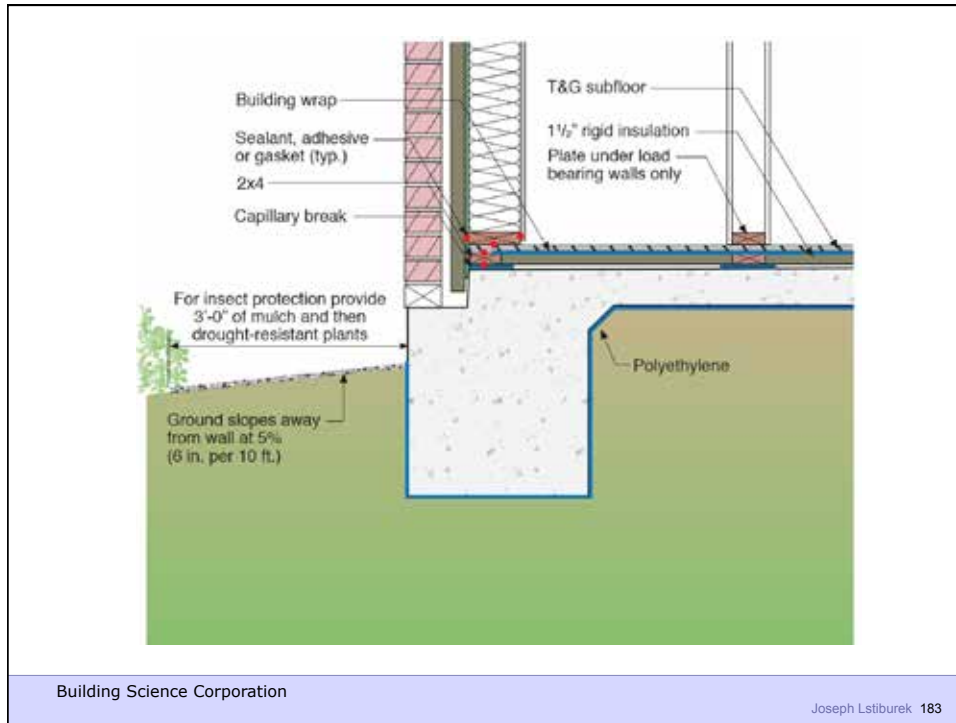

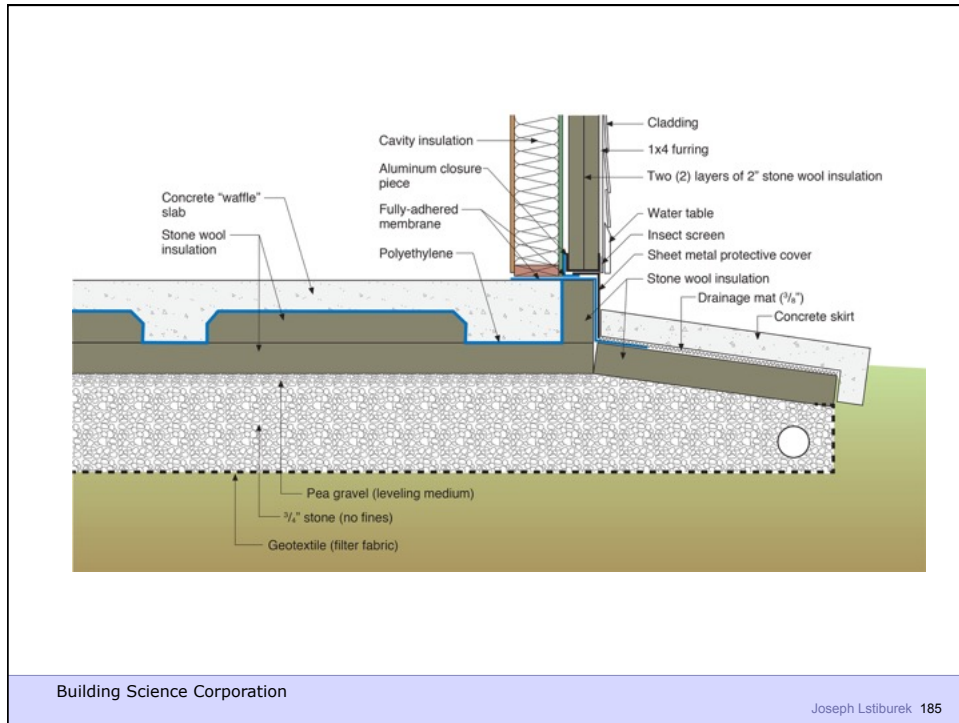



Building Science Corporation

Joseph Lstiburek 187



Building Science Corporation

Joseph Lstiburek 188



Building Science Corporation

Joseph Lstiburek 189

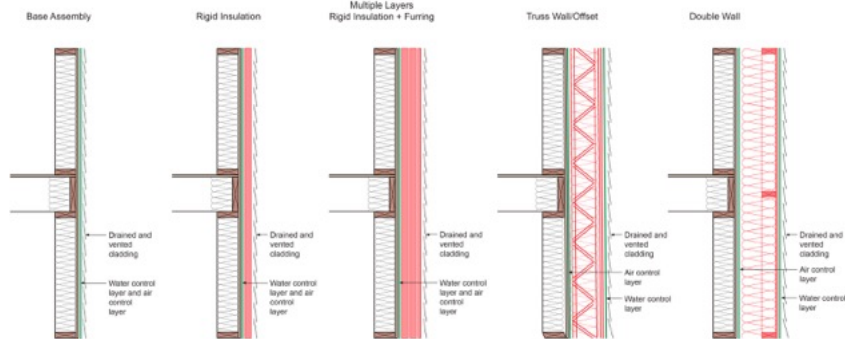

Building Science Corporation

Joseph Lstiburek 190

Mechanical Systems

Building Science Corporation

Joseph Lstiburek 191

Mechanical Systems Cooling System To Make It Cold

Building Science Corporation

Joseph Lstiburek 192

Mechanical Systems
Cooling System To Make It Cold
Dehumidification System To Make It Dry

Mechanical Systems
Cooling System To Make It Cold
Dehumidification System To Make It Dry
Heating System To Make It Warm

Mechanical Systems

Cooling System To Make It Cold

Dehumidification System To Make It Dry

Heating System To Make It Warm

Energy Recovery System To Keep It Cold
and Dry and Warm and Comfortable

Mechanical Systems

Cooling System To Make It Cold

Dehumidification System To Make It Dry

Heating System To Make It Warm

Energy Recovery System To Keep It Cold
and Dry and Warm and Comfortable

Distribution System To Make It Uniform

Mechanical Systems

Cooling System To Make It Cold

Dehumidification System To Make It Dry

Heating System To Make It Warm

Energy Recovery System To Keep It Cold
and Dry and Warm and Comfortable

Distribution System To Make It Uniform

Range Hoods Are A Special Kind of Hell

Don't Try to Combine Them.....

