

**The Garland Company** 

**AIM HIGH** A seminar.  
CREATING HIGH PERFORMANCE BUILDINGS



Presented by:  
John Straube Ph.D. P.Eng.

[www.BuildingScience.com](http://www.BuildingScience.com)

 Building Science Corporation

Solid masonry 

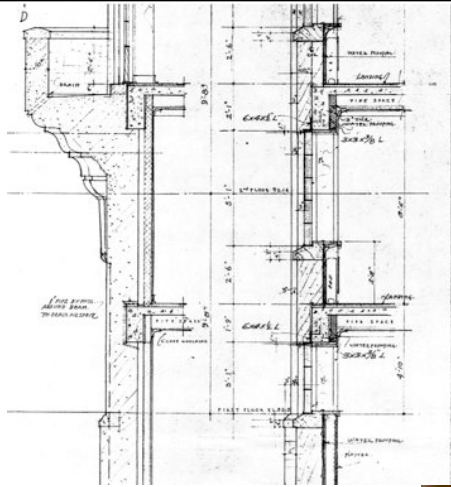
Building Science.com 2

 **Wet Applied Plaster** 

Building Science.com 3

 **Old Growth Timber**

Building Science.com 4

## Pre-WWII Buildings

- No added insulation (or very little)
- Heating systems and some natural ventilation
- No air conditioning
- No vapor barriers
- Few explicit air-tightening or “draft-stopping” details
- Masonry and old-growth solid timber structures
- Plaster is the dominant interior finish

Building Science.com

5

## Pre-WWII Buildings

- No added insulation (or very little)
- Heating systems and some natural ventilation
- No air conditioning
- No vapor barriers
- Few explicit air-tightening or “draft-stopping” details
- Masonry and old-growth solid timber structures
- Plaster is the dominant interior finish

Building Science.com

6

## Five Fundamental Changes

1. Increasing Thermal Resistance
2. Changing Permeance of Enclosure Linings
3. Water/Mold Sensitivity of Materials
4. Moisture Storage Capacity
5. 3-D Airflow Networks

Building Science.com

7

## Changes ...

- Expectations are rising
  - Faster design and construction
  - Lower risk of delays / cost over runs
  - Lower operating costs
  - Less energy consumption (Codes)
  - More comfort and better IAQ
- In short ...  
**better buildings at less total cost**

## Changing Performance

- **On-time, on-budget, to code**
  - Safe
  - Healthy
  - Comfortable
- A growing clamor for....
  - Durable
  - Low-energy
  - Maintainable
  - Modifiable
  - Repairable
- All delivered reliably, predictably

www.BuildingScience.com

## Commercial Buildings Energy Use

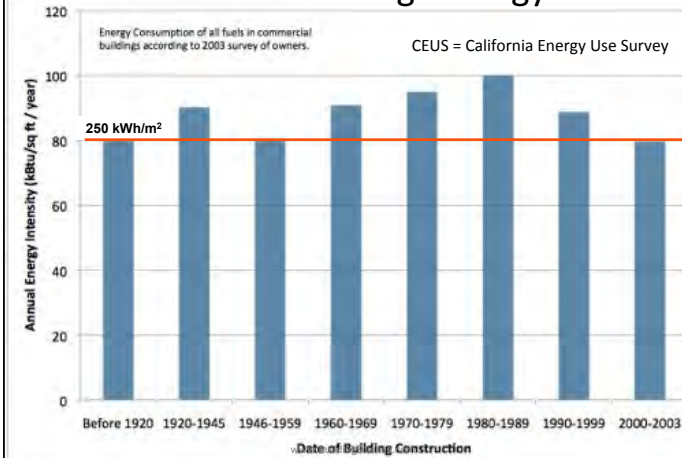

R2



Building Science.com

11

R2



R4



Building Science.com

12

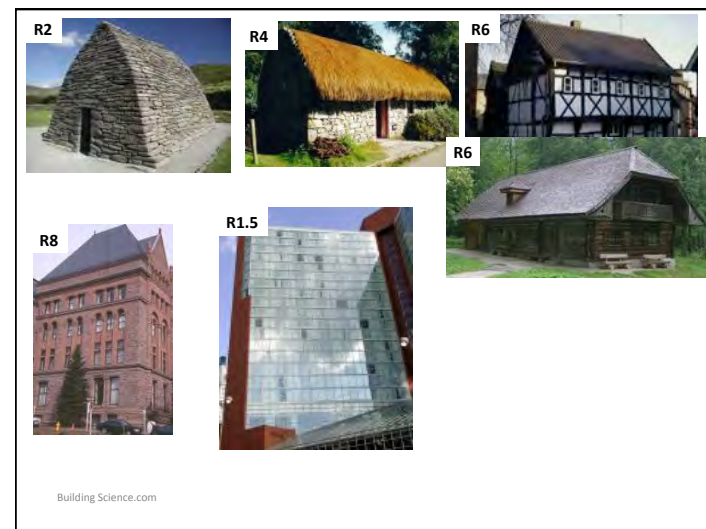
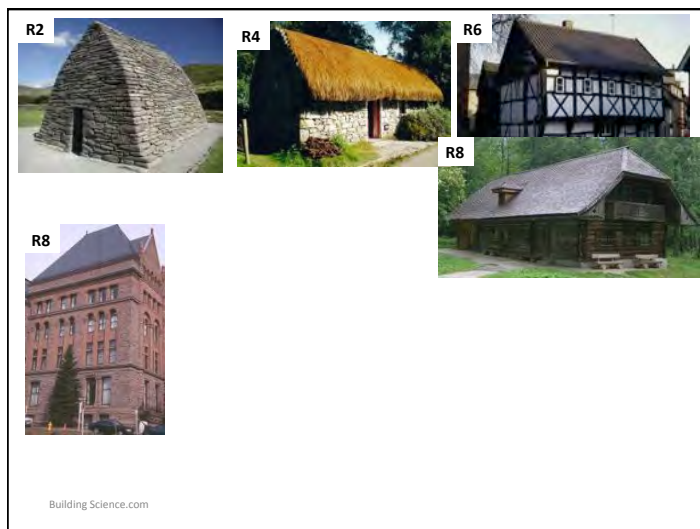
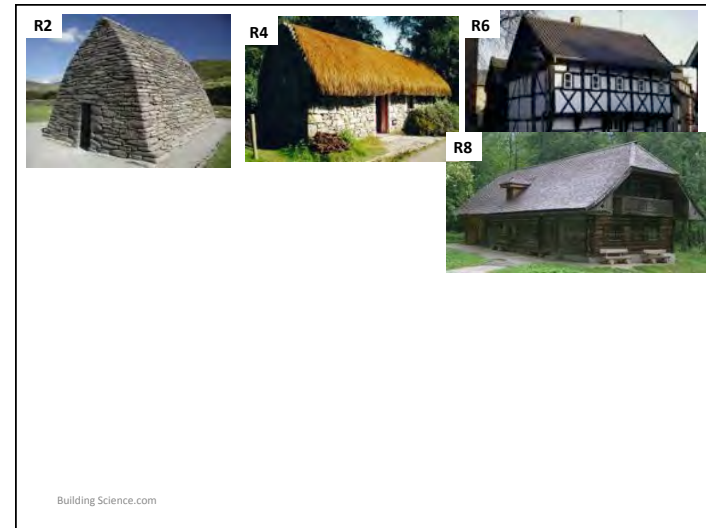
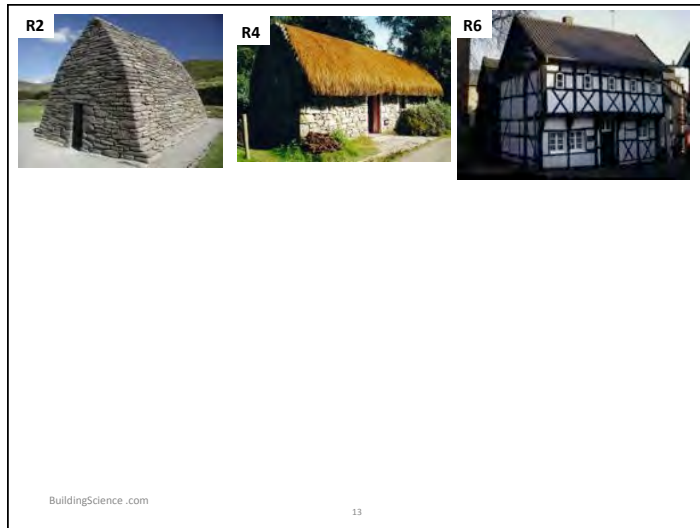

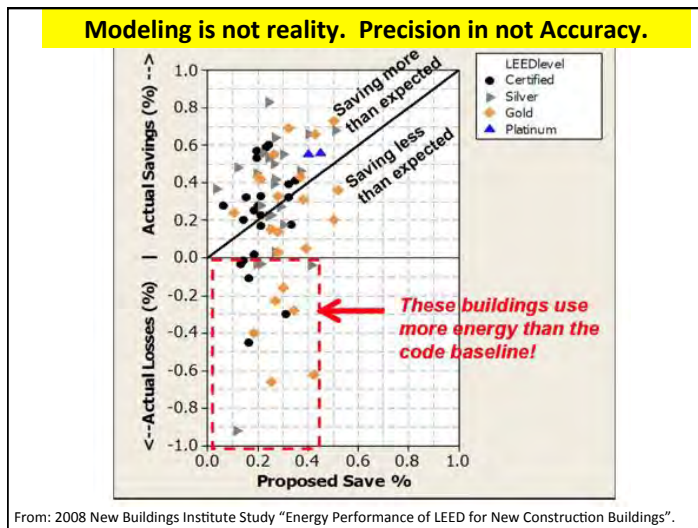
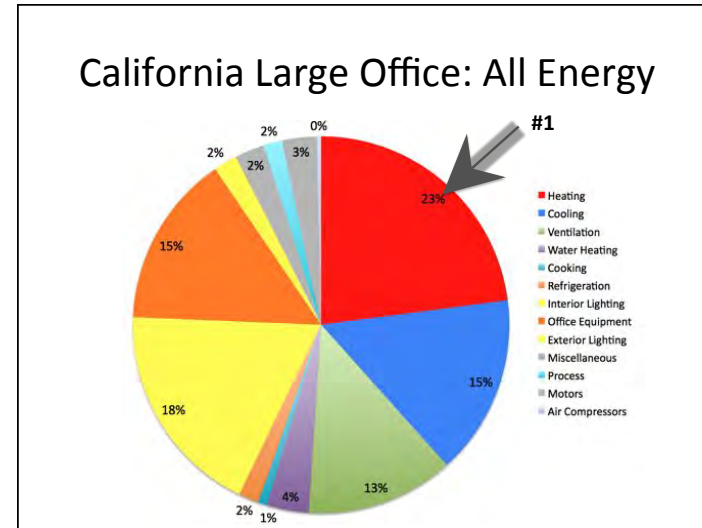
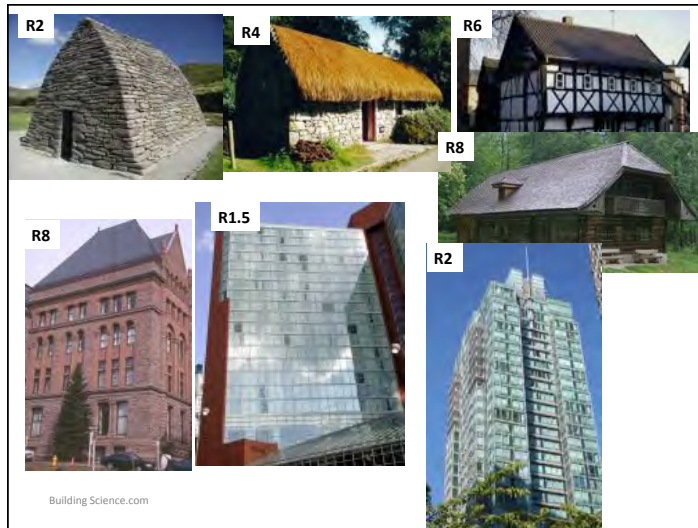

- ### Why such poor performance?
- Not enough insulation, too much air leakage
    - Thermal bridges (windows R3, steel stud R5-R6)
  - Not enough solar control
    - Windows! (too large, overhangs, trees)
  - Too much ventilation
    - And/or poor control of it
  - Too many complex systems
    - HVAC systems no one understands

## Unintended consequences

- Improving enclosure (windows/ roofs) changes things
- Less heat gain
  - = change in AC performance
  - = more condensation
- Less heat flow
  - = less drying
- More airtightness
  - = mech ventilation required

## Complexity

- Modern buildings and systems are complex
  - Good design must manage complexity
  - Allows for focus on the big things
    - e.g., program, massing, quality

**Enclosure and HVAC can be made simpler *and* more robust by early design-stage decisions**

www.BuildingScience.com

## New Solutions

- Step change in performance required
- Different approach to design & construction
  - Target, predict, measure performance
  - Quality assurance/control in drawings, on site
- Different, robust, assemblies and systems
  - More tolerant of operational/construction errors
  - Less complex, easier to manage

## Prescription of High Performance

- Good skin
  - Rain, air, heat, vapor control
  - Simple to understand/analyze assemblies
- Good HVAC
  - Control temperature, RH, Fresh air separately
  - Simple to understand/analyze systems
- Good design
  - Daylight, view, program, enjoyment
  - Assume future changes will occur

## Skin: Enclosures in Context

- Enclosures are key to comfort and durability
- Enclosures **reduce** space heating/cooling
  - and help with lighting, ventilation
- We still need **energy** for other things
  - Dehumidification, cooling, lights, computers, etc
- But
  - **Bad enclosures ruin good HVAC**
  - **Bad HVAC can ruin good enclosures**

[www.BuildingScience.com](http://www.BuildingScience.com)

## This seminar

- Enclosure
  - Roofs
  - Walls
  - Windows
- HVAC - briefly
  - Humidity
  - Ventilation
  - Energy

## Enclosure Design Principles



[www.buildingscience.com](http://www.buildingscience.com)

## The Enclosure: An Environmental Separator

- The part of the building that physically **separates** the **interior** and **exterior** environments.
- Includes all of the parts that make up the wall, window, roof, floor, caulked joint etc.
- Sometimes, interior partitions also are environmental separators (pools, rinks, etc.)

Building Science

Enclosures No. 28 /

## Climate Load Modification

- Building & Site (overhangs, trees...)
  - Creates microclimate
- Building Enclosure (walls, windows, roof...)
  - Separates climates
  - Passive modification
- Building Environmental Systems (HVAC...)
  - Use energy to change climate
  - Active modification

## Basic Functions of the Enclosure

- 1. Support
    - Resist and transfer physical forces from inside and out
  - 2. Control
    - Control mass and energy flows
  - 3. Finish
    - Interior and exterior surfaces for people
- Distribution – a building function

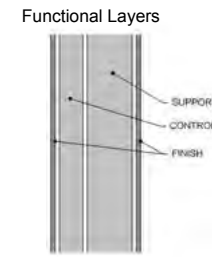

Building Science

## Basic Enclosure Functions

- **Support**
  - Resist & transfer physical forces from inside and out
    - Lateral (wind, earthquake)
    - Gravity (snow, dead, use)
    - Rheological (shrink, swell)
    - Impact, wear, abrasion
- **Control**
  - Control mass and energy flows
- **Finish**
  - Interior and exterior surfaces for people

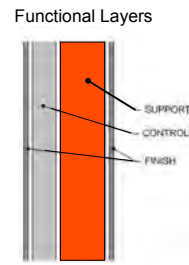

Building Science

Enclosures No. 31 /

## Basic Enclosure Functions

- **Support**
  - Resist & transfer physical forces from inside and out
- **Control**
  - Control mass and energy flows
    - Rain (and soil moisture)
      - Drainage plane, capillary break, etc.
    - Air
      - Continuous air barrier
    - Heat
      - Continuous layer of insulation
    - Vapor
      - Balance of wetting/drying
- **Finish**
  - Interior and exterior surfaces for people

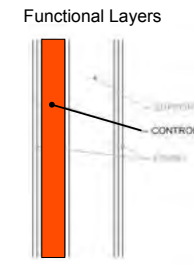

Building Science.com

Enclosures No. 32 /



## Other Control . . .

- Support
- **Control**
  - Fire
    - Penetration
    - Propagation
  - Sound
    - Penetration
    - Reflection
  - Light
    - Diffuse/glare
    - View
- Finish

Functional Layers

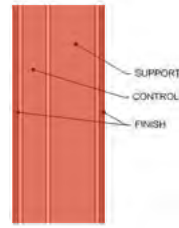

Building Science.com

Enclosures No. 33 /

## Basic Enclosure Functions

- Support
  - Resist & transfer physical forces from inside and out
- Control
  - Control mass and energy flows
- **Finish**
  - Interior & exterior surfaces for people
    - Color, speculance
    - Pattern, texture

Functional Layers

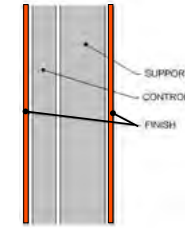

Building Science.com

## History of Control Functions

- Older Buildings
  - One layer does everything
- Newer Building
  - Separate layers, . . . separate functions



Building Science.com

No. 35

## Changes

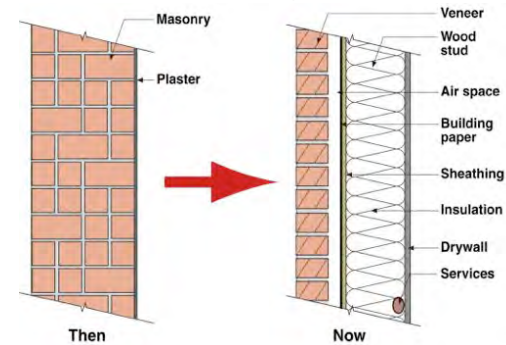

Building Science.com

36

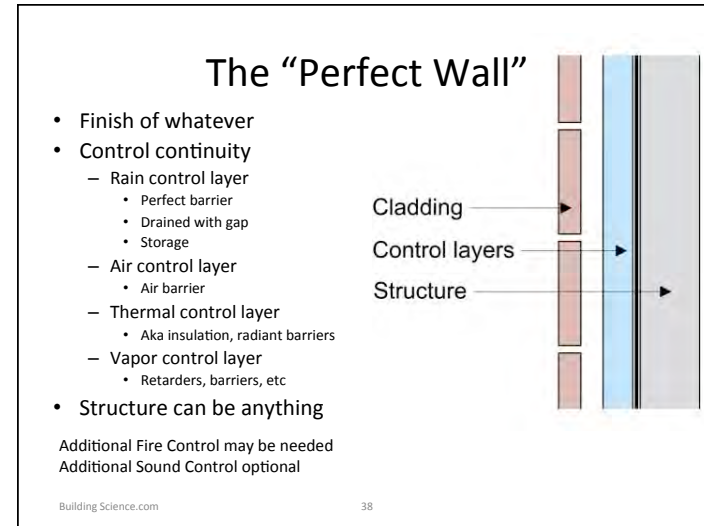
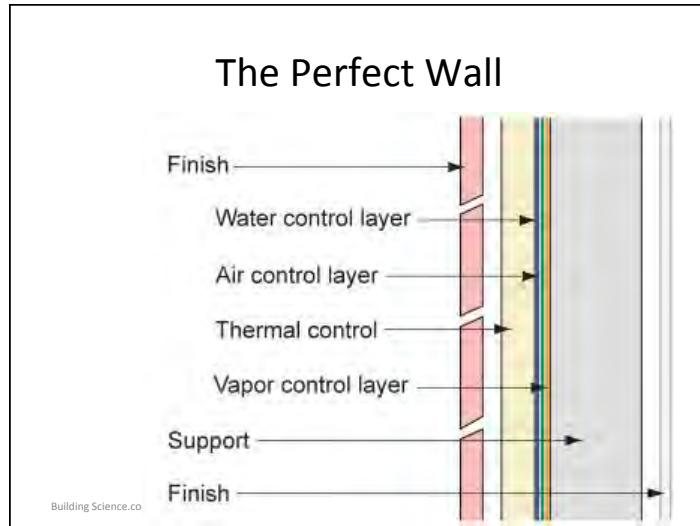

### What is a high performance enclosure?

- High levels of control
- **But**, poor continuity limits performance
- **&** Poor continuity causes most problems too:
  - E.g. air leakage condensation
  - Rain leakage
  - Surface condensation
  - Cold windows
- Thus: *continuity + high levels of control*

www.BuildingScience.com

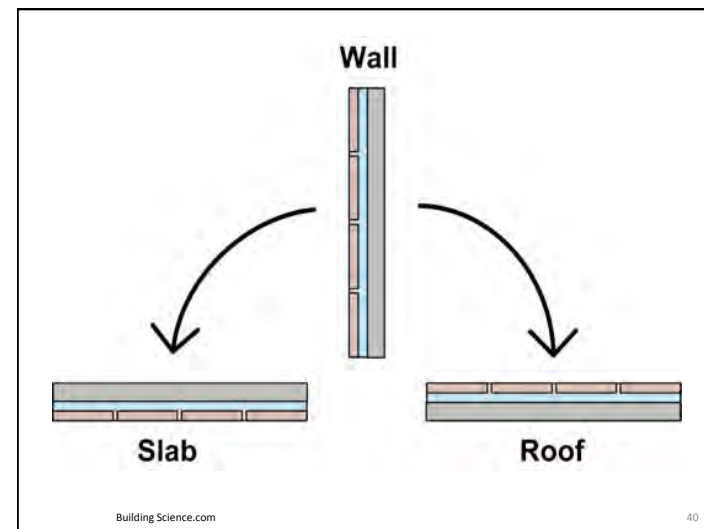

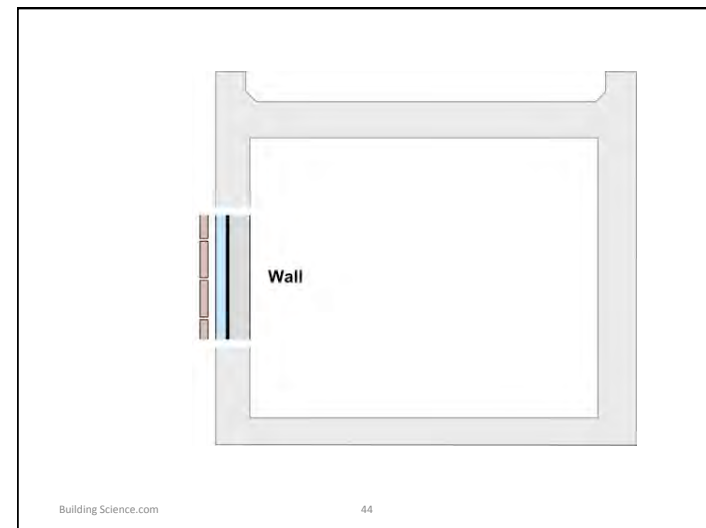
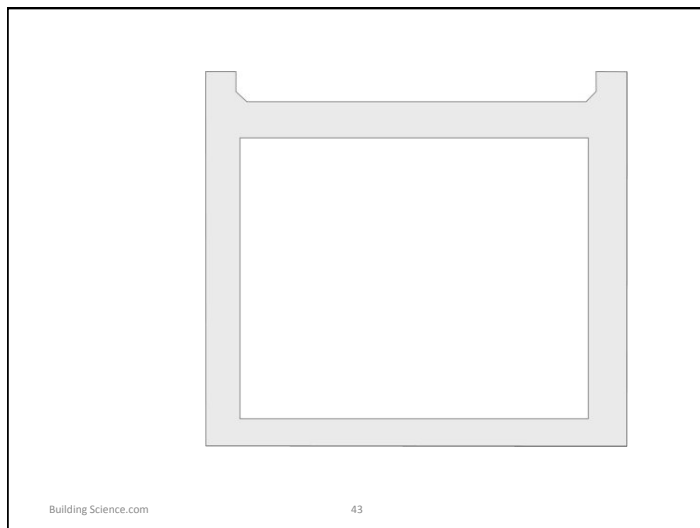
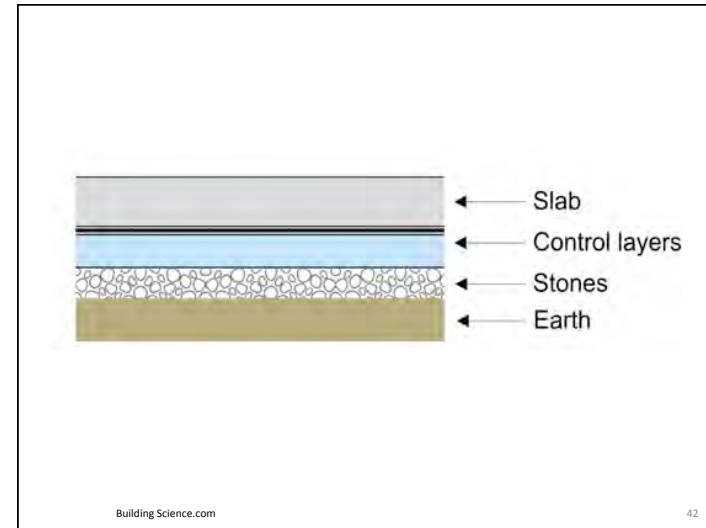
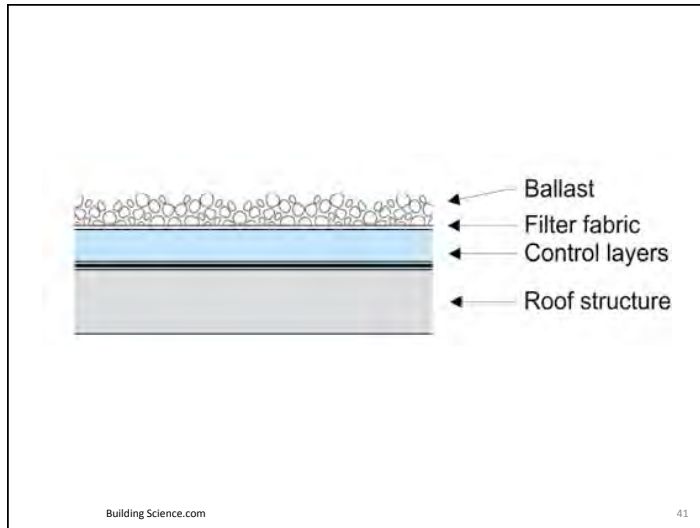

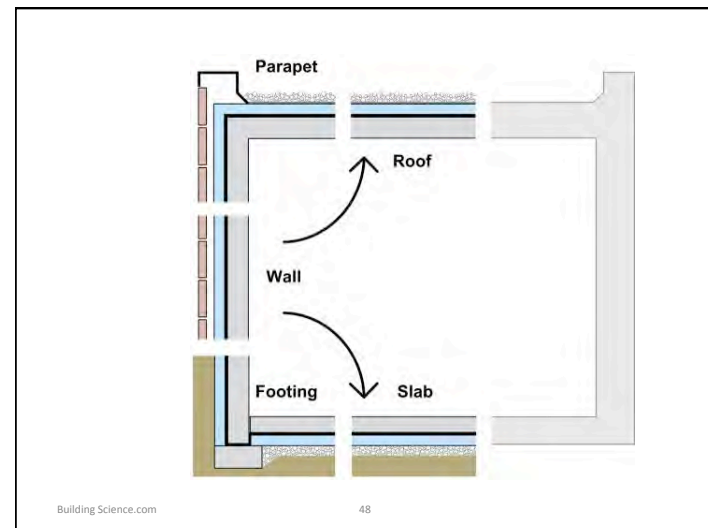
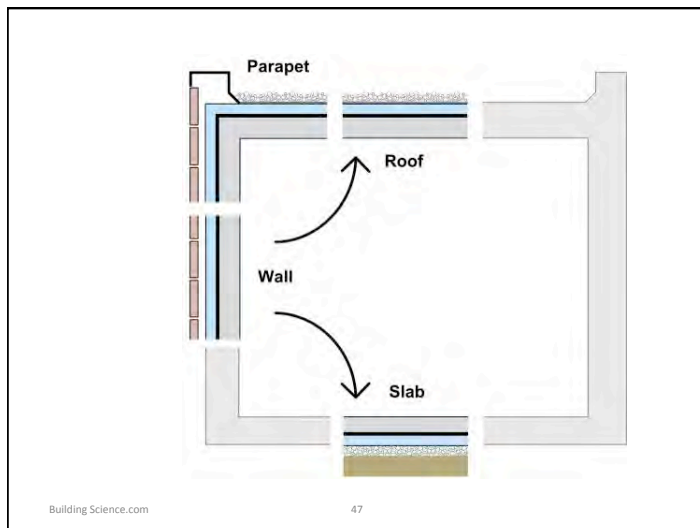
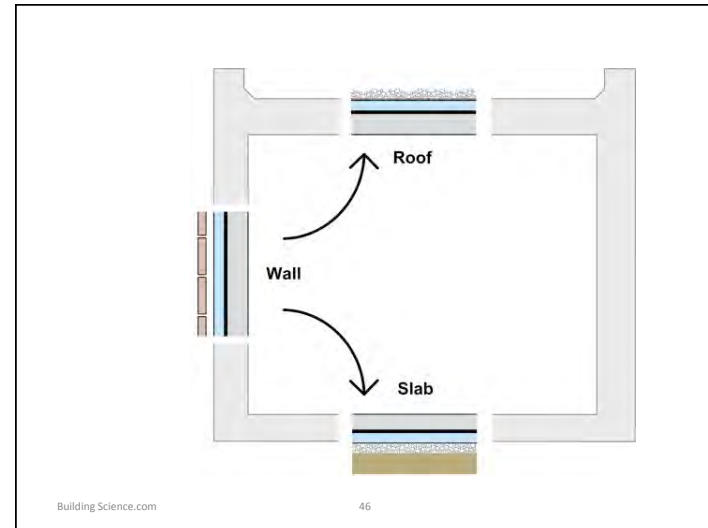
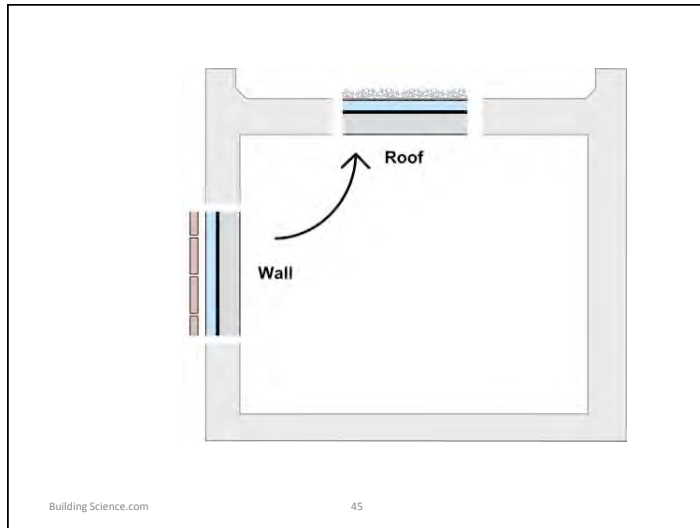

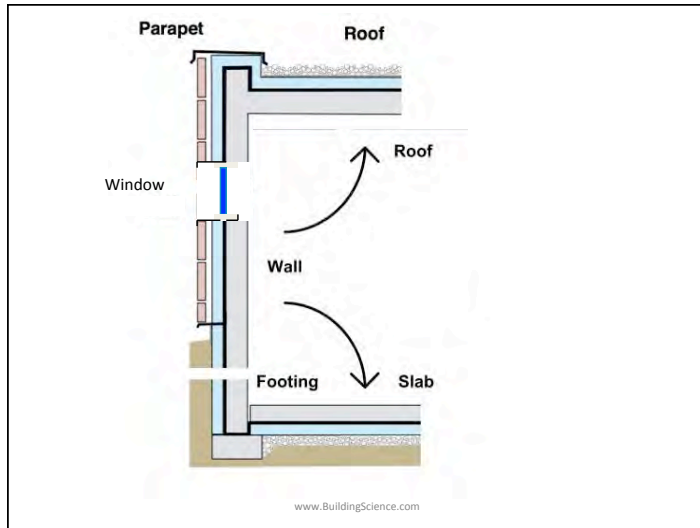

### Enclosure Design: Details

- Details demand the same approach as the enclosure.
- Scaled drawings required at ○
  - change in plane
  - change in material
  - change in trade

A 3D perspective model of a building corner, showing multiple levels and setbacks. Red circles are placed at various points where the building's geometry changes, such as at the corners of different levels and at window openings. A blue dashed line indicates a vertical section through the building. The website 'Building Science.com' and the number '51/175' are visible at the bottom.

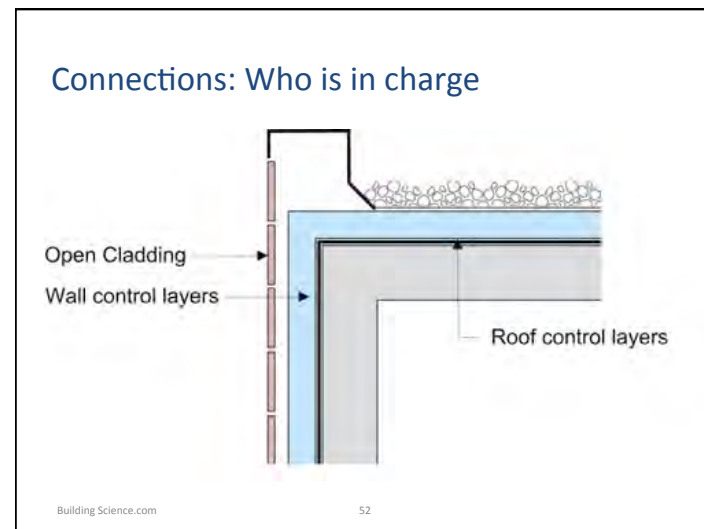

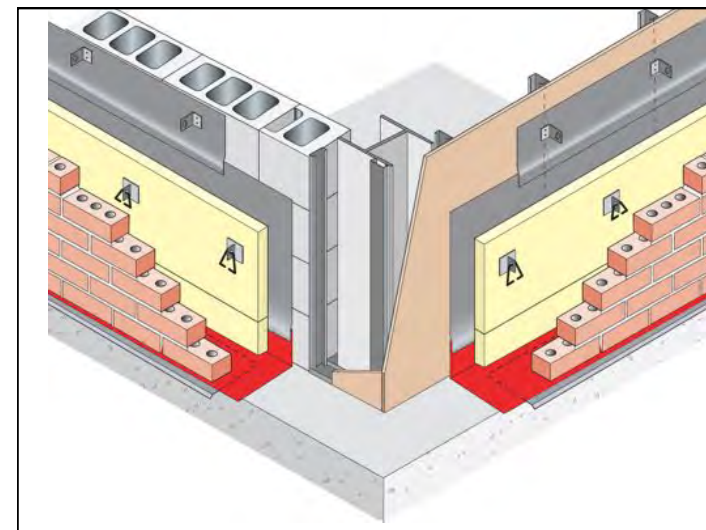
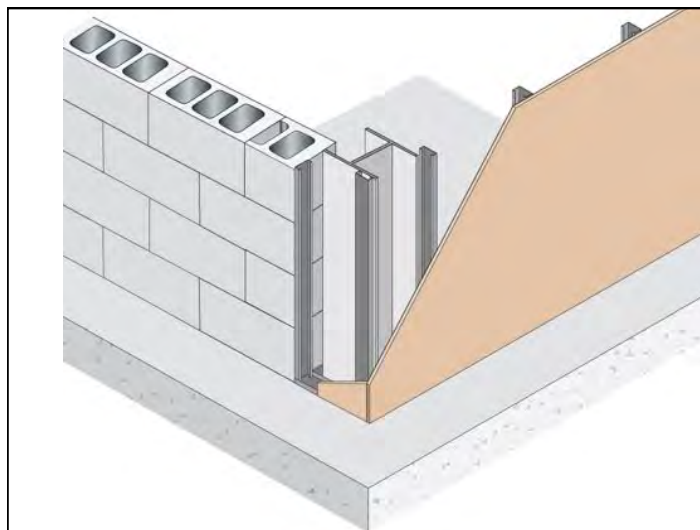
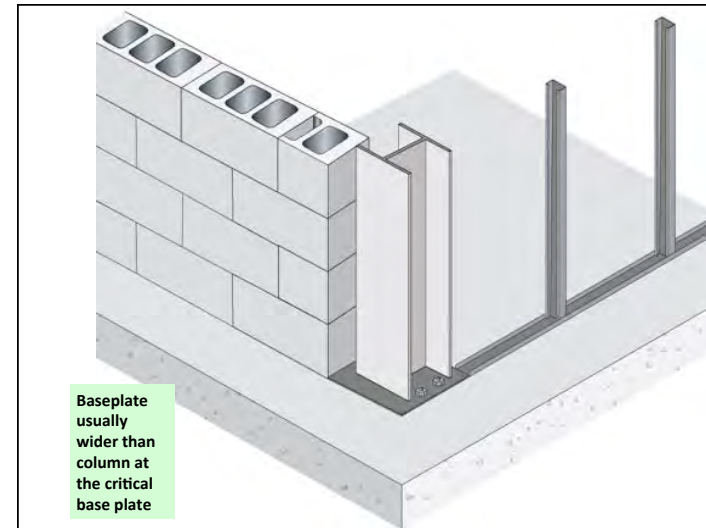
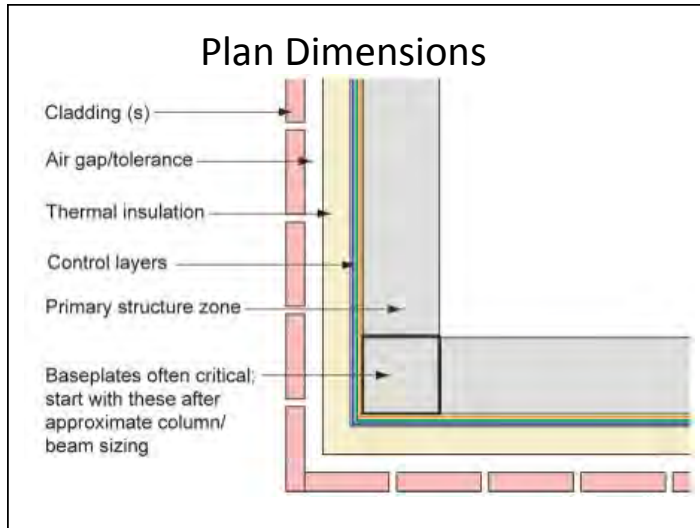

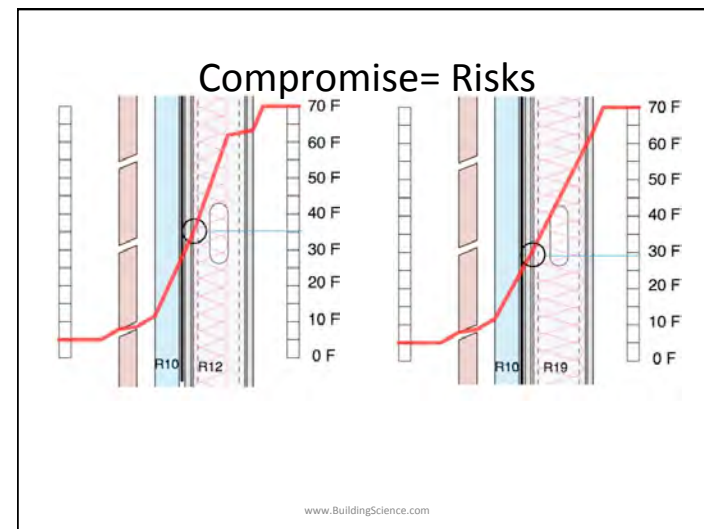
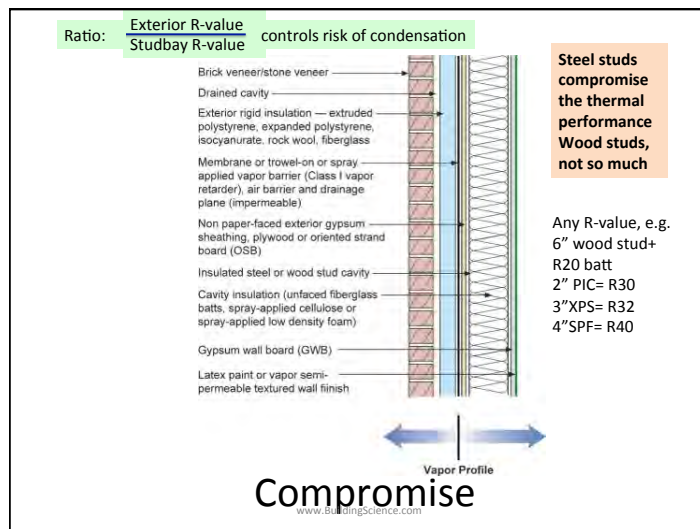
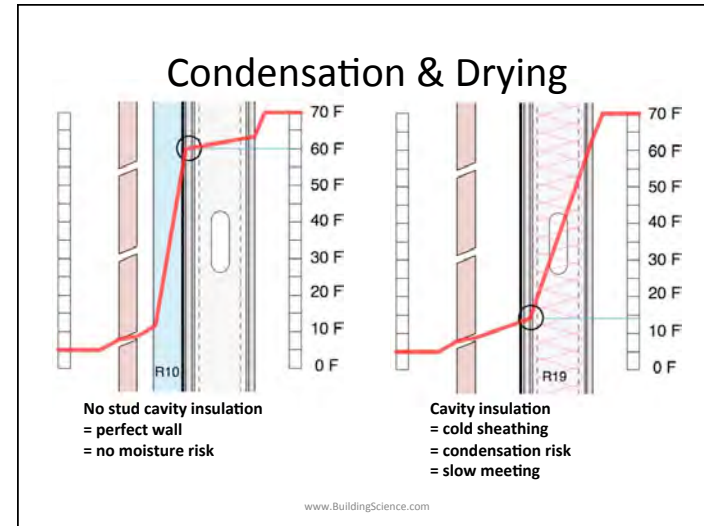
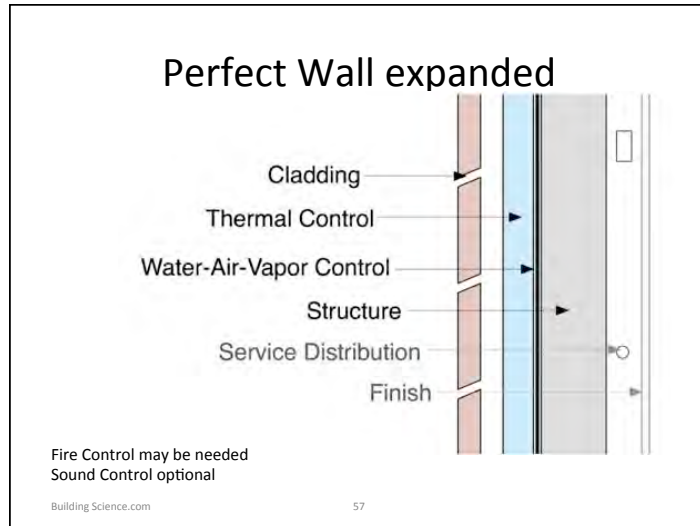



### Continuity is key!

- Must ensure no rain leaks, no holes
- Airflow control should be as continuous as practical
- Thermal control
  - We live with penetrations
  - Minimize steel & concrete to small local points
- Vapor control
  - Not that important to ensure continuity

**Energy**

www.BuildingScience.com

### Next Steps

- 1. Rain Control
  - most important
- 2. Air Control
  - Energy, health, humidity
- 3. Thermal Control
  - Solar shading
  - Thermal bridging

Can be separate Or Combined in same material

### 1. Rain Control

Wall System<sup>1</sup>

- Three possible approaches
  - Mass
  - Drained
  - Perfect Barriers
- Element and joint can be different approach
- Perfect Barriers are risky



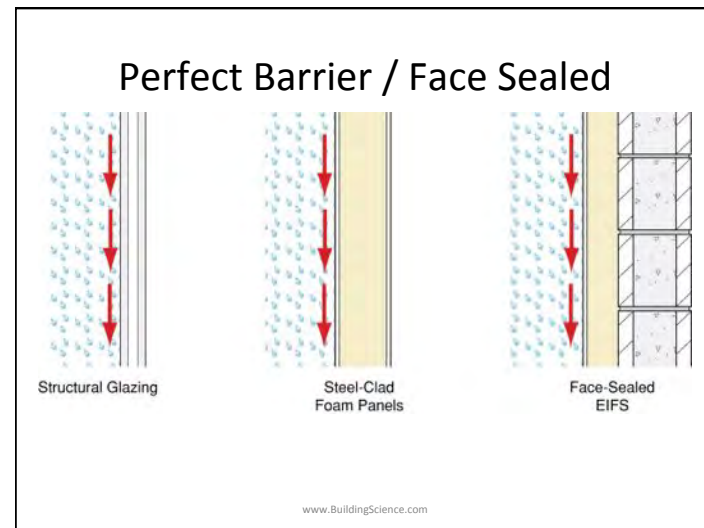
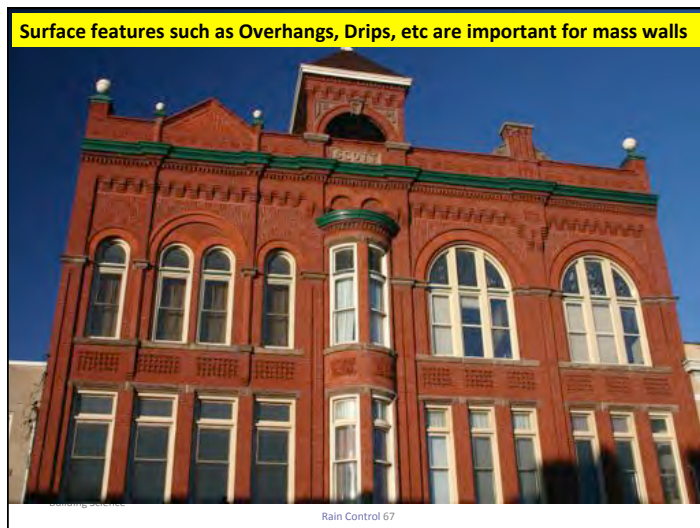
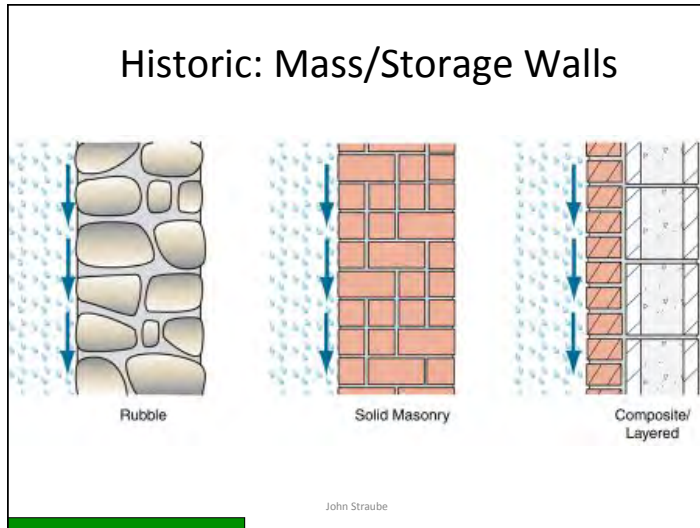

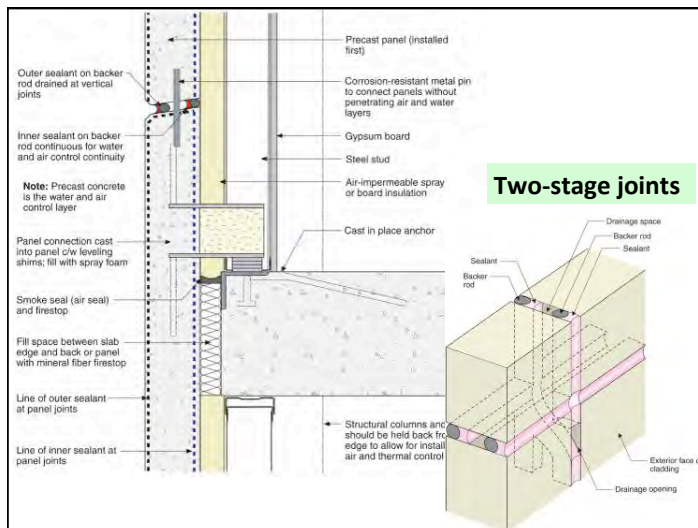
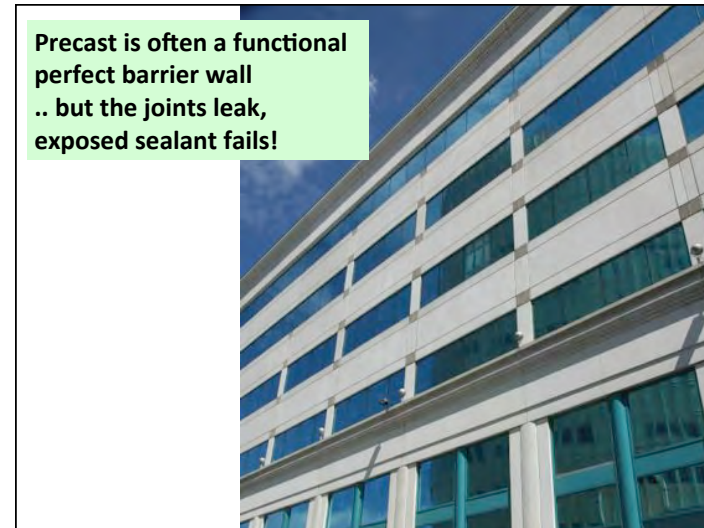

### Drained Walls

- Drained systems preferred
- Account for joints and penetrations as well as installation defects and material failure

Building Science.com 72

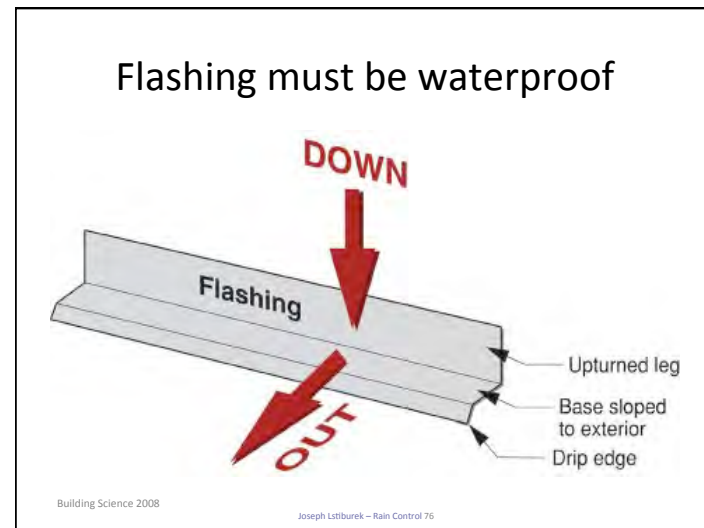
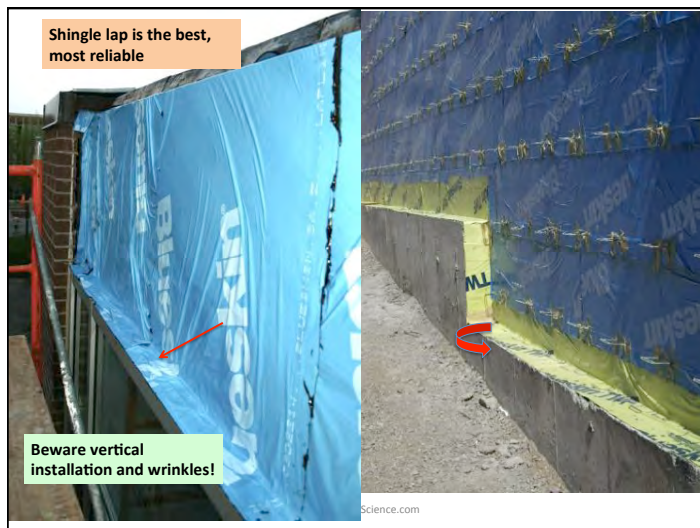
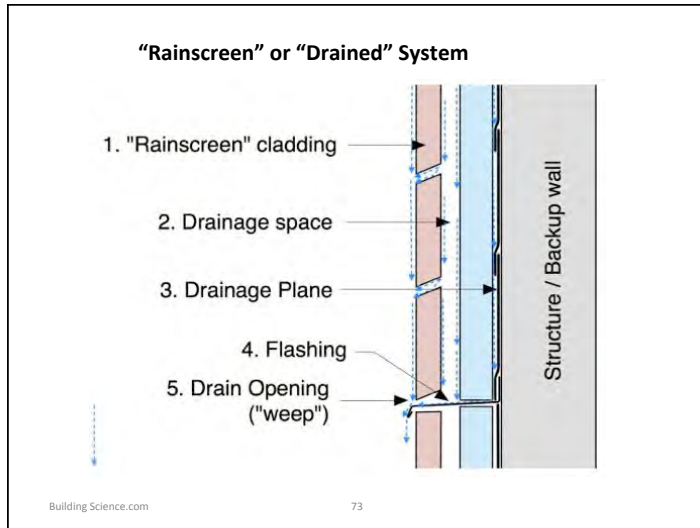

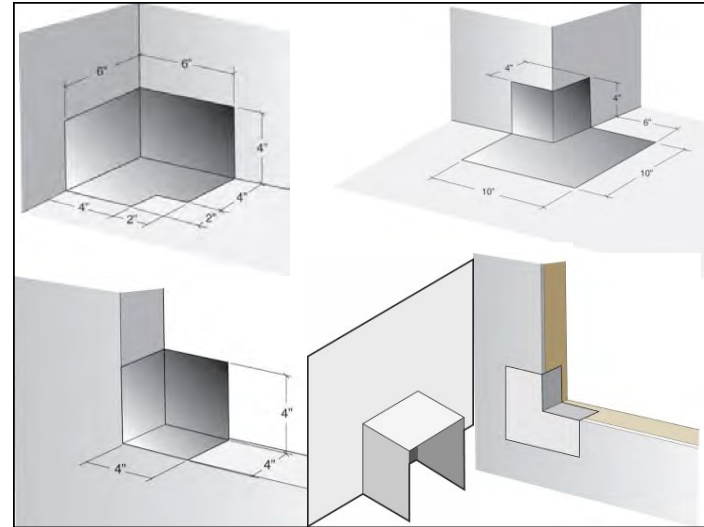
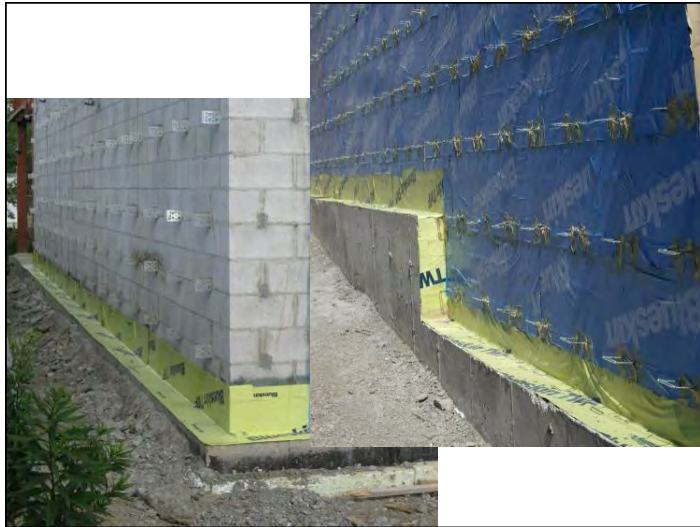

### Windows and Doors

- All penetrations should be drained, regardless of the approach taken to the element
- Windows and doors are the most critical openings to drain
- Rough opening must be drained

### Leaky windows

- Studs and sheathing are sensitive to leaks



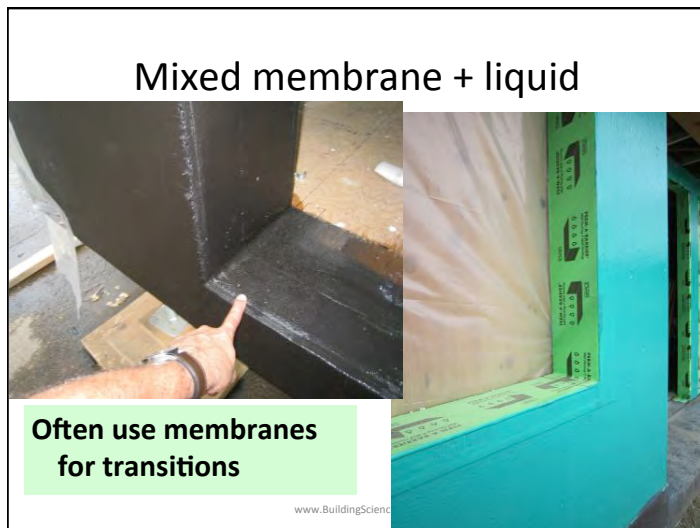
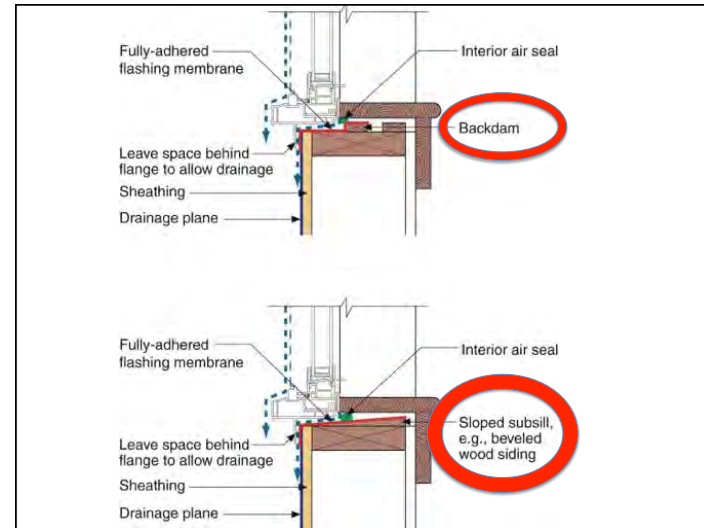
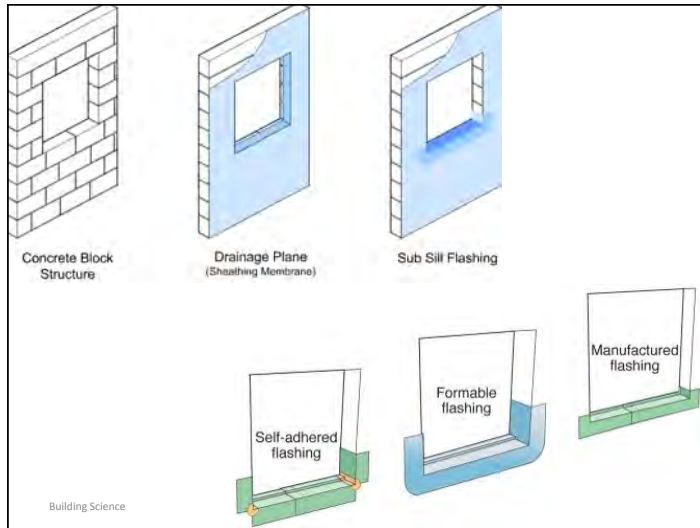

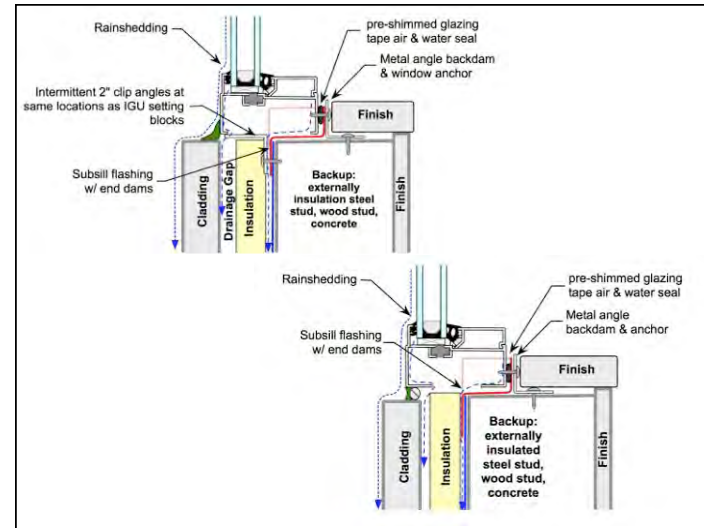
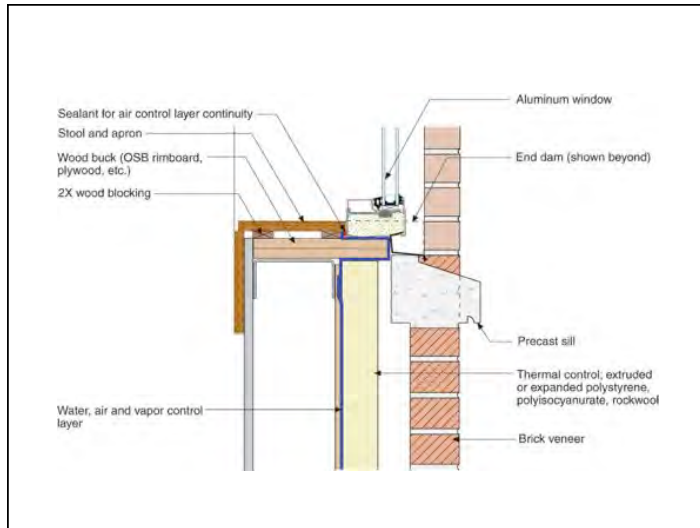

Continuous interior angle provides backdam and airseal continuity

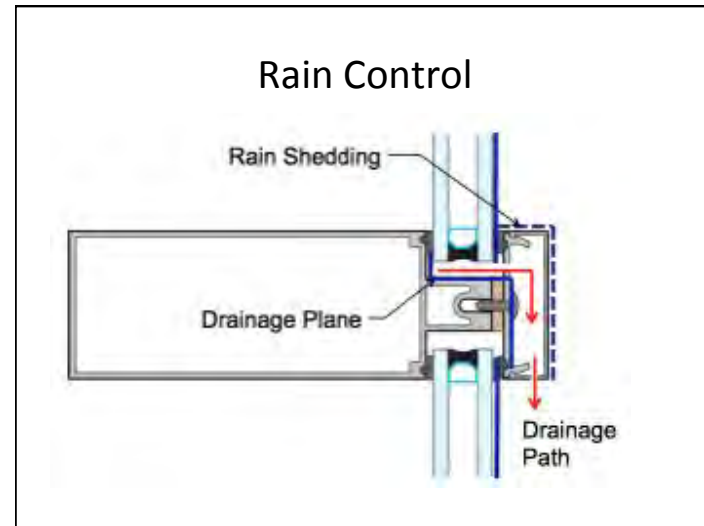

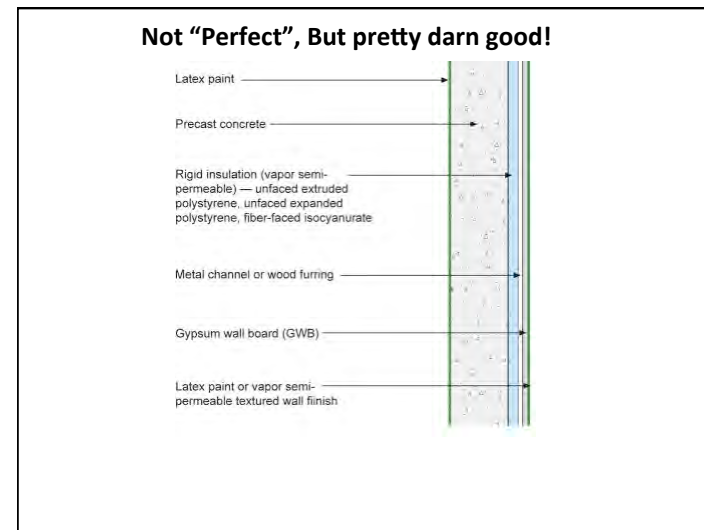
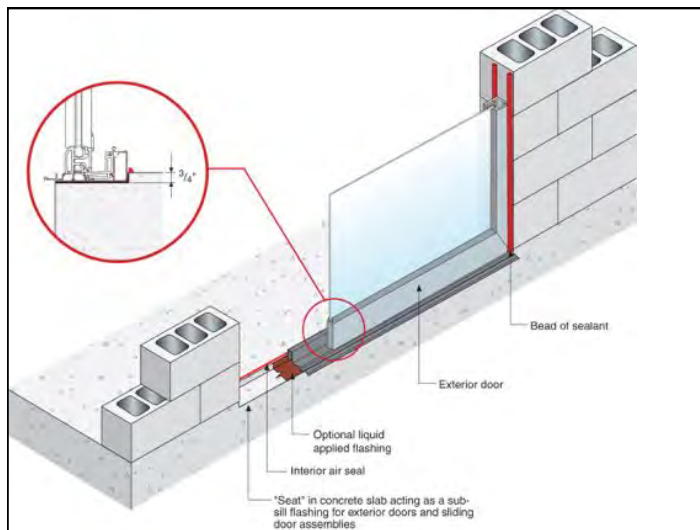
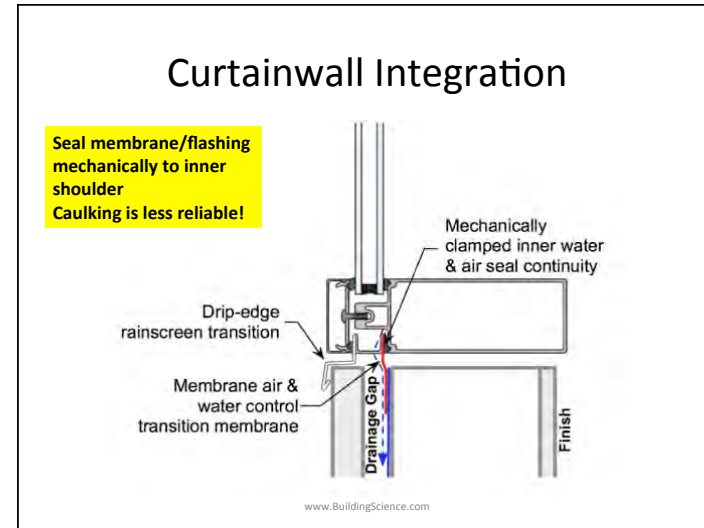
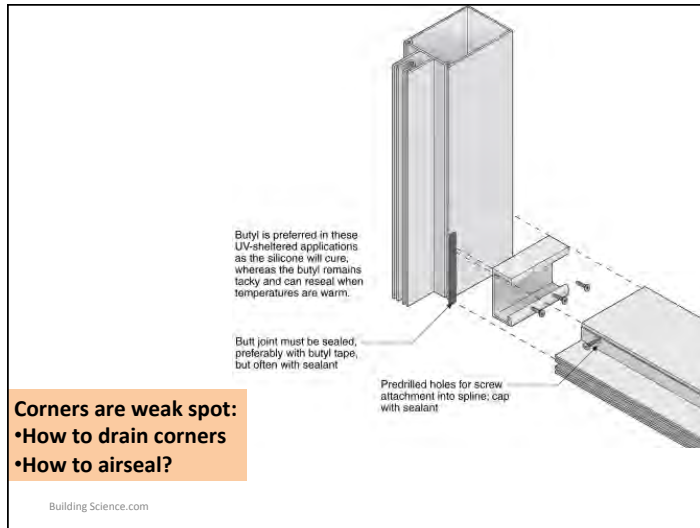

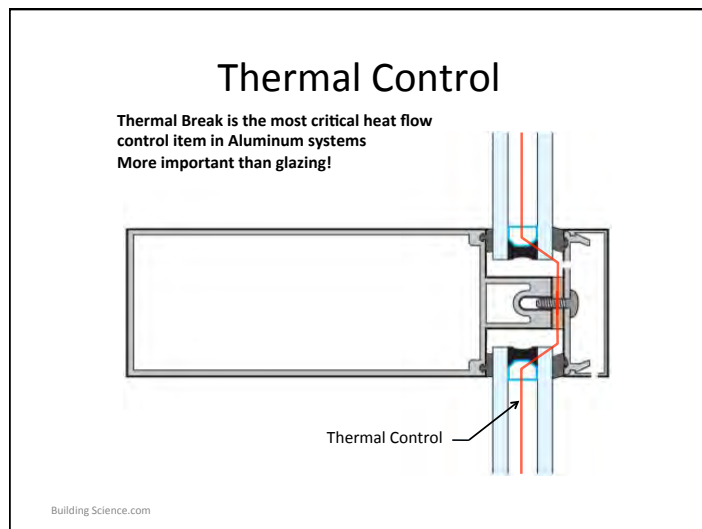
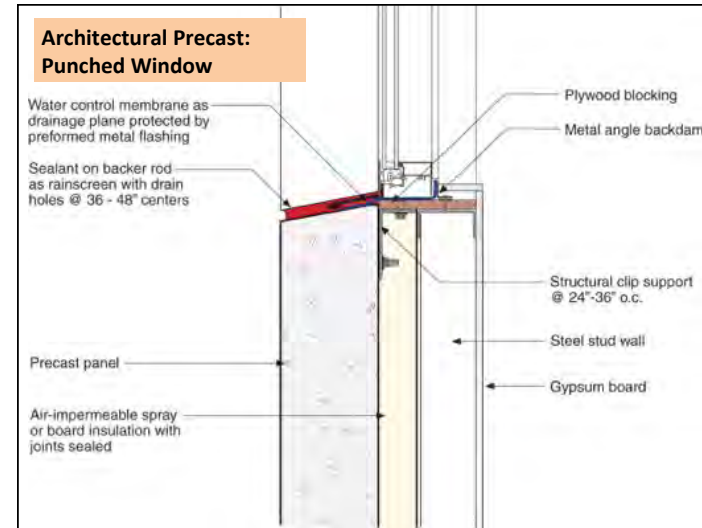
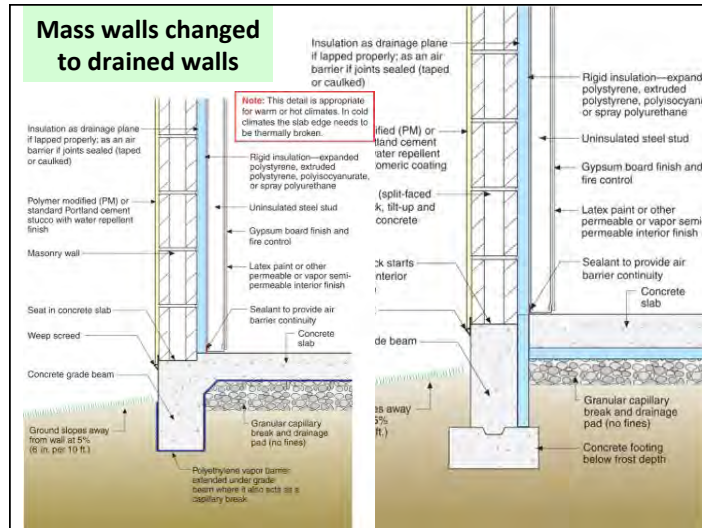

- ### Air-Water-Vapor
- Often thin layers
  - *Can be*
    1. Water control (vapor permeable, not airtight), **or**
    2. Air & water control (vapor permeable), **or**
    3. Air, water & vapor (vapor impermeable).
  - Examples
    - Building paper, untaped housewrap, sealed and supported housewrap, fluid applied, peel and stick
- www.BuildingScience.com



### Air-Water Control Layers

Sloped and complex surfaces demand very high performance



www.BuildingScience.com

### Fully-adhered air-water barrier

Vapor Permeable!



Self-adhered—no staples, nails and tears that allow air and moisture to pass through walls

www.BuildingScience.com

### Spray/Trowel Applied Air/water

- Semi-permeable



Building Science.com 99

### Closed-cell spray polyurethane foam: ccSPF

- Rain control
- Air Control
- Thermal Control
- Vapor Control





## Airflow control

- Airtightness critical for all climates
  - Control condensation (summer and winter) and energy waste
- Airflow Control Layer
  - Practically, an air barrier system
- Cant be TOO tight
  - But must provide ventilation

103/175

## Airtightness

- Materials not important, *system* is
- GSA and Army Corp requiring testing to tightness targets now
  - 0.40 and 0.25 cfm/sf@75 Pa respectively
- IECC/IRC likely to require soon
  - Measured at 50 Pa in houses

Building Science.com 104

### Air + Water Barrier

- Beware:
- Around windows
- Canopies
- Parapets



Find the air leak

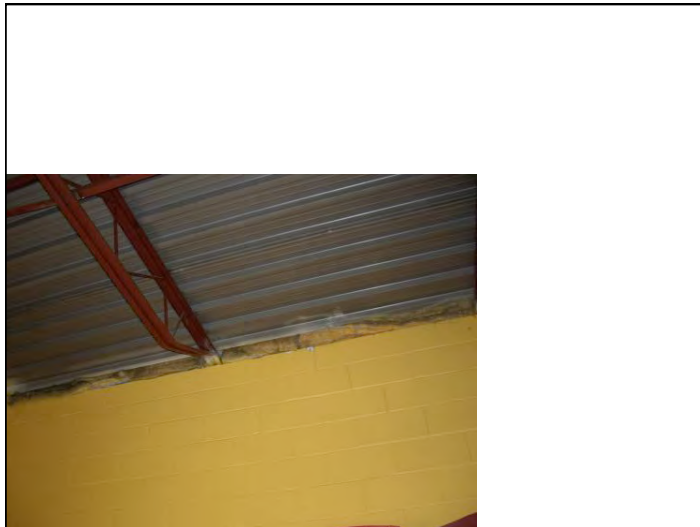

Tampa hotel, above bathroom ceiling

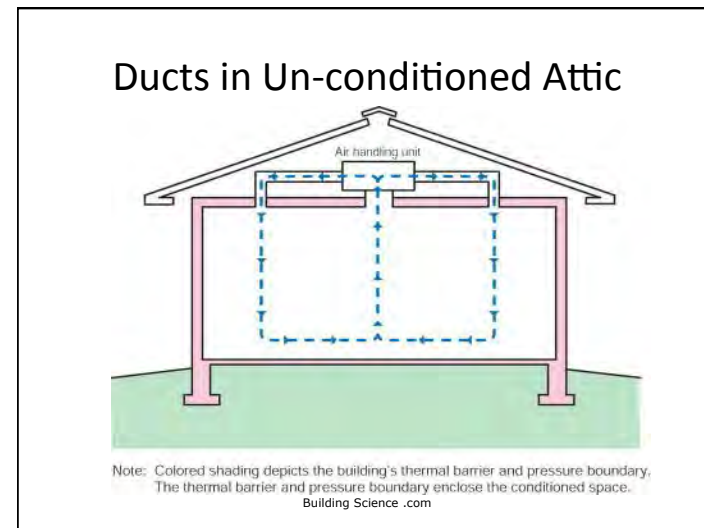
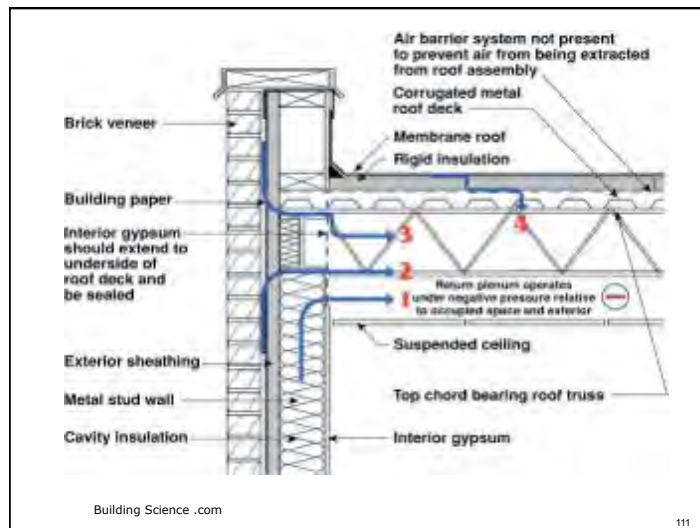
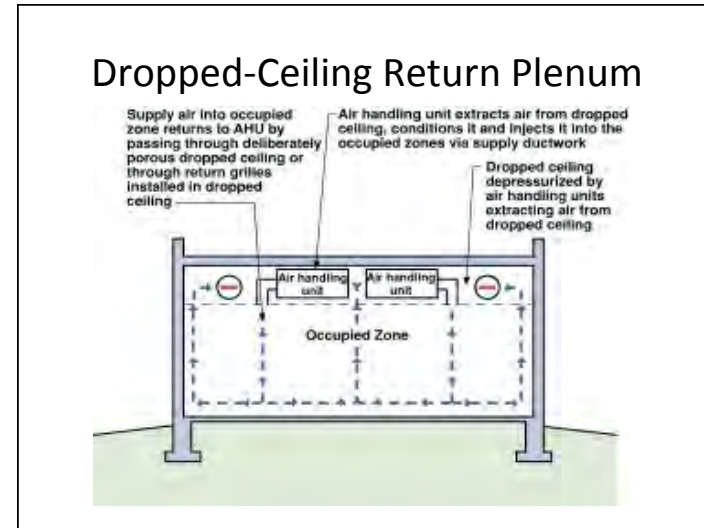
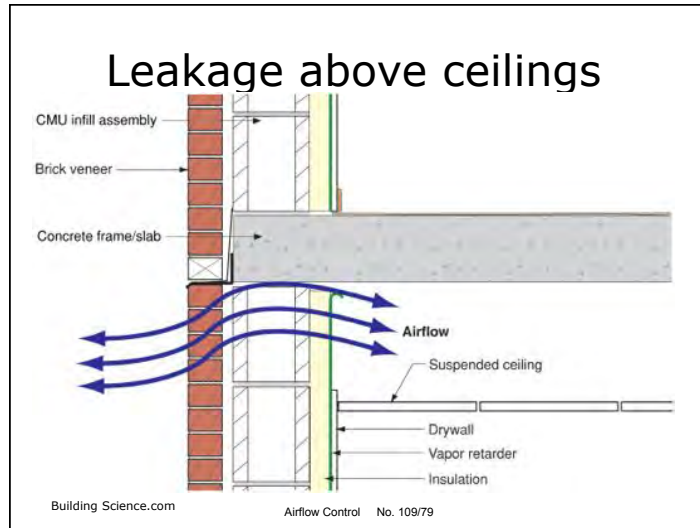

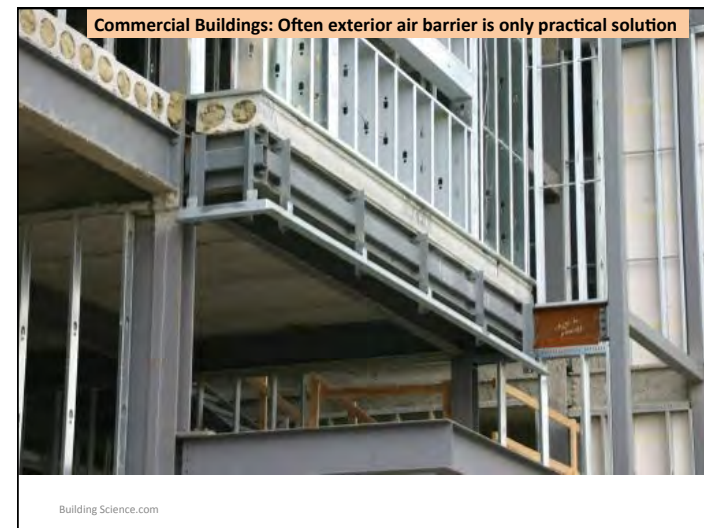
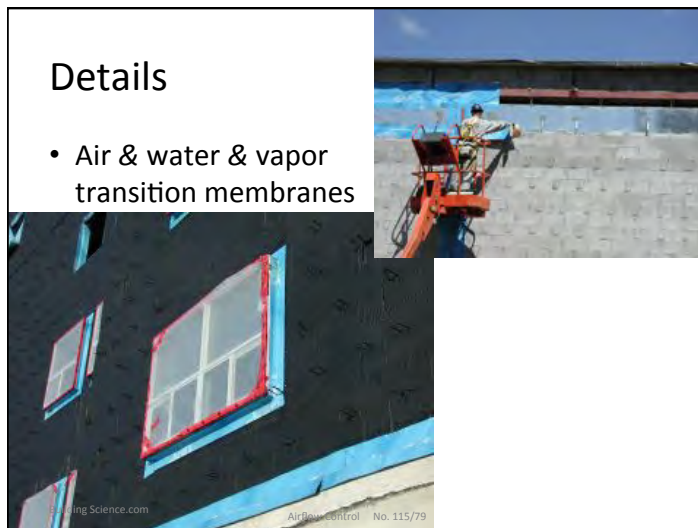
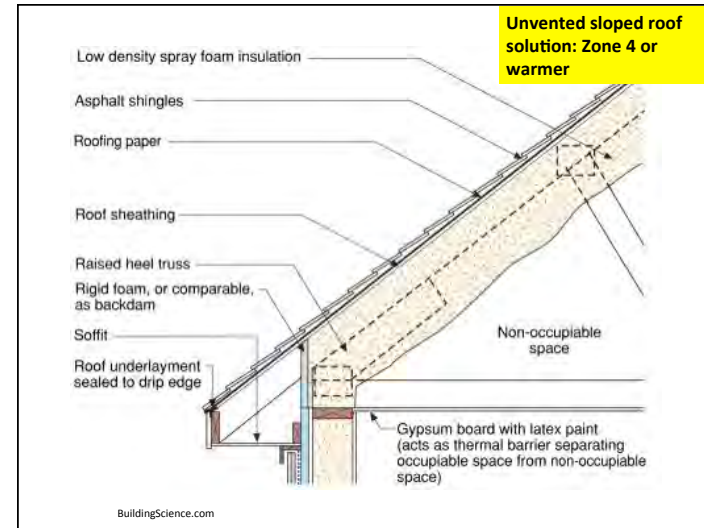
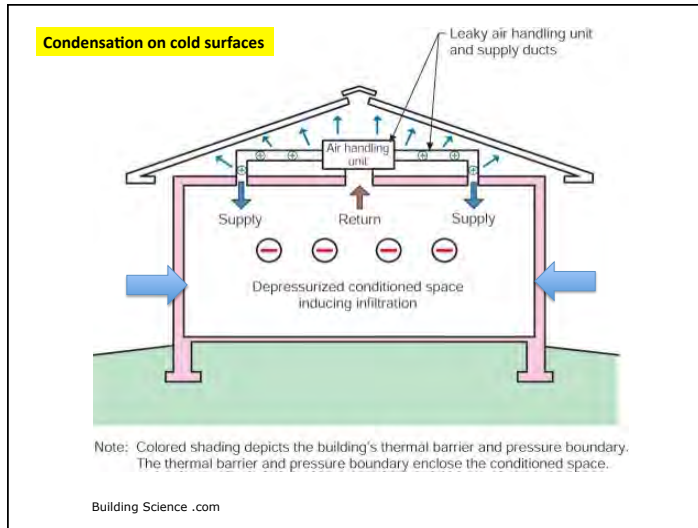

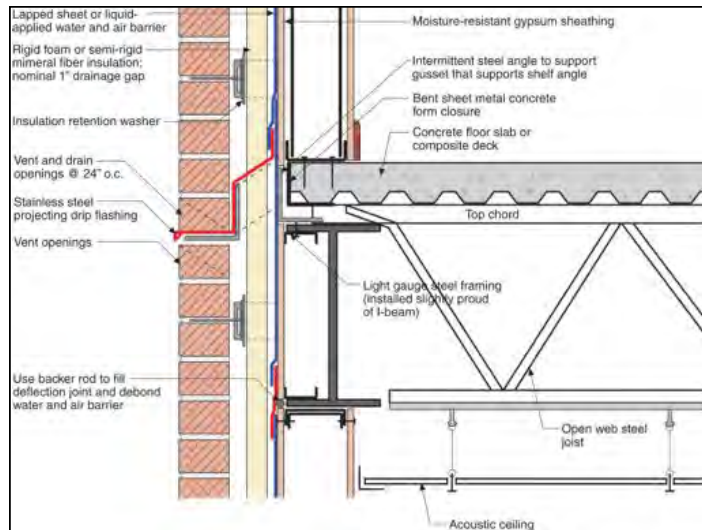

### 3. Thermal control

- Ensure Comfort
  - Avoid hot/cold interior surfaces
- Warms surfaces = durability
  - Avoids condensation in hot and cold weather
  - hence, a durability and health strategy
  - Keep structure warm and dry and stable
- Save Energy
  - Reduce heat flow

12-09-28

### Thermal Control

- Insulation (conduction)
  - Slows heat flow in and out
- Windows (conduction, radiation)
  - Slow heat flow in and out
  - Control solar gain : allow or reject?
- “cool” roofs
  - Reduce solar gain
- Radiant barriers

www.BuildingScience.com

## Solar Shading

- Reduce window area
- Provide shading (do analysis)
- Low-solar gain



## Insulation

- How much? Use much *more than normal practise*
- Comfort & condensation resistance:
  - **True** R5-10 is usually enough, but .....
- For energy / environment:
  - “As much as practical”, eg R10-R20
- “True” R-value is what matters
  - Control thermal bridging!
- Increased insulation should reduce HVAC capital as well as operating!

Building Science

## Thermal Insulation

Insulation	R-value/inch	k (W/mK)
Empty airspace 0.75”-1.5” (20-40 mm)	R2.0 - 2.75	0.36 –0.50 W/m <sup>2</sup> K
Empty airspace 3.5”-5.5” (90-140 mm)	R2.75	0.50 W/m <sup>2</sup> K
Batt (mineral fiber)	3.5-3.8	0.034 - 0.042
Extruded polystyrene (XPS)	5.0	0.029
Polysiocyanurate (PIC)	6.0-6.5	0.022 - 0.024
Expanded polystyrene (EPS)	3.6-4.2	0.034 - 0.040
Semi-rigid mineral fiber (MFI)	3.6-4.2	0.034 - 0.040
Spray fiberglass	3.7-4.0	0.034 - 0.038
Closed-cell spray foam (2 pcf) ccSPF	5.8-6.6	0.022 - 0.025
Open-cell spray foam (0.5 pcf) ocSPF	3.6	0.040
Aerogel	8-12	0.012-0.018
Vacuum Insulated Panels (VIP)	20-35	0.004-0.008

## Thermal Continuity / Thermal Bridges

- Some short circuiting is normally tolerated.
- High-performance walls tolerate few bridges
- Major offenders / weak spots
  - Penetrating slabs (<R1)
  - Steel studs (<<R1)
  - Windows (R2-R3)
- **Product of Area and U-value** defines significance to energy and condensation

www.BuildingScience.com

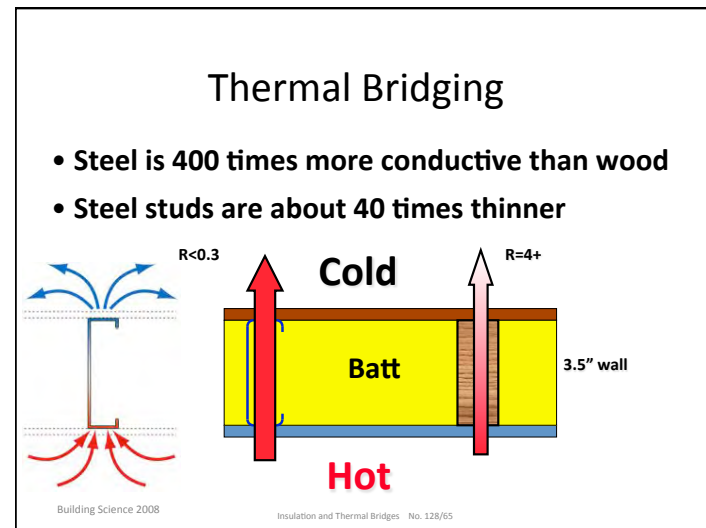



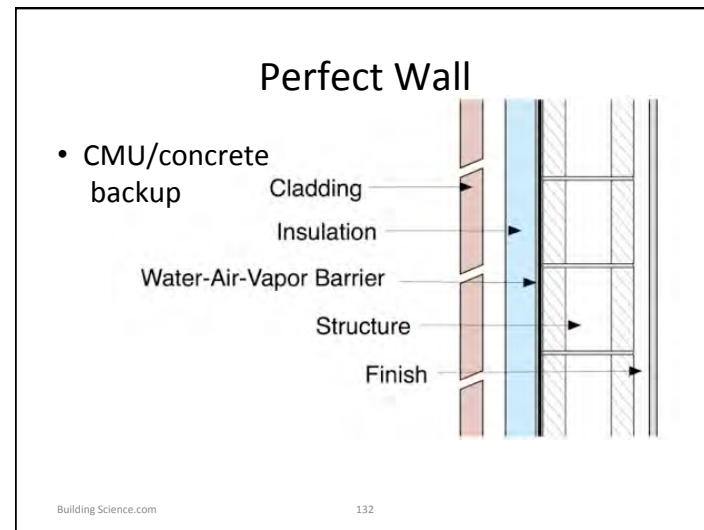
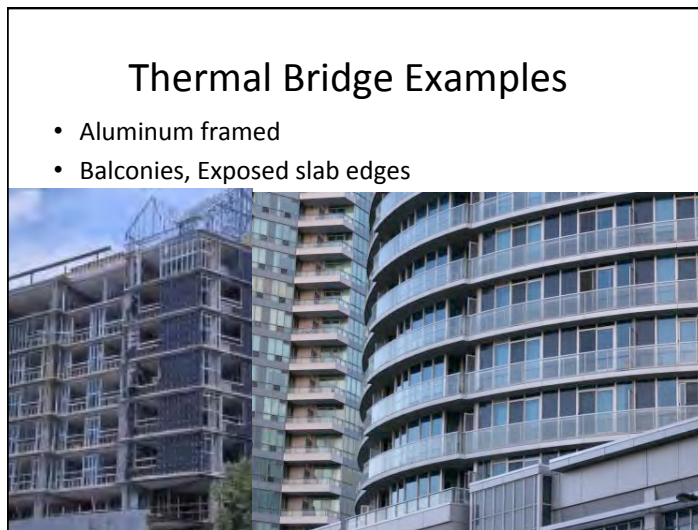
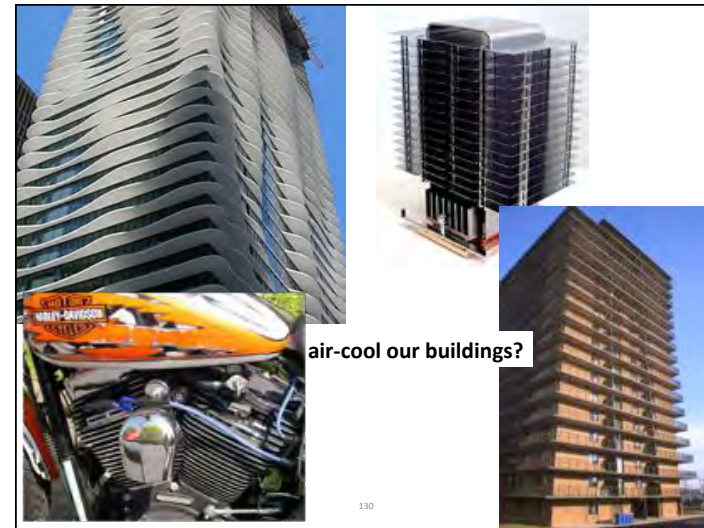
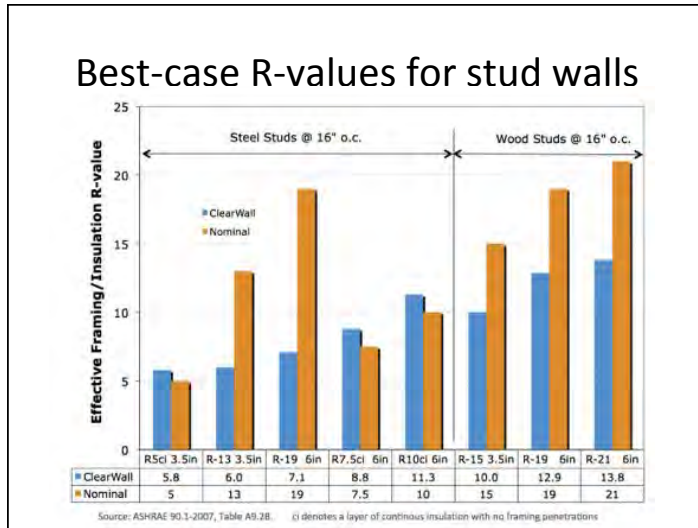

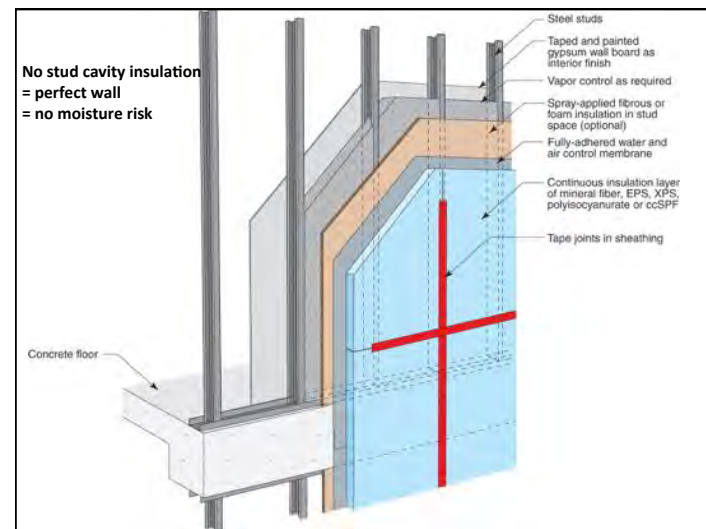
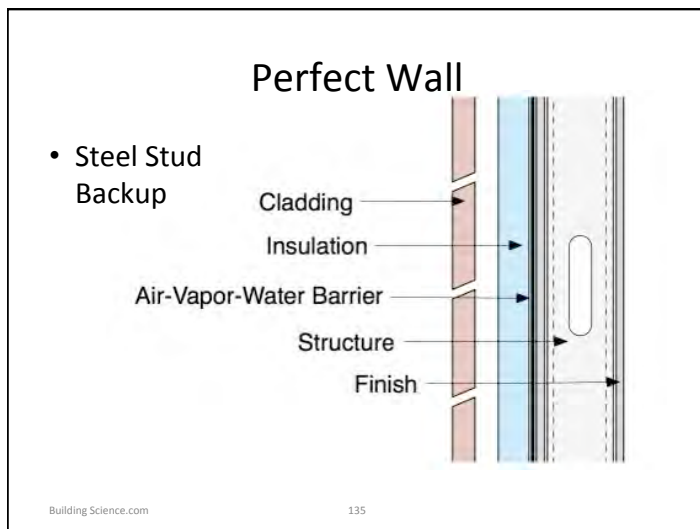
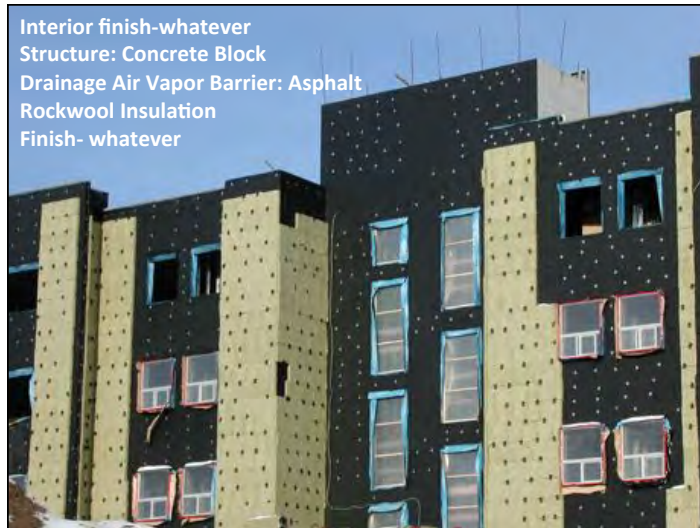

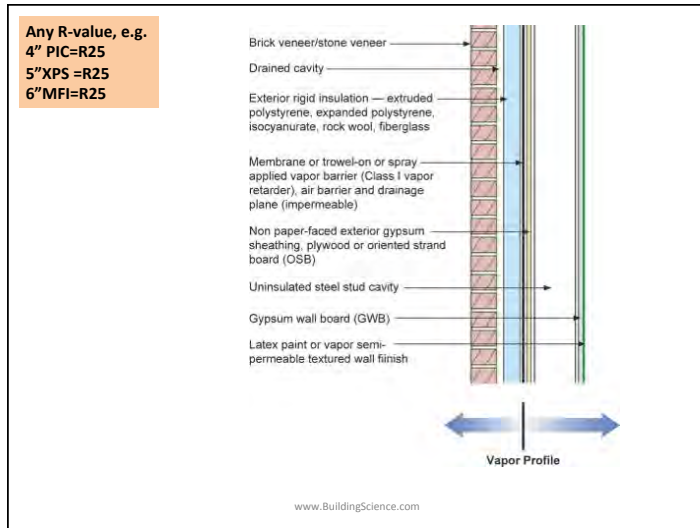

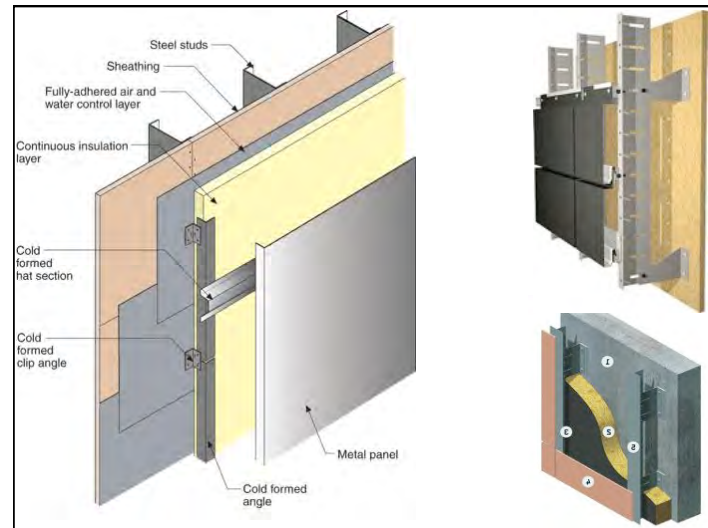

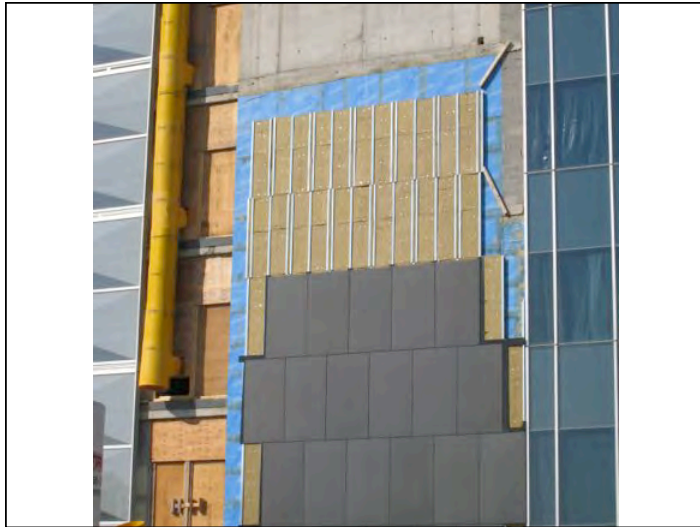

University of Hartford

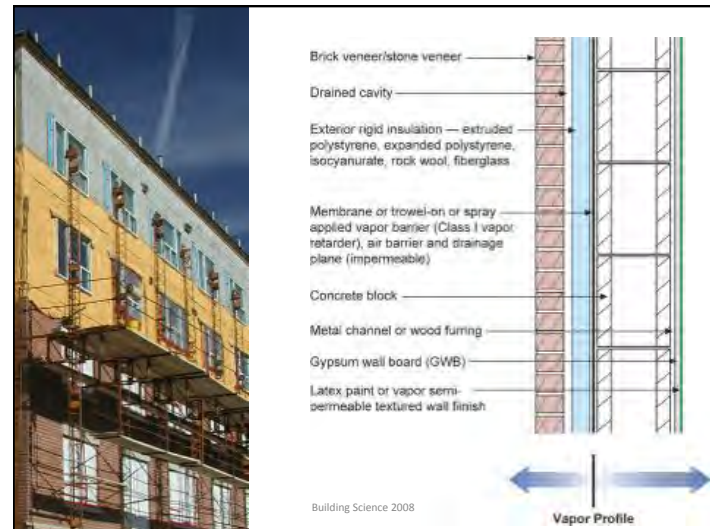

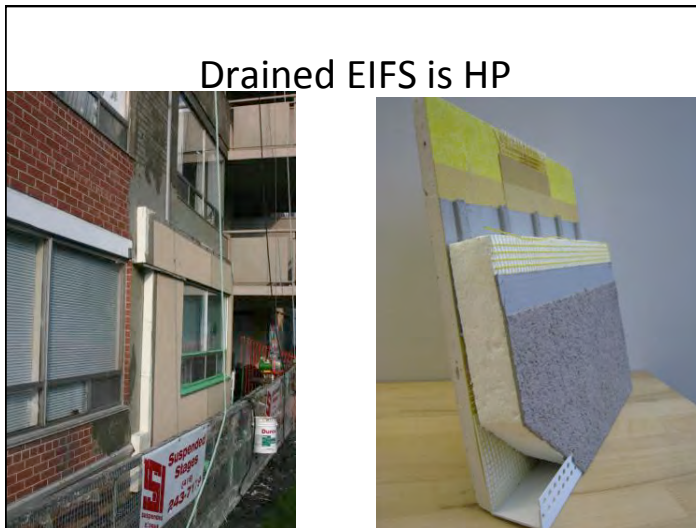
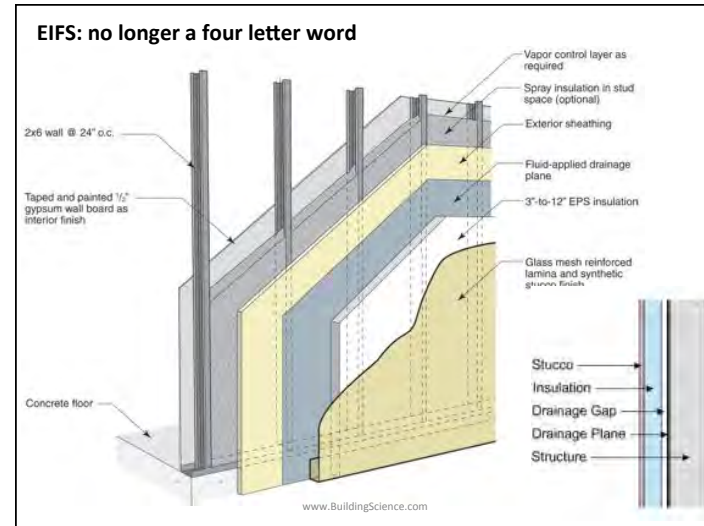

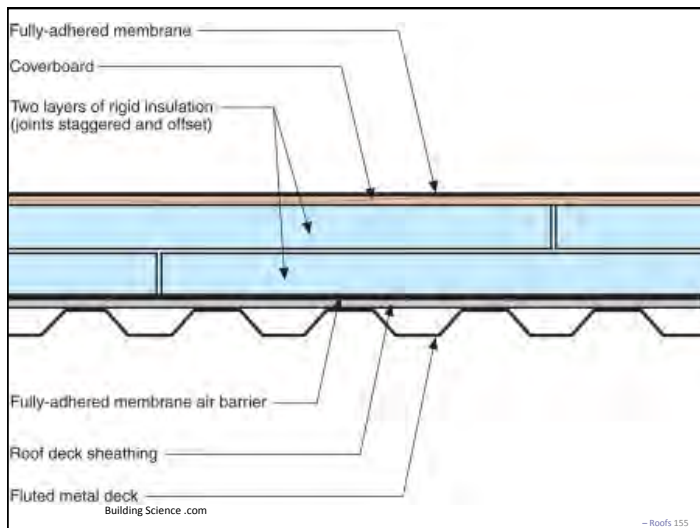
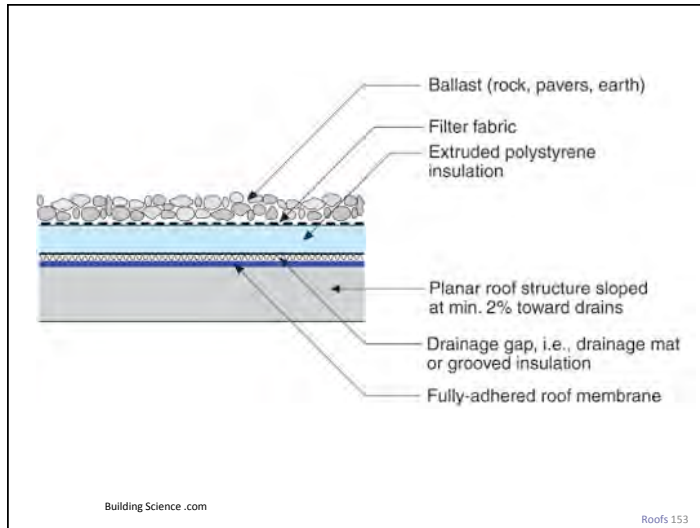

### Best UV Protection: rocks

- But, you need to hold down to resist wind
- Light color stones = reflective roof performance

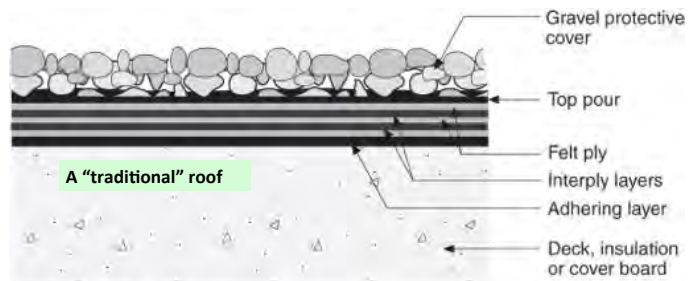

From Baker, M.; Roofs, 1980



### White roofs

- Lower heat gain: great!
- Reduce stress on exposed roof membranes
- **But:** Reduces drying out of roof
- **Thus:** Require better moisture control!
  - Air barrier
  - Construction moisture



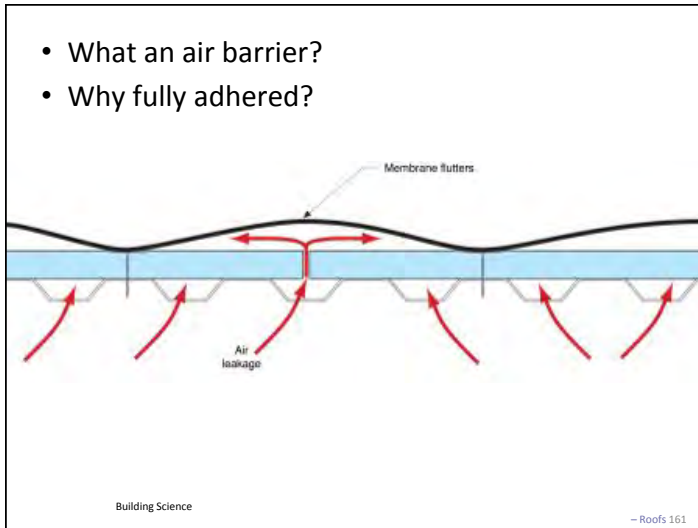

### Low-level air barriers

- Roof membranes can be air barriers
- In practise, a deck level air barrier is more reliable, easier to control
  - Other benefits include secondary roof during construction and re-roofing

Building Science.com  
Roofs 162

### Sloped roofs

- Basic Physics are the same
- Slopes allows non-waterproof materials to be lapped “shingle fashion”
- Air – vapor impermeable insulation needed OR ventilation of the sheathing
- Air leaky roofs require more ventilation

Building Science  
— Roofs 163

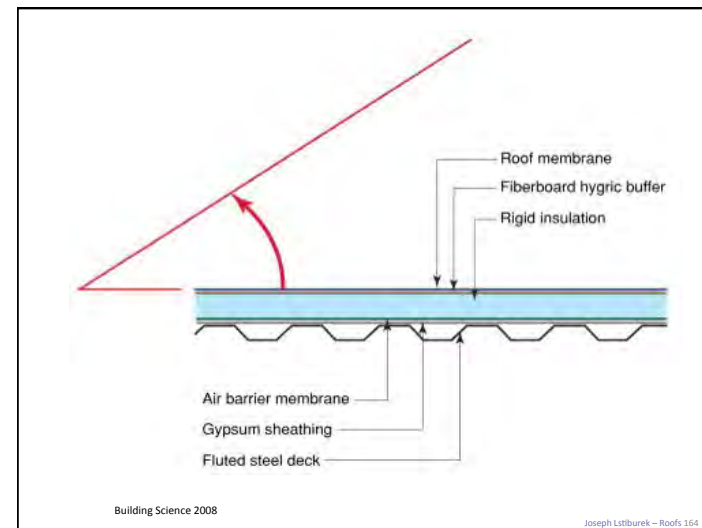

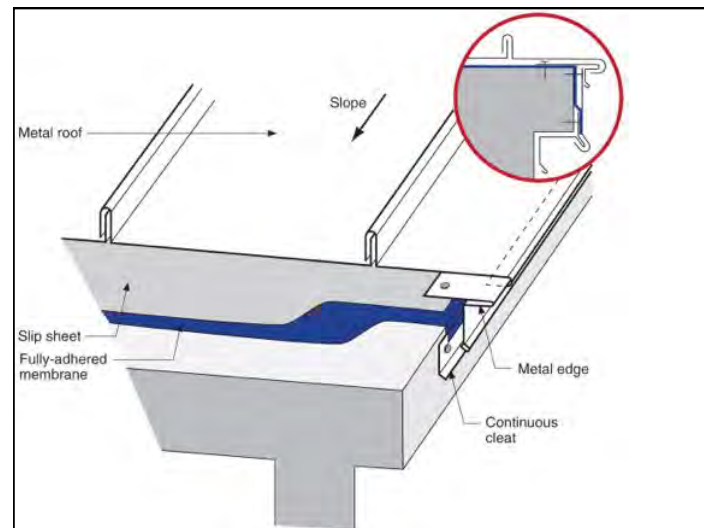
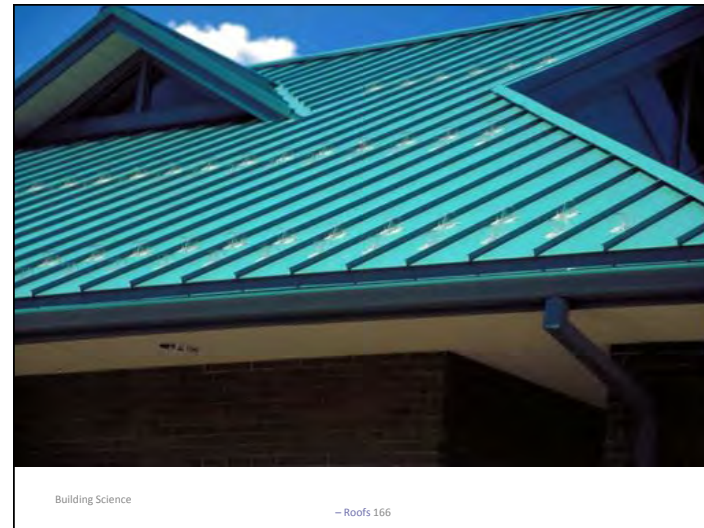
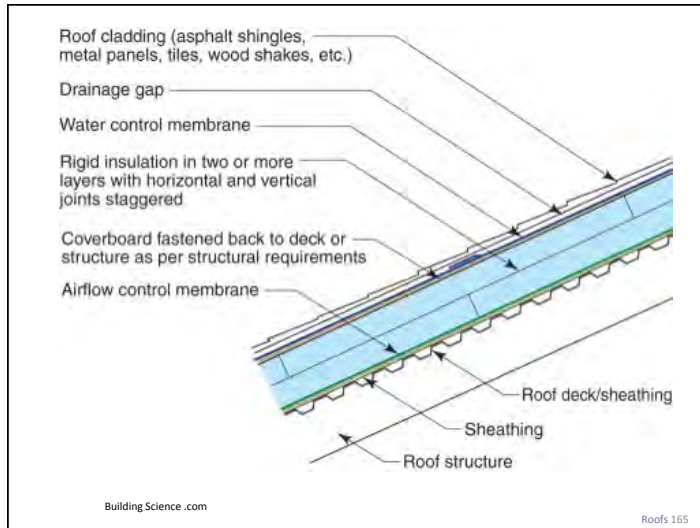



## Conclusions

- Continuous drainage and rain control layer
- Continuous air control layer (air barrier)
- Continuous thermal control layer
  - Limit the thermal bridges

## Good Mechanicals

The other half of the pie

## Functions

Five Critical functions are needed

- Ventilation
  - “fresh air”
  - Dilute / flush pollutants
- Heating
- Cooling
- Humidity Control
- Air filtration / pollutant Removal
  - Remove particles from inside and outside air
  - Remove pollutants in special systems

12-09-28

172

### What do you need to deliver?

Type	Temperature	Humidity	Pressure	Examples
I a	●			Heated house, warehouse
I b	●	○		Heating and normal A/C
I c	●		○	Heating + exhaust fans
I d	●	○	○	Heating+ A/C + exhaust fans
II a	●	●		Museum, fruit storage
II b	●	●	○	Pressurized + controlled
III	●	●	●	Special labs, chip fabrication
IV	●		●	Dust controlled manufacturing
V		●	●	
VI			●	

Note: ● Directly controlled ○ - Incidental Implicit

All require metered deliver of fresh air, and some exhaust of polluted air

### Common Air-based Systems

- CAV systems
  - high energy consumers but provide outdoor air
- VAV
  - decent energy performance, but rarely supply desired ventilation (fresh) air rates
- DOAS: Dedicated Outdoor Air Systems
  - provide Ventilation (+ almost always dehumidification) only
  - separate terminal equipment does heating and cooling
  - Highest performance, easy to design & fix

12-09-28

174

### Constant Air Volume

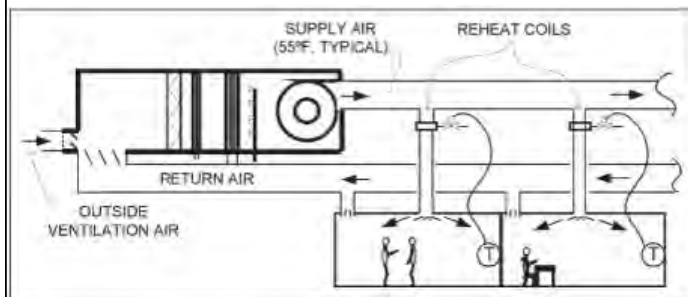

Great RH & T control (Dewpoint of 55 all the time)  
 Terrible energy performance (reheating almost all the air, all the time)  
 Often no designed exhaust air: "pressurize" building

12-09-28

175

### Variable Air Volume

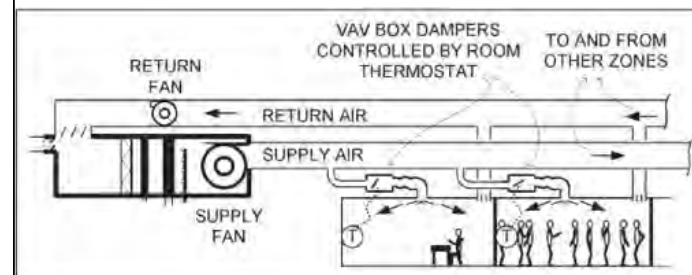

Poor IAQ: ventilation controlled by thermostat  
 Poor/no RH control: depends on cooling coil operation  
 Either good energy performance /poor RH, or good RH / poor energy  
 Often no designed exhaust air: "pressurize" building

12-09-28

176

## VAV: Fixing How it works

- Pre-treat all outdoor air to reduce humidity
  - Target leaving air dewpoint of <50F
  - Cannot use “cooling” only, need dehumidification
- Ventilation air still is uncertain
  - Thermostat controls ventilation!
    - Require reheating to avoid cold rooms at min. flow
  - In multi-zone system, one zone’s ventilation needs are different than an others’
    - Hence, either over-ventilation or under-ventilate

## Designer’s Question

- How is indoor humidity controlled when it is 65-80F outdoors and raining (100%RH)?
  - Sensible load is very low (lights+people)
  - Latent load high (ventilation + people)
  - AC does not run, or does not run much
- Answer usually is “not”
  - Reheat is energy intensive but works
  - ERVs reduce humidity load, they don’t eliminate it

## DOAS

- Dedicated Outdoor Supply
  - Supplies all required dry air and fresh air
- All ventilation air can be pretreated
  - Air should be dried to <50F Dewpoint
  - Supply of dry air to each space controlled *independent of thermostat*
- Key is to decouple humidity control/ventilation from temperature control

## Energy recovery ventilation

- Reduces equipment peak capacity (saves capital \$)
- Reduces load on heating/cooling/dehumidification (saves energy/operating \$)
- Usually makes sense for any large mechanical ventilation flow

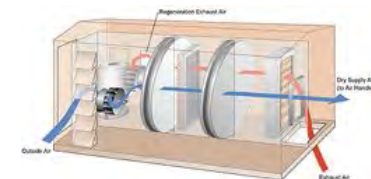

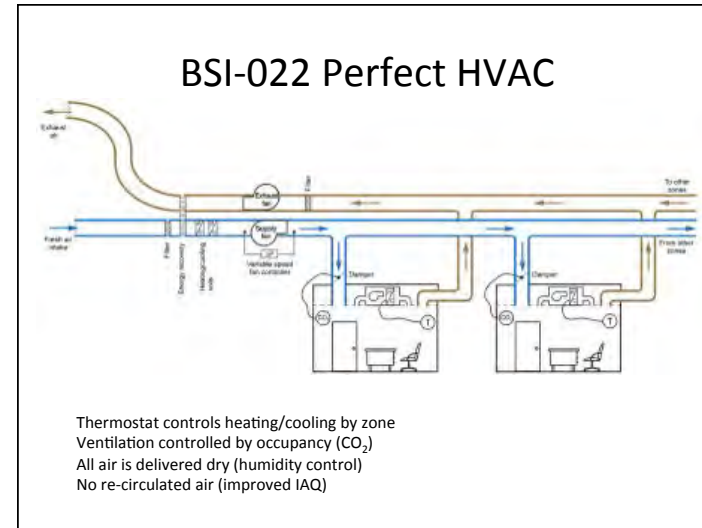
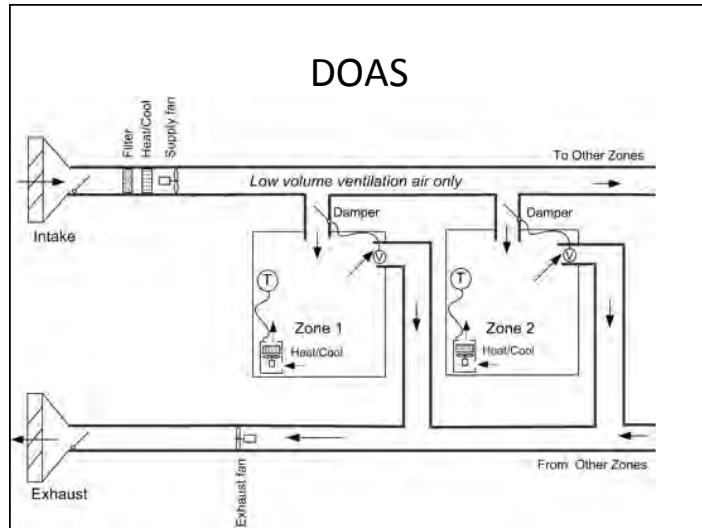

### Conclusions

- Key to good mechanicals is to separate ventilation from heating/cooling
- Consider humidity control in climates where it is needed

