

Joseph Lstiburek, Ph.D., P.Eng, ASHRAE Fellow

Building Science

Adventures In Building Science

presented by www.buildingscience.com

Definition of a Problem

People
Pollutant (hot, wet, UV, ozone)
Path
Pressure

Building Science Corporation

Joseph Lstiburek 2

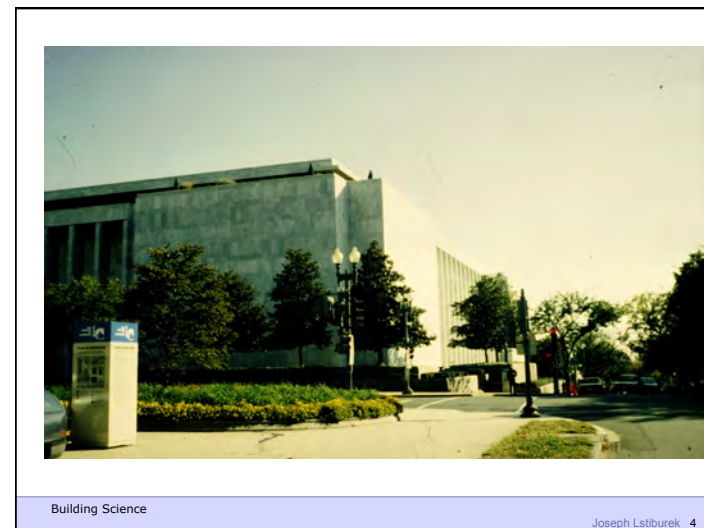
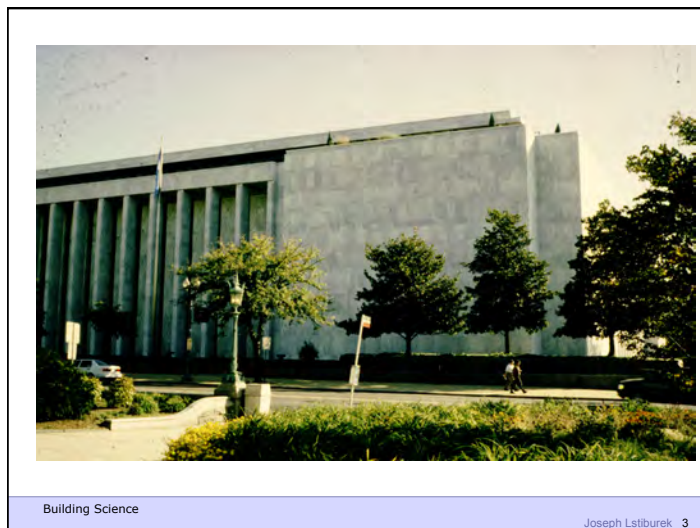

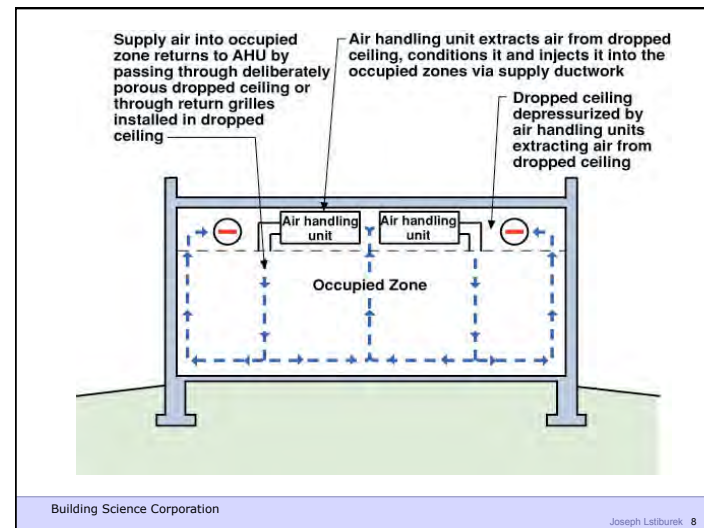
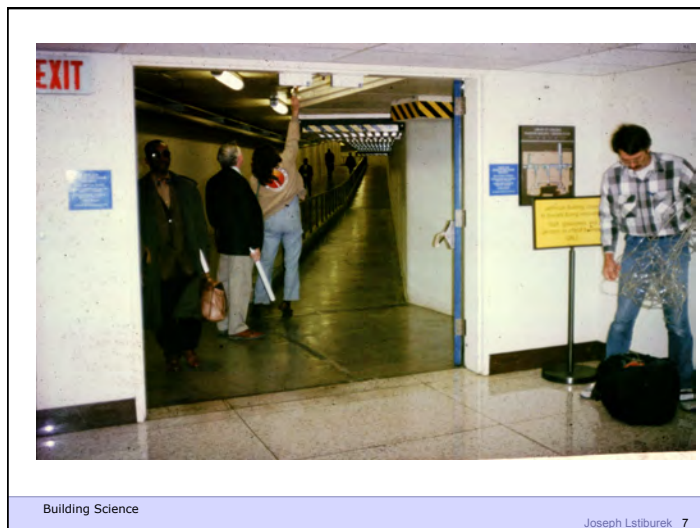
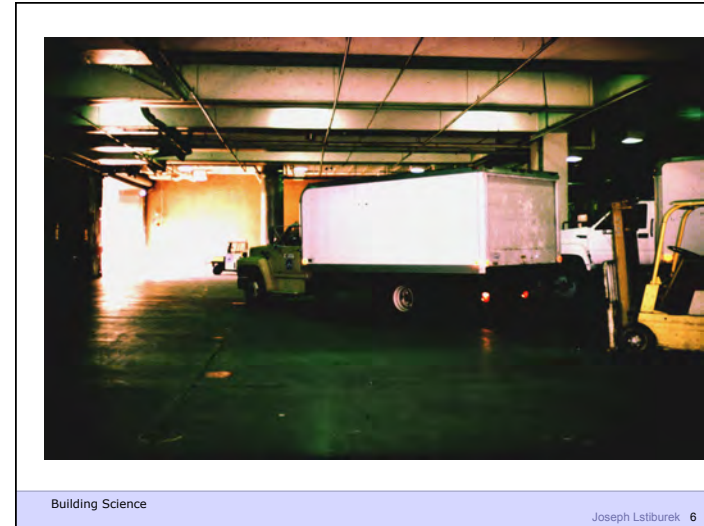

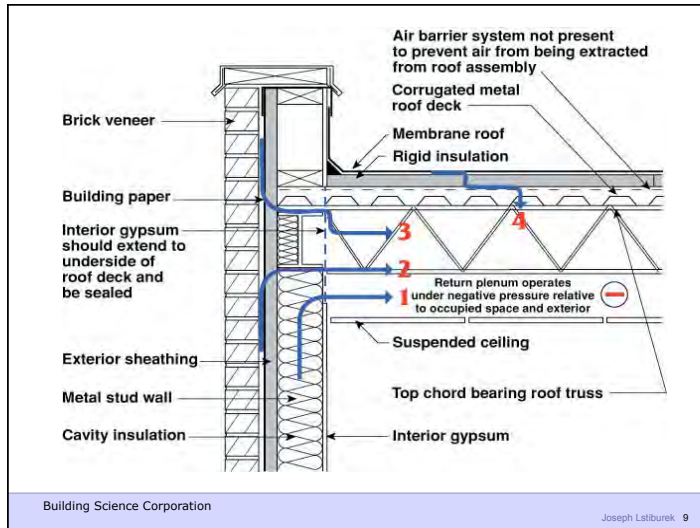

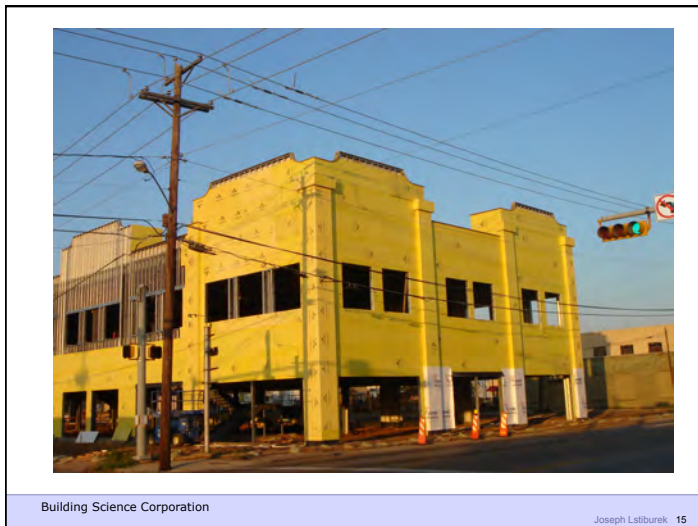
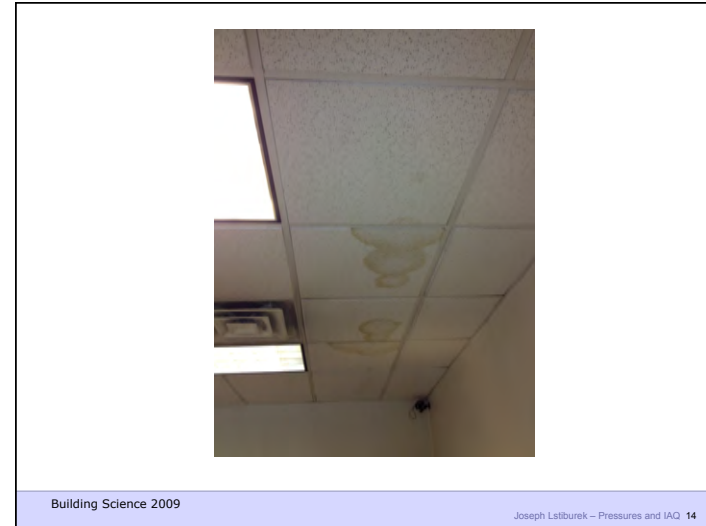

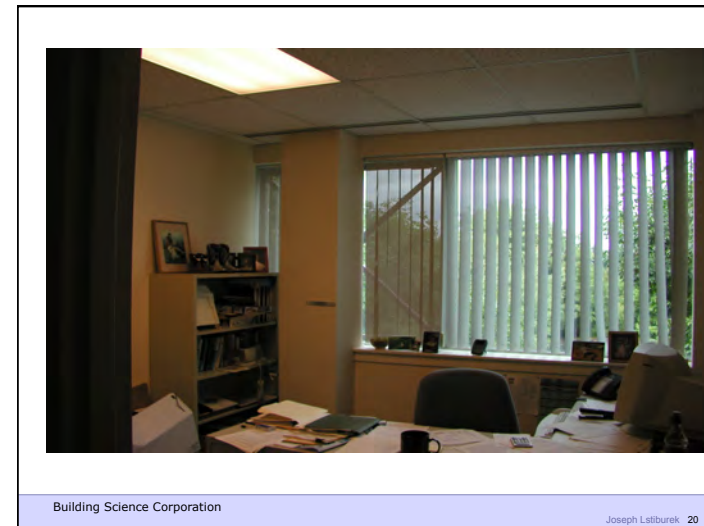
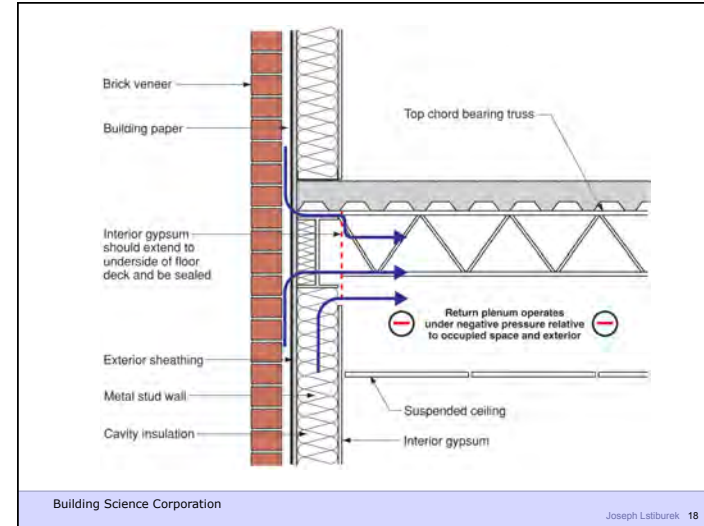
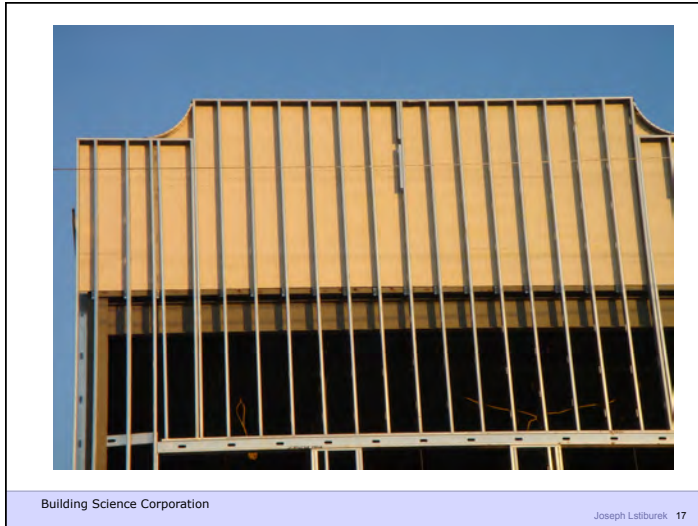

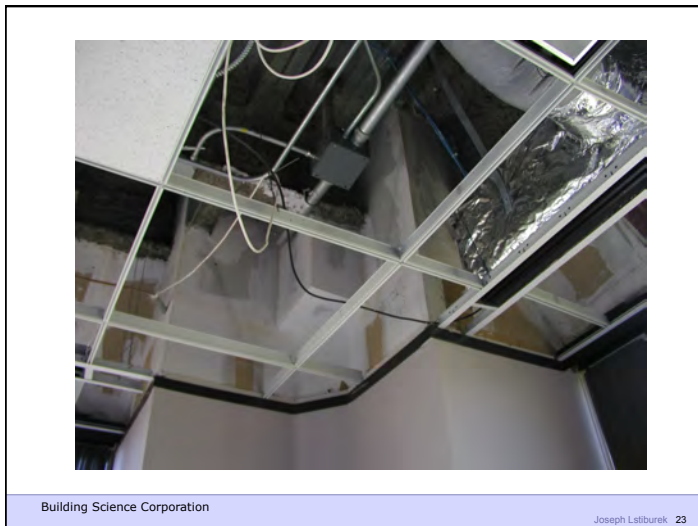
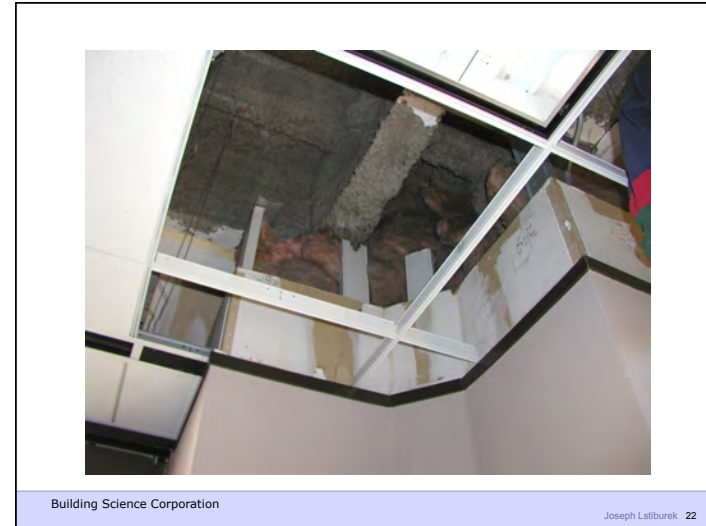



Building Science Corporation

Joseph Lstiburek 25

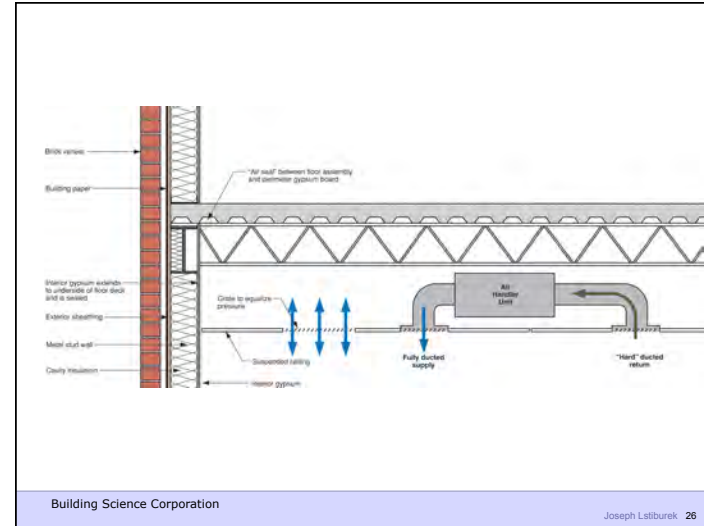

Building Science Corporation

Joseph Lstiburek 26

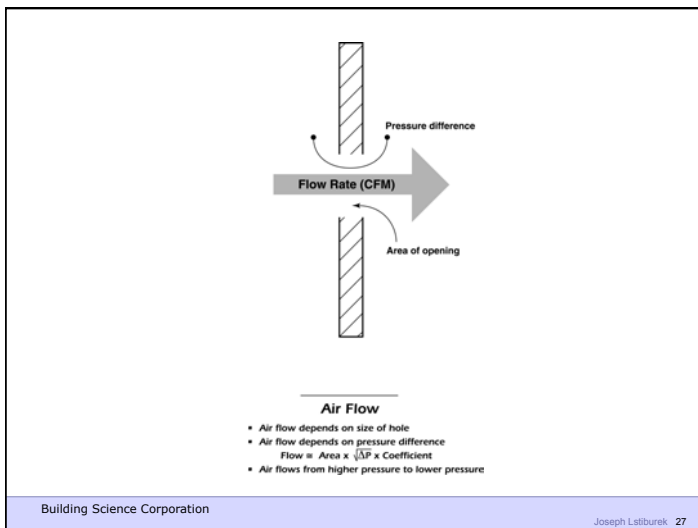

Building Science Corporation

Joseph Lstiburek 27

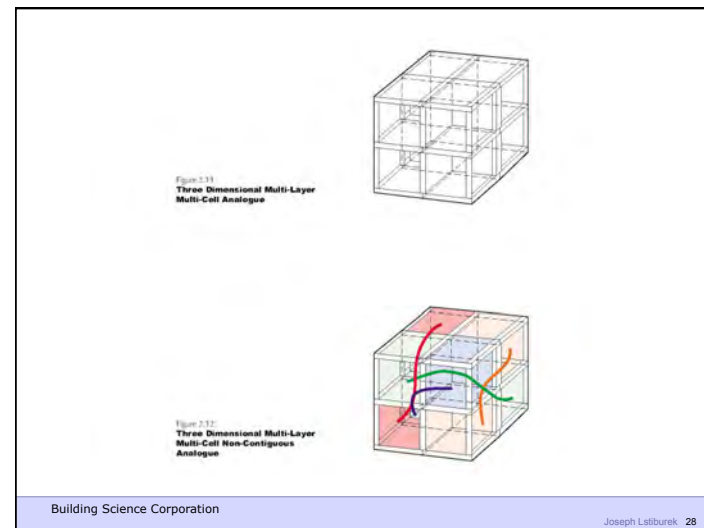

Building Science Corporation

Joseph Lstiburek 28

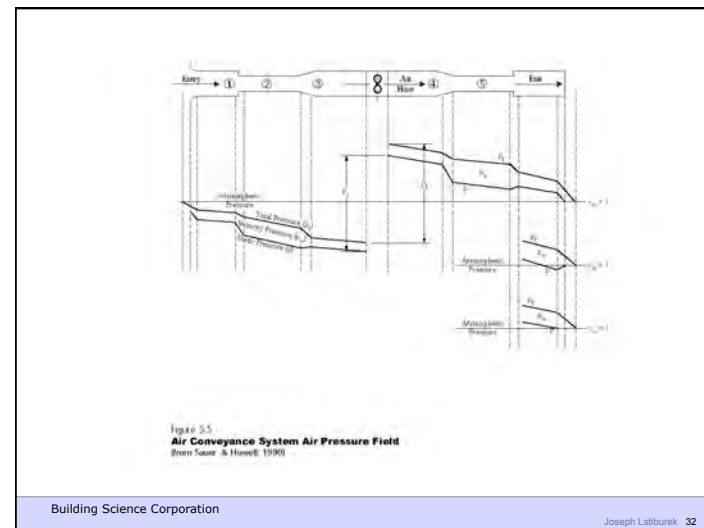
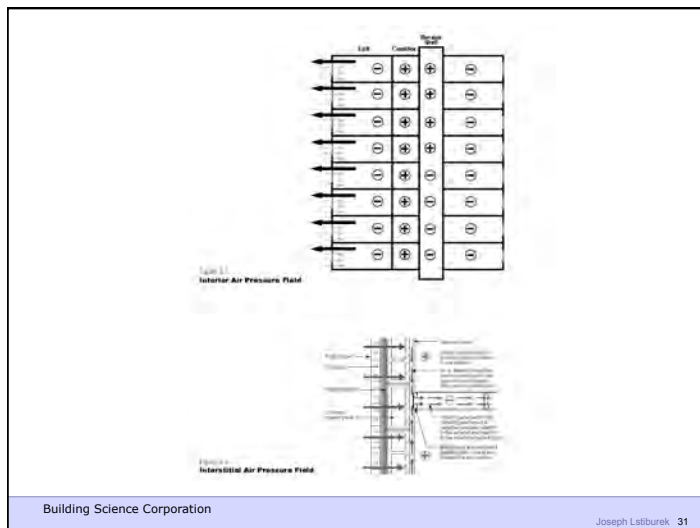
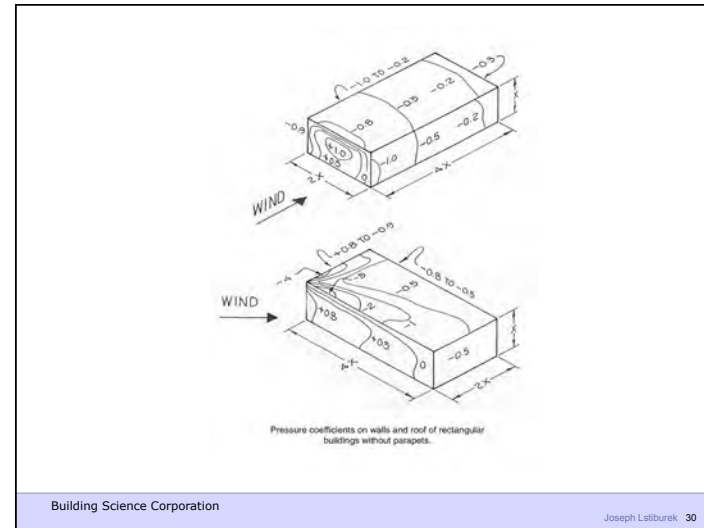
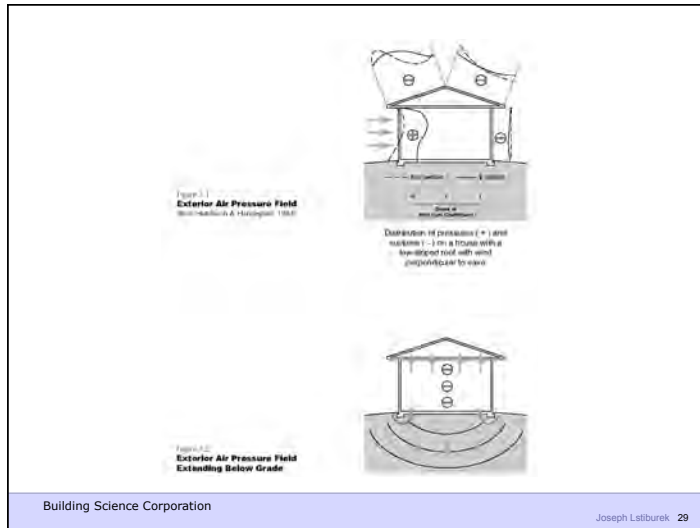



Building Science Corporation

Joseph Lstiburek 33

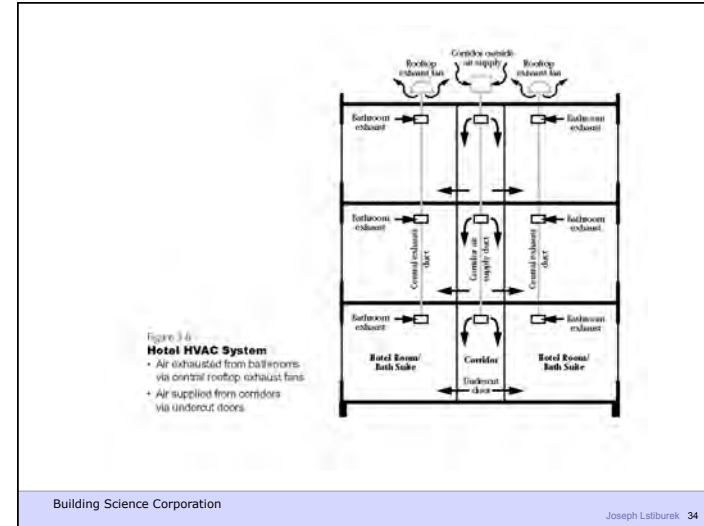

Building Science Corporation

Joseph Lstiburek 34

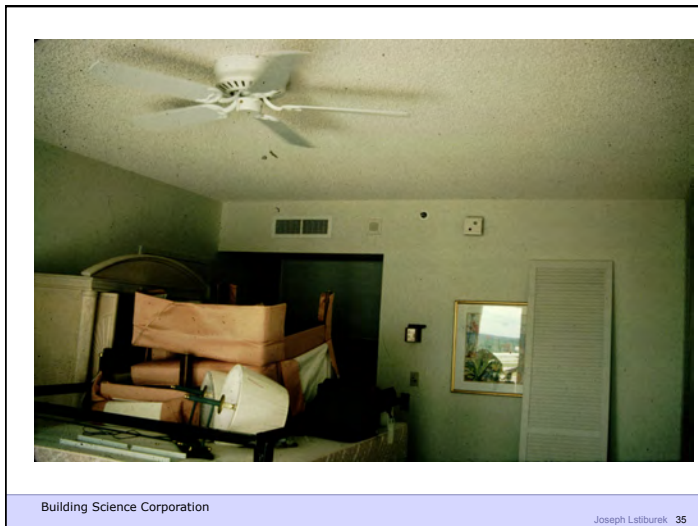

Building Science Corporation

Joseph Lstiburek 35

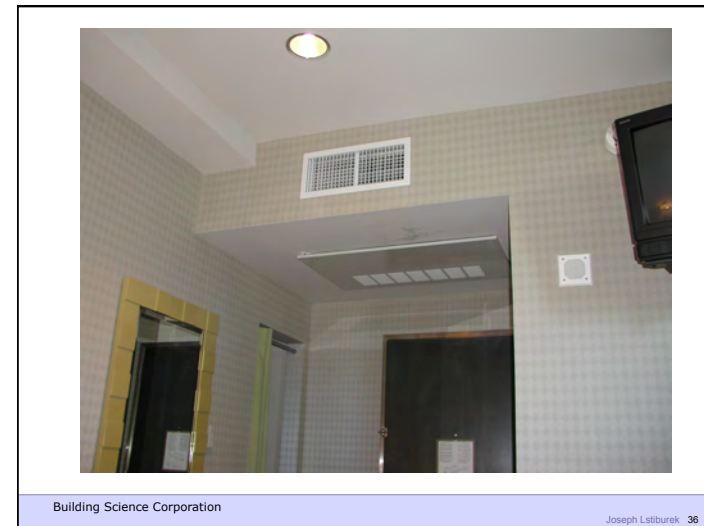

Building Science Corporation

Joseph Lstiburek 36

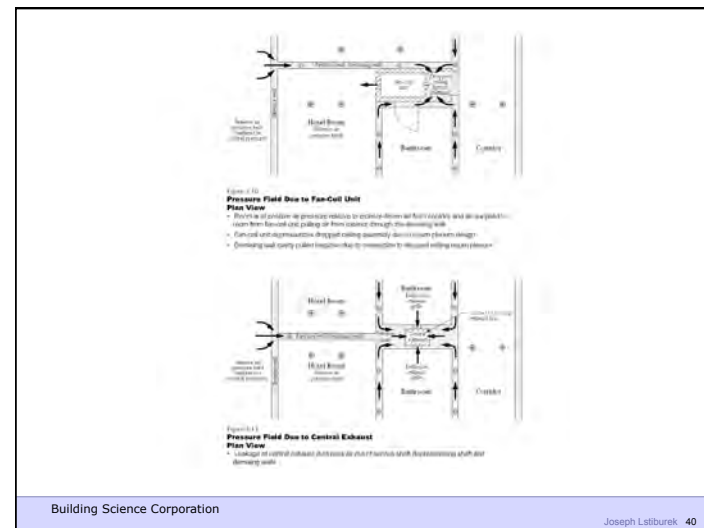
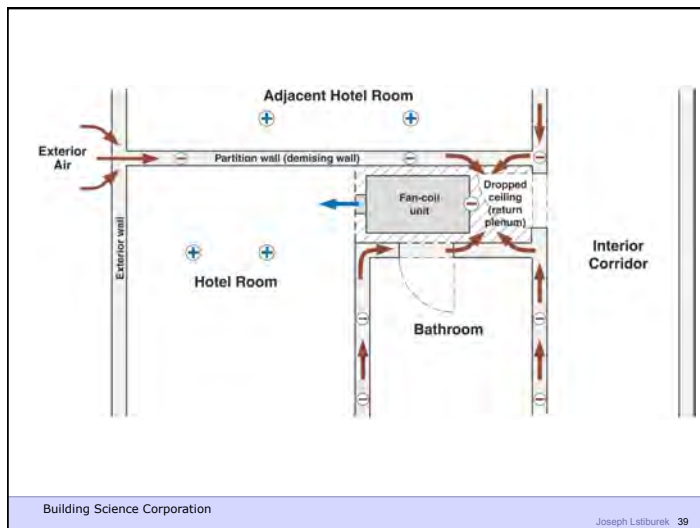
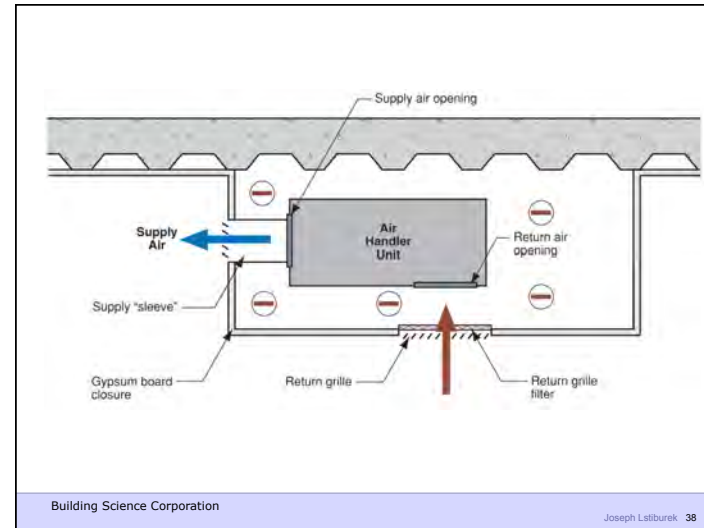
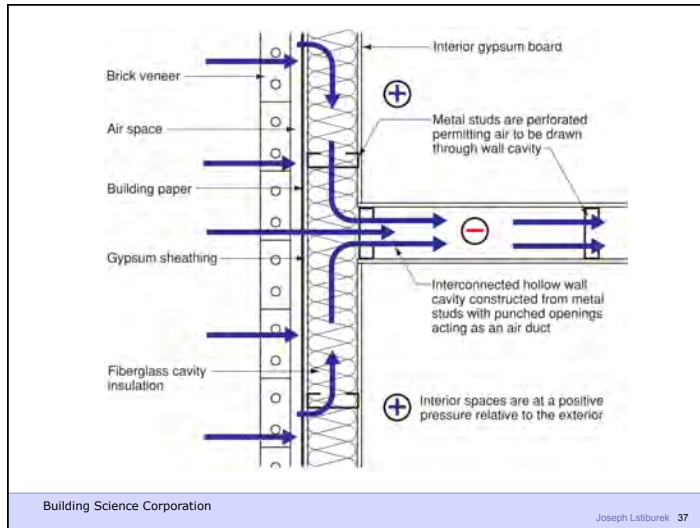

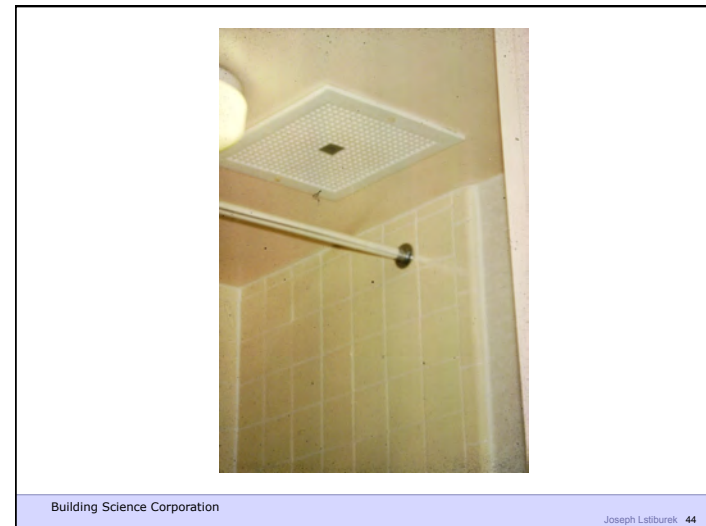
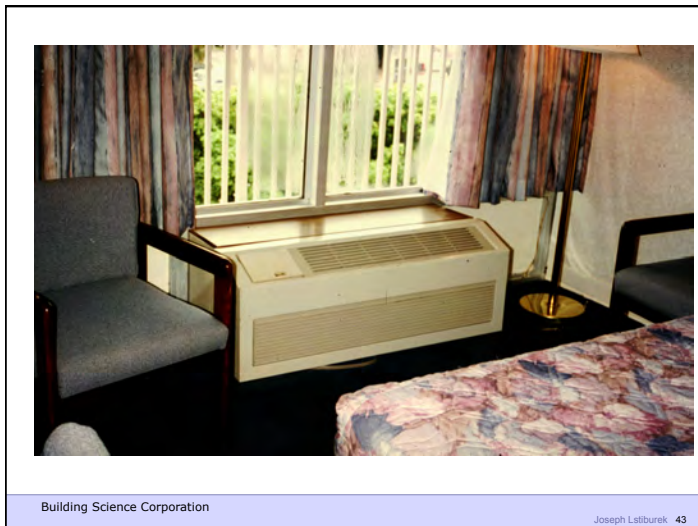

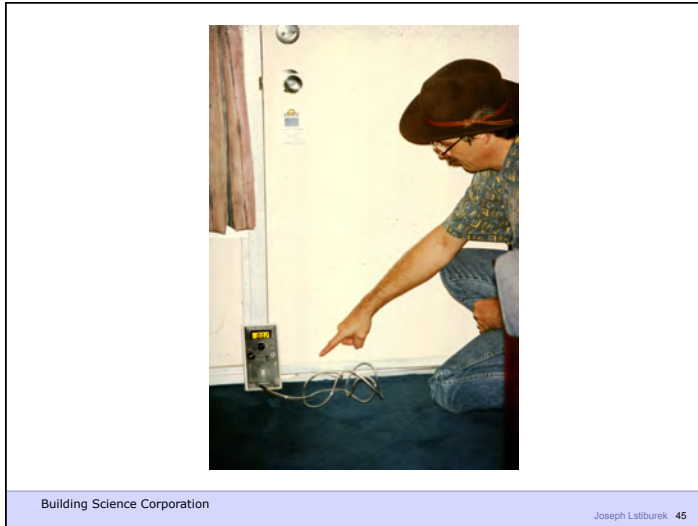

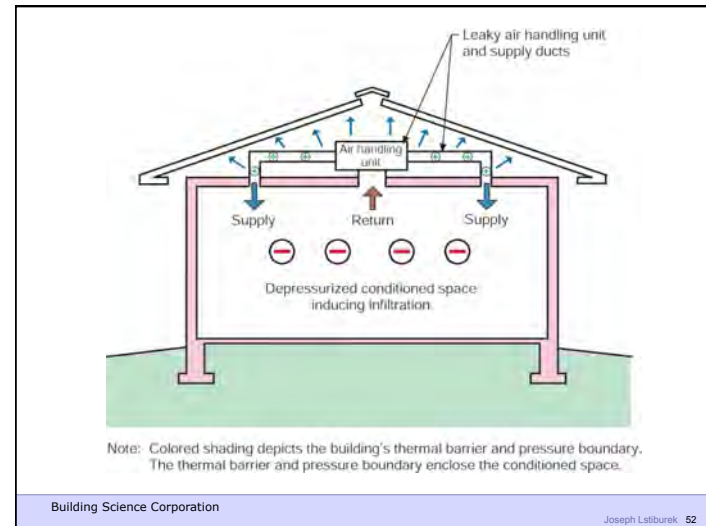

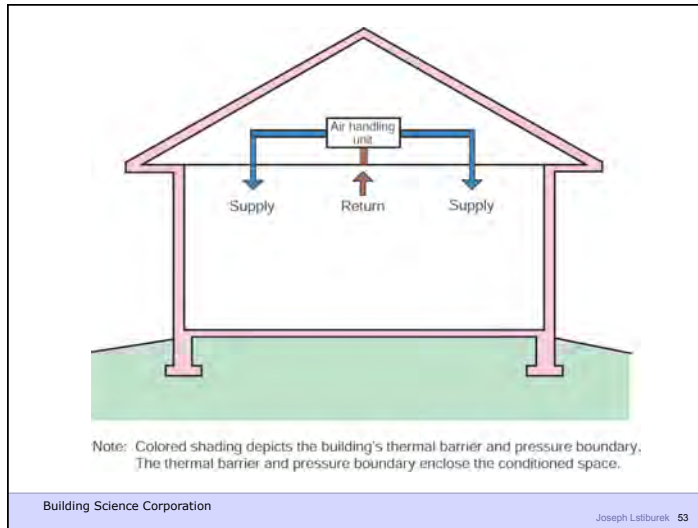

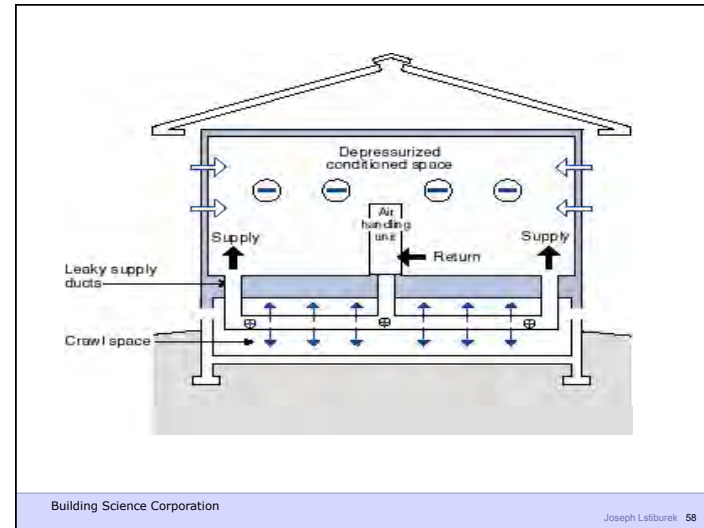
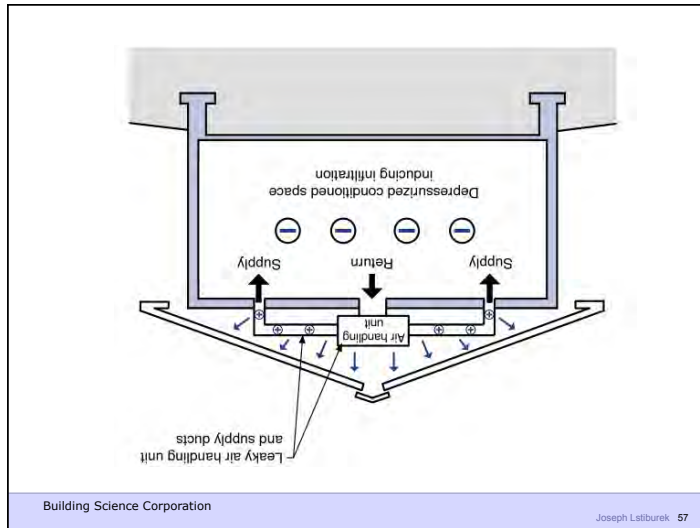

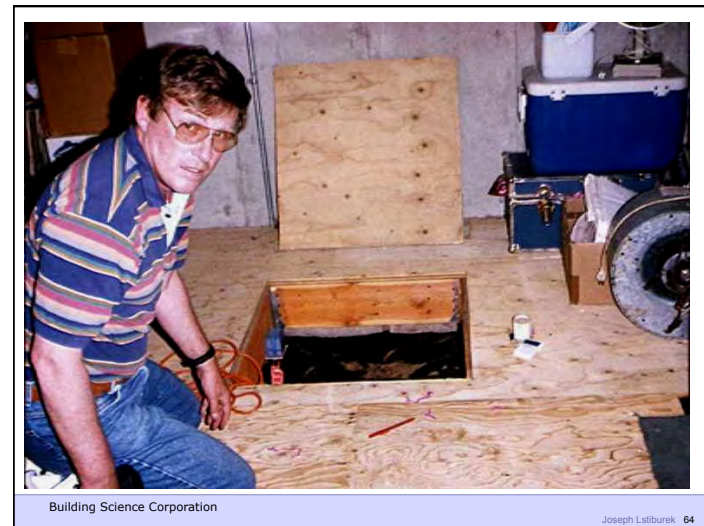
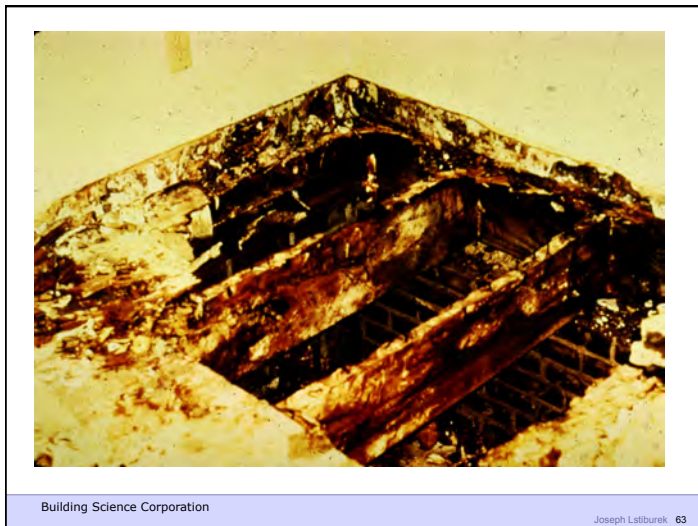
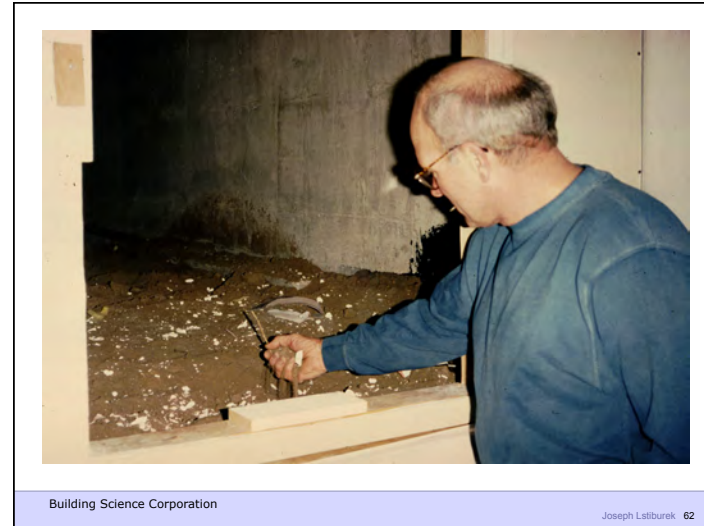

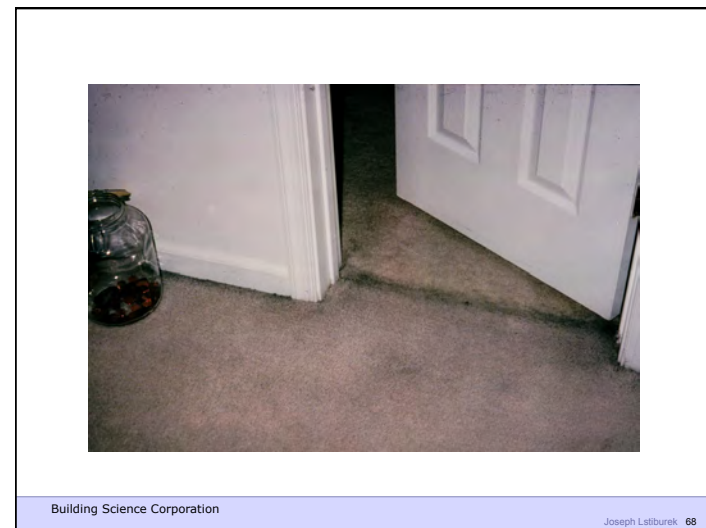
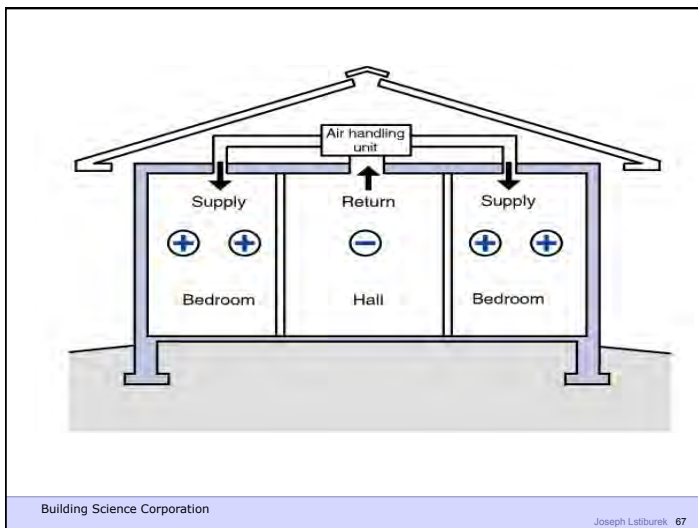

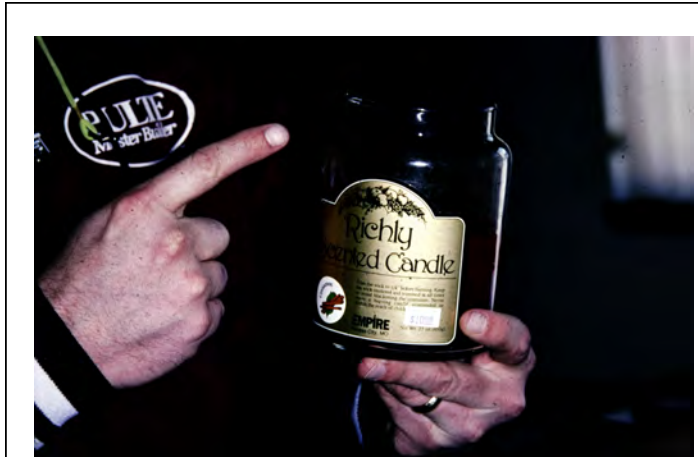

Building Science Corporation

Joseph Lstiburek 69



Building Science Corporation

Joseph Lstiburek 70

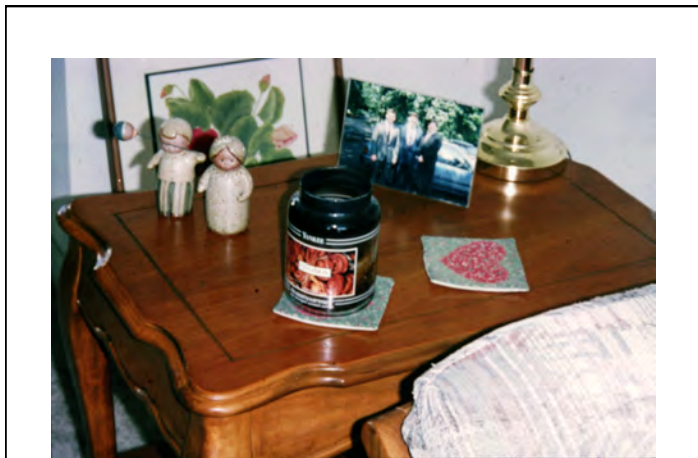

Building Science Corporation

Joseph Lstiburek 71



Building Science Corporation

Joseph Lstiburek 72

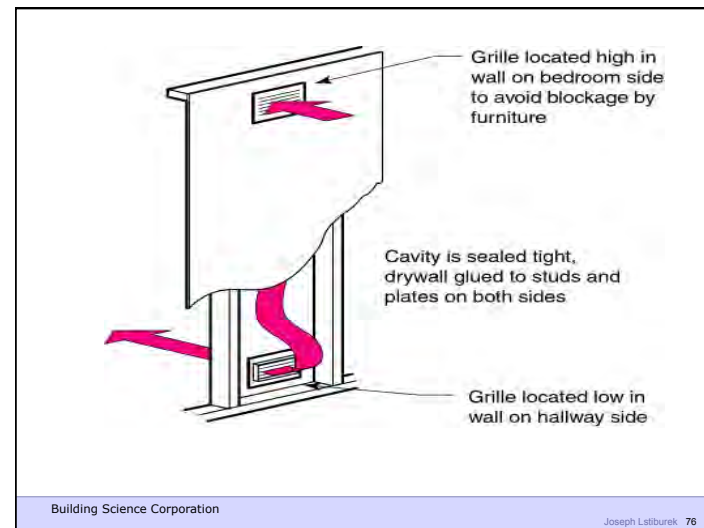



Building Science Corporation

Joseph Lstiburek 77

